

**CONEXIONES**  
**CONNECTIONS**  
**CONNECTIQUE**

---

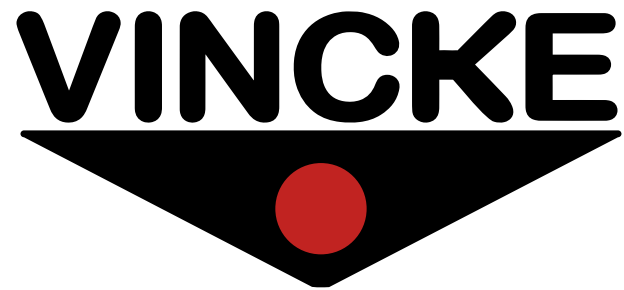



**TARIFA / PRICE LIST / TARIF**  
**AS0026**



your Hydraulic Brand

Las conexiones hidráulicas permiten la unión entre mangueras, racores y componentes hidráulicos, conectando las máquinas industriales y completando sistemas capaces de transmitir la potencia necesaria. Para garantizar un funcionamiento fiable, deben ser fáciles de ensamblar, y ofrecer alta resistencia a la presión y a la corrosión.

La compatibilidad entre las mangueras y sus conexiones es esencial para lograr un rendimiento óptimo y asegurar la continuidad de los procesos industriales.

Las conexiones Vincke destacan por su amplia gama y versatilidad, con más de 4.500 referencias que incluyen mangueras, racores, enchufes y válvulas hidráulicas, compatibles con los principales estándares internacionales y adaptadas a las especificaciones de nuestros clientes OEM.

Según el tipo de sistema hidráulico y el equipo industrial, existen diferentes tipos de conexiones que Vincke comercializa, ofreciendo soluciones adecuadas a cada necesidad.

Hydraulic connections link hoses, fittings, and hydraulic components, enabling industrial machines to transmit the required power through complete and efficient hydraulic systems. To ensure reliable performance, they must be easy to assemble, and highly resistant to pressure and corrosion.

Compatibility between hoses and fittings is crucial to ensure the system operates safely and efficiently, supporting critical industrial production processes.

Vincke connections are known for their extensive range and versatility, with over 4.500 references including hoses, fittings, couplings, and hydraulic valves. They are compatible with most international standards and tailored to the specific requirements of our key OEM customers.

Depending on the hydraulic system and industrial equipment, Vincke offers a wide variety of hydraulic connection types, providing the right solution for every application.

*Les connexions hydrauliques assurent le lien entre tuyaux, raccords et composants hydrauliques, permettant aux machines industrielles de transmettre la puissance requise dans des systèmes hydrauliques complets et efficaces. Pour garantir leur bon fonctionnement, elles doivent être faciles à assembler, tout en étant résistantes à la pression et à la corrosion.*

*Il est essentiel que les tuyaux hydrauliques et leurs connexions soient compatibles, afin d'assurer un fonctionnement fiable des systèmes de production industriels.*

*Les connexions Vincke se distinguent par leur large gamme et leur grande polyvalence, avec plus de 4.500 références incluant des tuyaux, raccords, coupleurs et valves hydrauliques. Elles sont compatibles avec la majorité des normes internationales et s'adaptent aux besoins spécifiques de nos principaux clients OEM.*

*Selon les équipements et les systèmes hydrauliques utilisés, Vincke propose différents types de connexions hydrauliques, adaptés à chaque application.*

# VINCKE CONEXIONES HIDRÁULICAS

## VINCKE HYDRAULIC CONNECTIONS VINCKE CONNECTIQUE HYDRAULIQUES



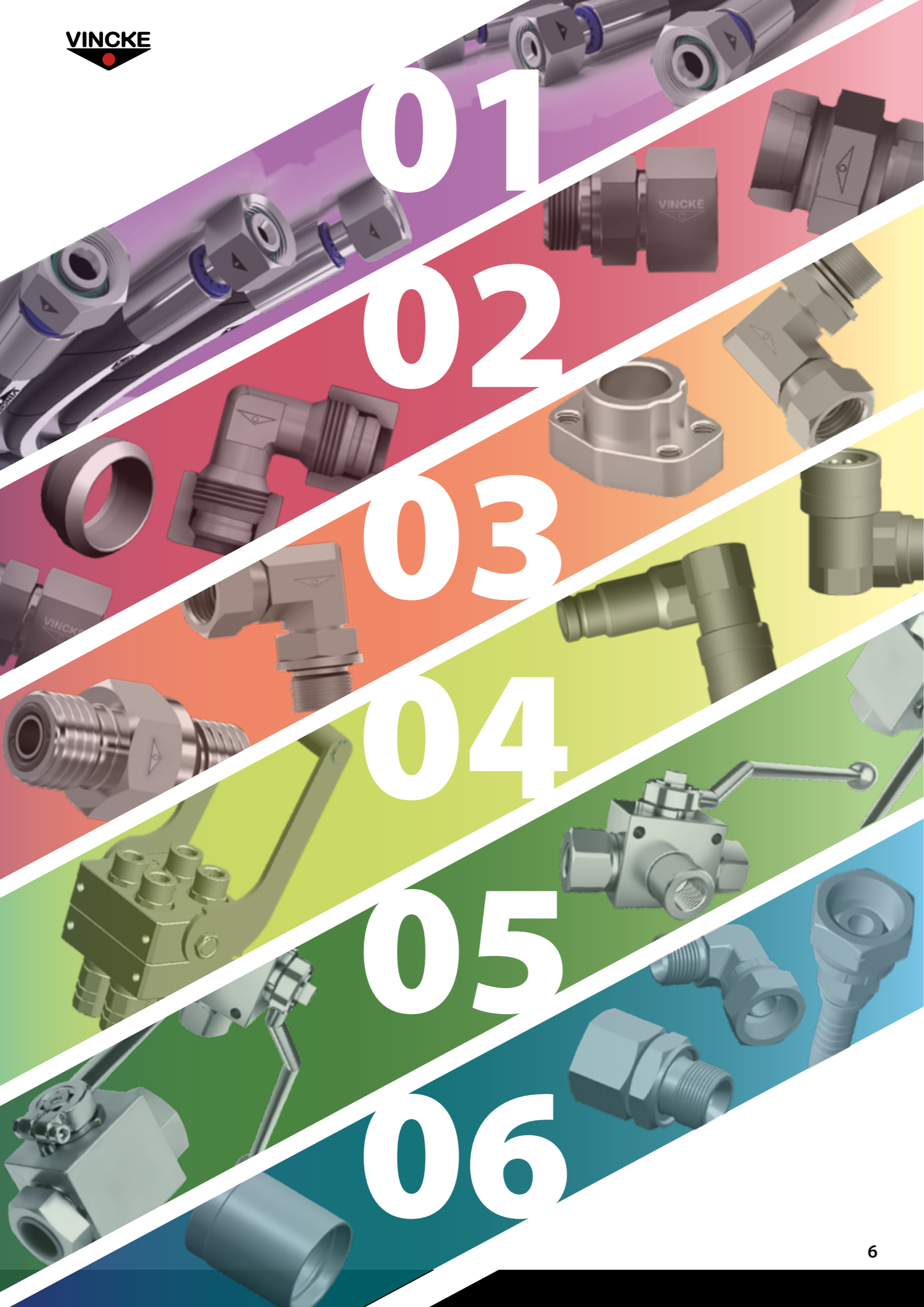

01

02

03

04

05

06

**MANGUERAS Y SUS CONEXIONES**  
 HOSES AND FITTINGS  
 TUYAUX ET RACCORDS  
**PÁG 11**

01

**CONEXIONES PARA TUBO RÍGIDO**  
 PIPE CONNECTORS  
 CONNECTIQUE POUR TUYAUX RIGIDE  
**PÁG 119**

02

**ADAPTADORES**  
 ADAPTERS  
 ADAPTEURS  
**PÁG 169**

03

**ENCHUFES RÁPIDOS**  
 QUICK RELEASE COUPLINGS  
 COUPLEURS RAPIDES  
**PÁG 203**

04

**VÁLVULAS HIDRÁULICAS ALTA PRESIÓN**  
 HIGH PRESSURE HYDRAULIC VALVES  
 VALVES HYDRAULIQUES HAUTE PRESSION  
**PÁG 229**

05

**RACORES INOXIDABLES AISI 316L VINCKE**  
 VINCKE STAINLESS STEEL FITTINGS AISI 316L  
 RACCORDS EN ACIER INOX AISI 316L VINCKE  
**PÁG 235**

06

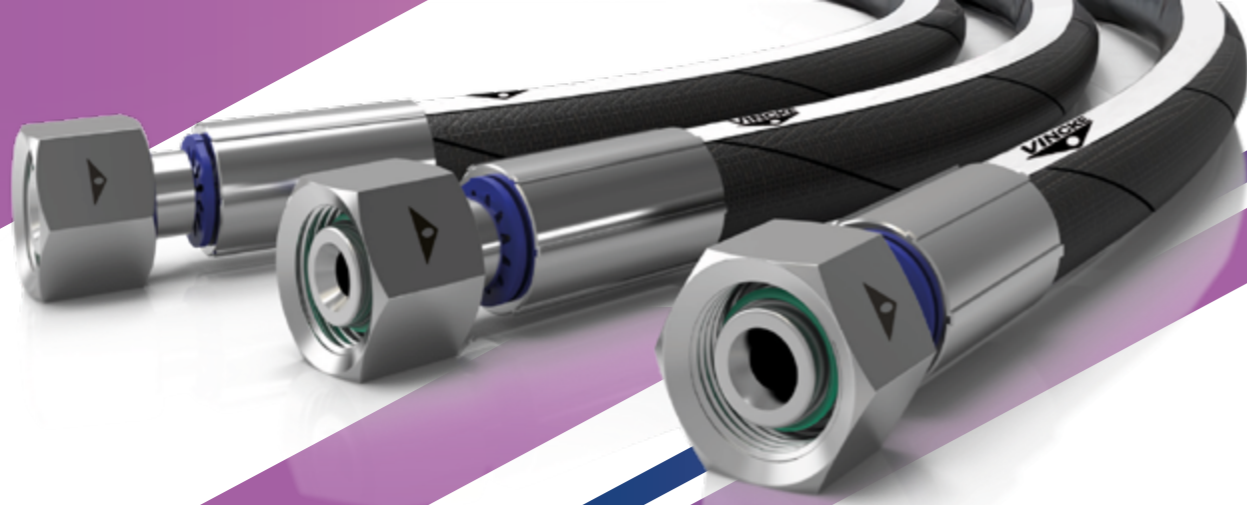

Las mangueras hidráulicas Vincke y sus conexiones prensadas están diseñadas para ofrecer máximo rendimiento, seguridad y durabilidad en todo tipo de aplicaciones. Una gran ventaja de nuestro sistema es que no requiere pelado de la manguera, ni interno ni externo, lo que hace el montaje más rápido, cómodo y seguro, manteniendo la integridad del flexible.

En Vincke ensamblamos más de 200.000 latiguillos al año, tanto en grandes como pequeñas series. Ofrecemos un servicio ágil y flexible, adaptado a cada necesidad.

Nuestros procesos cumplen con la exigente norma DIN 20066, lo que garantiza una manguera hidráulica ensamblada con calidad y fiabilidad total. Gracias a nuestra experiencia, innovación y control de calidad, somos un referente en soluciones hidráulicas ensambladas.

Vincke hydraulic hoses and their crimped fittings are engineered for maximum performance, safety, and durability across a wide range of applications. A key advantage of our system is that it requires no hose skiving — neither internal nor external — making the assembly process faster, cleaner, and more reliable, while preserving hose integrity.

At Vincke, we assemble over 200.000 hose assemblies per year, both in large production batches and small custom runs. We provide a fast and flexible assembly service, tailored to each client's needs.

Our operations follow the strict DIN 20066 standards, ensuring every hose is assembled to the highest quality and safety levels. With proven experience and rigorous quality control, we are a trusted provider of assembled hydraulic solutions.

*Les tuyaux hydrauliques Vincke et leurs raccords sertis sont conçus pour offrir performance, sécurité et longévité dans toutes les conditions.*

*L'un des grands avantages de notre système est qu'il ne nécessite aucun dénudage du tuyau, ni intérieur ni extérieur, ce qui rend l'assemblage plus rapide, plus simple et plus fiable, tout en préservant l'intégrité du flexible.*

*Chez Vincke, nous assemblons plus de 200.000 tuyaux par an, aussi bien en grandes séries qu'en petites productions sur mesure. Nous proposons un service d'assemblage rapide et adaptable, selon les besoins de chaque client.*

*Nous travaillons selon les normes strictes DIN 20066, garantissant un assemblage de haute qualité et entièrement sécurisé. Grâce à notre expertise et à notre exigence de qualité, Vincke est un acteur de référence dans le domaine des solutions hydrauliques assemblées.*

## MANGUERAS Y SUS CONEXIONES

### HOSES AND FITTINGS TUYAUX ET RACCORDS



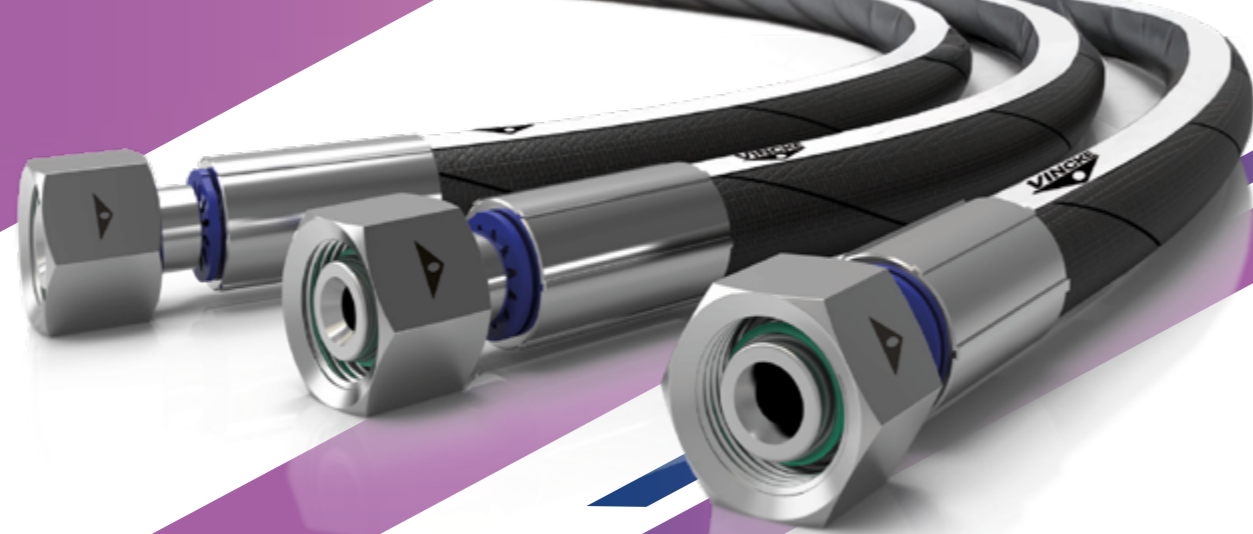

## **MANGUERAS Y SUS CONEXIONES**

**HOSES AND FITTINGS  
*TUYAUX ET RACCORDS***

**01** **MANGUERAS**  
HOSES  
*TUYAUX*  
PÁGINA 12

**02** **CONEXIONES PRENSAR ALTA  
ALTÍSIMA PRESIÓN**  
HIGH AND EXTREMELY HIGH  
CRIMPING FITTINGS  
*CONNEXIONS A SERTIR HAUTE/TRES  
HAUTE PRESSION*  
PÁGINA 40

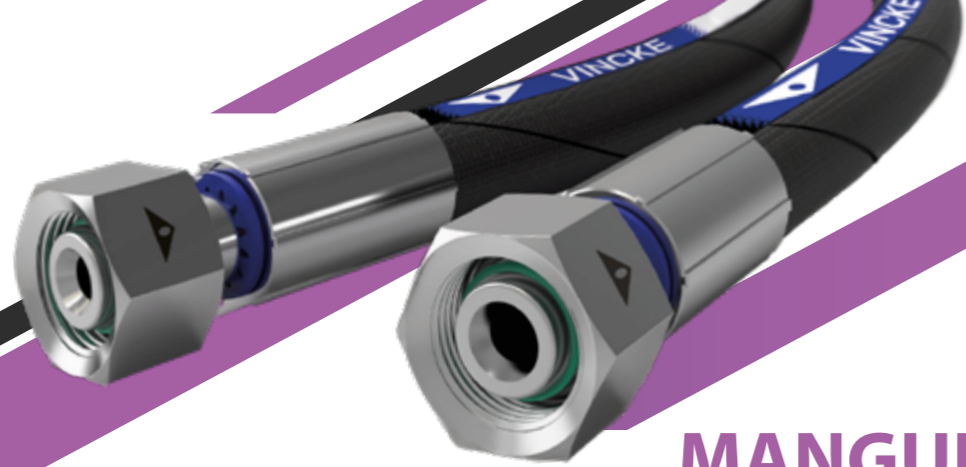

## MANGUERAS HOSES TUYAUX

La gama de mangueras hidráulicas Vincke ofrece una amplia selección de soluciones diseñadas para soportar aplicaciones hidráulicas generales y específicas. Desde sectores como la construcción, agricultura, minería, forestal y naval, nuestras mangueras están preparadas para rendir al máximo bajo condiciones exigentes. El mercado reconoce las mangueras Vincke por su excelente relación calidad-precio y su comportamiento fiable en condiciones extremas. Están fabricadas con materiales de alta calidad que garantizan una gran resistencia a la abrasión, radiación UV, ozono y agentes atmosféricos, asegurando un rendimiento duradero tanto en interiores como en exteriores. Gracias a su flexibilidad, resistencia a altas presiones y compatibilidad con racores Vincke, proporcionan un montaje rápido y seguro, sin necesidad de pelado. Cumplen y superan los requisitos ambientales y operativos más exigentes, ofreciendo una larga vida útil y un rendimiento constante en todo tipo de entornos. Con Vincke, obtienes una manguera hidráulica fiable, robusta y competitiva.

The Vincke hydraulic hose range offers a broad selection of products designed to withstand both general-purpose and specialized hydraulic applications. From construction and agriculture to mining, forestry, and marine industries, Vincke hoses are engineered to deliver reliable performance in demanding environments. Recognized in the market for their excellent price-performance ratio, Vincke hoses are built with high-quality materials that provide exceptional resistance to abrasion, UV radiation, ozone, and other environmental agents, making them ideal for both indoor and outdoor use. They combine flexibility, high-pressure resistance, and perfect compatibility with Vincke fittings — enabling quick, safe assembly without skiving. Our hoses meet and exceed strict operational and environmental standards, ensuring long service life and consistent performance. With Vincke, you get a durable, high-quality, and cost-effective hydraulic hose solution you can trust.

La gamme de tuyaux hydrauliques

Vincke propose une large sélection de produits conçus pour répondre aux besoins des applications hydrauliques standards ou spécifiques. Du secteur du BTP, de l'agriculture, de la mine, de la forêt ou encore du maritime, nos tuyaux garantissent des performances fiables dans des environnements exigeants. Reconnus pour leur excellent rapport qualité-prix, les tuyaux Vincke sont fabriqués avec des matériaux de haute qualité offrant une résistance élevée à l'abrasion, aux rayons UV, à l'ozone et aux agents atmosphériques, ce qui les rend adaptés à une utilisation intérieure comme extérieure. Ils se distinguent par leur grande flexibilité, leur résistance à haute pression et leur compatibilité parfaite avec les raccords Vincke, permettant un assemblage rapide, sûr et sans dénudage. Conformés et souvent supérieurs aux exigences environnementales et opérationnelles, nos tuyaux garantissent une longue durée de vie et des performances constantes. Avec Vincke, vous choisissez une solution hydraulique fiable, robuste et accessible.

**01 MANGUERAS HIDRÁULICAS**  
HYDRAULIC HOSES  
TUYAUX HYDRAULIQUES  
PÁGINA 14

**02 MANGUERAS DIAMOND RESISTENCIA ABRASIÓN**  
DIAMOND HOSES BRASION RESISTENCE  
TUYAU DIAMOND RÉSISTENCE À L'ABRASION  
PÁGINA 26

**03 MANGUERAS TERMOPLÁSTICA**  
THERMOPLASTIC HOSE  
TUYAUX THERMOPLASTIQUES  
PÁGINA 27

**04 MANGUERAS PTFE/ INOX**  
PTFE HOSES/ STAINLESS STEEL HOSES  
TUYAUX PTFE/ INOXYDABLES  
PÁGINA 34

**05 MANGUERAS BAJA PRESIÓN**  
LOW PRESSURE HOSES  
TUYAUX BASSE PRESSION  
PÁGINA 37

**06 PROTECCIÓN MANGUERAS**  
HOSES PROTECTION  
PROTECTION TUYAUX  
PÁGINA 39

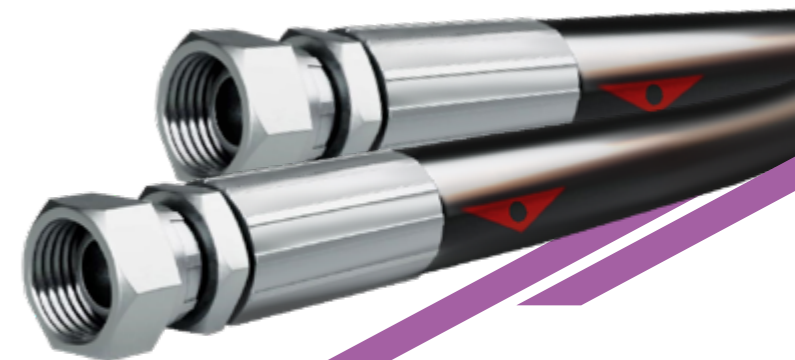

**MANGUERAS HIDRÁULICAS VINCKE**  
VINCKE HYDRAULIC HOSES  
TUYAUX HYDRAULIQUES VINCKE

MANGUERAS TRENZADAS  
BRAID HOSES  
TUYAUX TRESSÉS

**EN 853 1SN / SAE 100 R1T MSHA**  
EN 853 1SN / SAE 100 R1T MSHA  
EN 853 1SN / SAE 100 R1T MSHA



Ref.	∅	⌚	📏	🔥	€
MSL11.04	6,4x14	225	1/4	900	10,77
MSL11.05	8x15,5	215	5/16	850	11,17
MSL11.06	9,5x17,5	180	3/8	720	11,50
MSL11.08	12,7x21	160	1/2	640	13,28
MSL11.10	16x23,7	130	5/8	520	16,05
MSL11.12	19x27,7	105	3/4	420	20,77
MSL11.16	25,4x36	88	1"	350	25,99
MSL11.20	32x43,5	63	1" 1/4	250	35,97
MSL11.24	38x50	50	1" 1/2	200	50,55
MSL11.32	50,8x63,5	40	2"	160	65,65

**EN 853 1SN HT/ SAE 100 R1T 135° MSHA**  
EN 853 1SN HT/ SAE 100 R1T 135° MSHA  
EN 853 1SN HT/ SAE 100 R1T 135°



Ref.	∅	⌚	📏	🔥	€
MAN1512	19x27,7	105	3/4	420	42,43
MAN1516	25,4x35,6	88	1"	350	57,83
MAN1520	31,8x43,5	63	1" 1/4	250	76,86
MAN1524	38,1x51	50	1" 1/2	200	80,15
MAN1532	50,8x64,5	40	2"	160	100,94

**EN 853 2SN / SAE 100 R2T MSHA**  
EN 853 2SN / SAE 100 R2T MSHA  
EN 853 2SN / SAE 100 R2T MSHA



Ref.	∅	⌚	📏	🔥	€
MSL22.04	6,4x15,5	400	1/4	1600	12,83
MSL22.05	8x16,5	350	5/16	1400	14,07
MSL22.06	9,5x19,5	330	3/8	1320	14,48
MSL22.08	12,7x22,5	275	1/2	1100	16,79
MSL22.10	16x25,5	250	5/8	1000	21,28
MSL22.12	19x29,5	215	3/4	860	23,67
MSL22.16	25,4x38	165	1"	660	34,23
MSL22.20	32x48	125	1" 1/4	500	52,23
MSL22.24	38x55	90	1" 1/2	360	69,11
MSL22.32	50,8x68,6	80	2"	320	104,17
MSL22.40	63,5x80	70	2" 1/2	280	152,53
MSL22.48	76,2x93,4	55	3"	220	197,02

**R16 PLUS/2 ISO 1307 MSHA**  
R16 PLUS/2 ISO 1307 MSHA  
R16 PLUS/2 ISO 1307



Ref.	∅	⌚	📏	🔥	€
MSL14.04	6,4x14	350	1/4	1400	11,41
MSL14.05	8x15,4	300	5/16	1190	12,76
MSL14.06	9,5x16,5	280	3/8	1120	12,39
MSL14.08	12,7x21	245	1/2	980	14,64

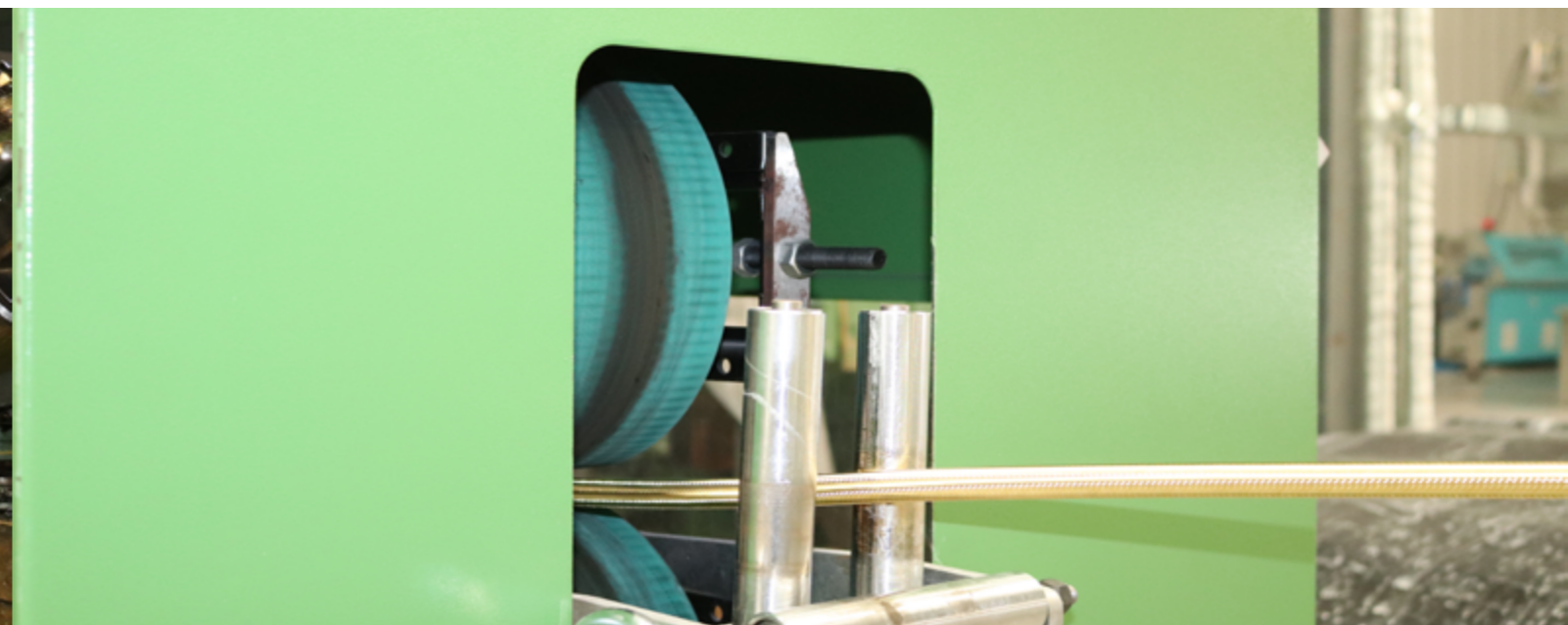
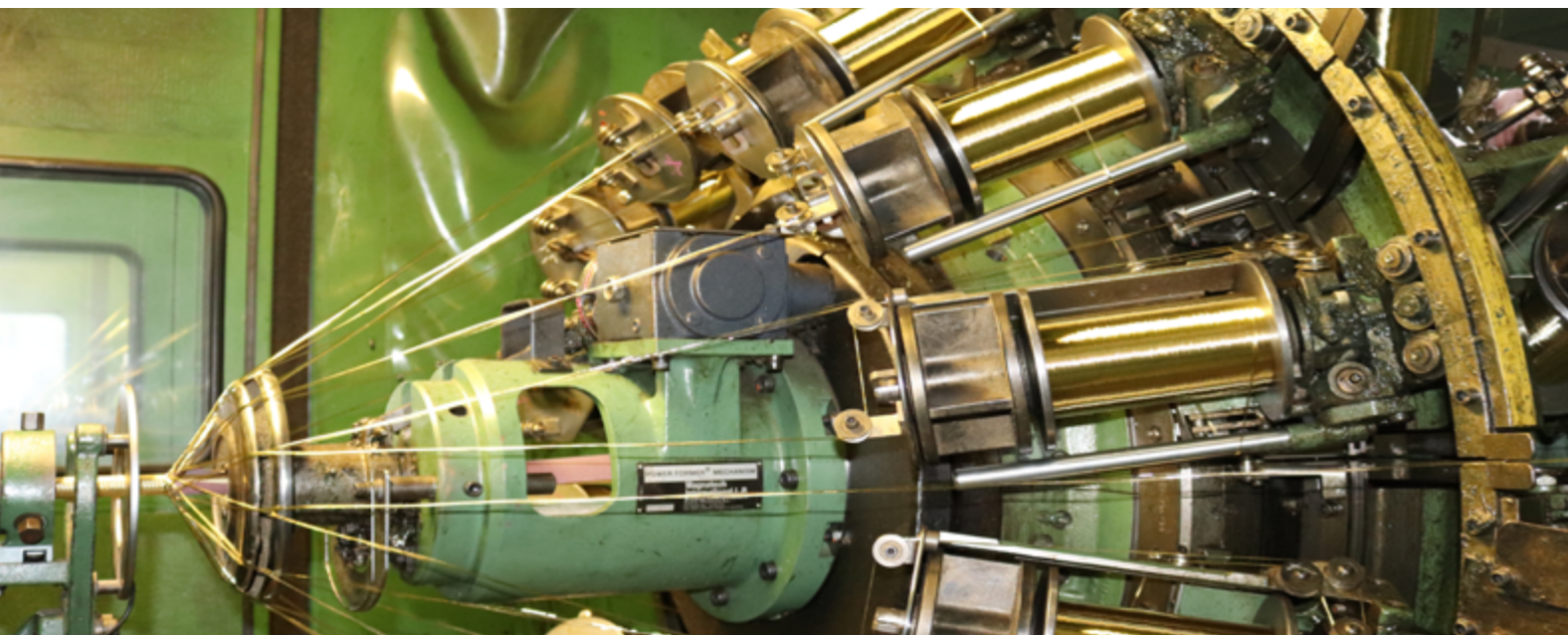

# MAN17 MAN24 MAN25

La solución SMOOTH en 1SC, 2SC y 2SNK está diseñada para una alta resistencia a la abrasión y a la intemperie de manguera a manguera en aplicaciones de flexión sin fricción y sin impacto. Compuesto por una capa de caucho sintético resistente con una capa exterior adicional de polietileno de ultra alto peso molecular (UHMWPE), su resistencia tanto a la abrasión como al ozono. De hecho, la resistencia a la abrasión de la cubierta SMOOTH 2SNK es perfecta para situaciones en las que un montón de mangueras rozan entre sí, y el acabado suave de la cubierta ofrece una alternativa fácil de limpiar a las protecciones de resorte.

The SMOOTH in 1SC, 2SC and 2SNK solution is designed for high hose to hose abrasion and weathering resistance in none friction flexing and non-impact applications. Comprising a tough synthetic rubber layer with an additional ultra-high molecular weight polyethylene (UHMWPE) outer skin, its resistance to both abrasion and ozone. In fact the abrasion resistance of SMOOTH 2SNK cover is perfect for situations where bunches of hoses rub against each other, and the smooth cover finish provides an easy-to-clean alternative to spring guards.

*La solution SMOOTH en 1SC, 2SC et 2SNK est conçue pour une résistance élevée à l'abrasion et aux intempéries de tuyau à tuyau dans des applications de flexion sans frottement et sans impact. Composé d'une couche de caoutchouc synthétique robuste avec une peau extérieure supplémentaire en polyéthylène à poids moléculaire ultra élevé (UHMWPE), sa résistance à la fois à l'abrasion et à l'ozone. En fait, la résistance à l'abrasion du revêtement SMOOTH 2SNK est parfaite pour les situations où des groupes de tuyaux se frottent les uns contre les autres, et la finition lisse du revêtement offre une alternative facile à nettoyer les protections à ressort.*

### EN 857 1SC SMOOTH MSHA

EN 857 1SC SMOOTH MSHA  
EN 857 1SC SMOOTH MSHA



Ref.	∅	⌚	📏	🌸	€
MAN17.03	5x11,6	250	3/16	1000	10,75
MAN1704S	6,4x12,5	225	1/4	900	11,88
MAN1705S	8x14	215	5/16	850	12,31
MAN1706S	9,5x16,4	180	3/8	740	12,68
MAN1708S	12,7x20	160	1/2	640	13,96
MAN1712S	19,3x26,2	105	3/4	420	23,91
MAN1716S	25,5x34,2	90	1	355	29,34

### EN 857 1SC BITUBO SMOOTH MSHA

EN 857 1SC TWIN SMOOTH MSHA  
EN 857 1SC JUMELÉ SMOOTH MSHA



Ref.	∅	⌚	📏	🌸	€
MAN1744S	5x11,6	250	3/16	1000	24,79
MAN1755S	6,4x12,5	225	1/4	900	25,52
MAN1766S	8x14	215	5/16	850	27,32

### EN 857 2SC SMOOTH MSHA

EN 857 2SC SMOOTH MSHA  
EN 857 2SC SMOOTH MSHA



Ref.	∅	⌚	📏	🌸	€
MAN2404S	6,4x13,2	420	1/4	1600	15,32
MAN2405S	8x15	380	5/16	1400	16,87
MAN2406S	9,5x17,1	350	3/8	1320	17,29
MAN2408S	12,7x20,7	310	1/2	1100	21,46
MAN2410S	16x23,8	280	5/8	1000	24,20
MAN2412S	19x27,7	275	3/4	860	26,90
MAN2416S	25,4x35,5	185	1"	660	38,98

### SUP-COMPACT 2SNK MSHA SMOOTH

SUP-COMPACT 2SNK MSHA SMOOTH  
SUP-COMPACT 2SNK MSHA IC-215/0 SMOOTH



Ref.	∅	⌚	📏	🌸	€
MAN2504	6,4x13,2	450	1/4	1800	17,85
MAN2505	8x15	420	5/16	1680	18,92
MAN2506	9,5x17,1	385	3/8	1540	19,55
MAN2508	12,7x20,3	345	1/2	1380	19,04
MAN2510	16x23,7	290	5/8	1160	27,74
MAN2512	19x27,7	280	3/4	1120	31,78
MAN2516	25,4x35,5	225	1"	800	47,16

### EN 857 2SC BITUBO SMOOTH MSHA

EN 857 2SC TWIN SMOOTH MSHA  
EN 857 2SC JUMELÉ SMOOTH MSHA



Ref.	∅	⌚	📏	🌸	€
MAN2444S	6,4x13,2	420	1/4	1600	33,64
MAN2455S	8x15	380	5/16	1400	36,23
MAN2466S	9,5x17,1	350	3/8	1320	37,26
MAN2488S	12,7x20,7	310	1/2	1100	46,58

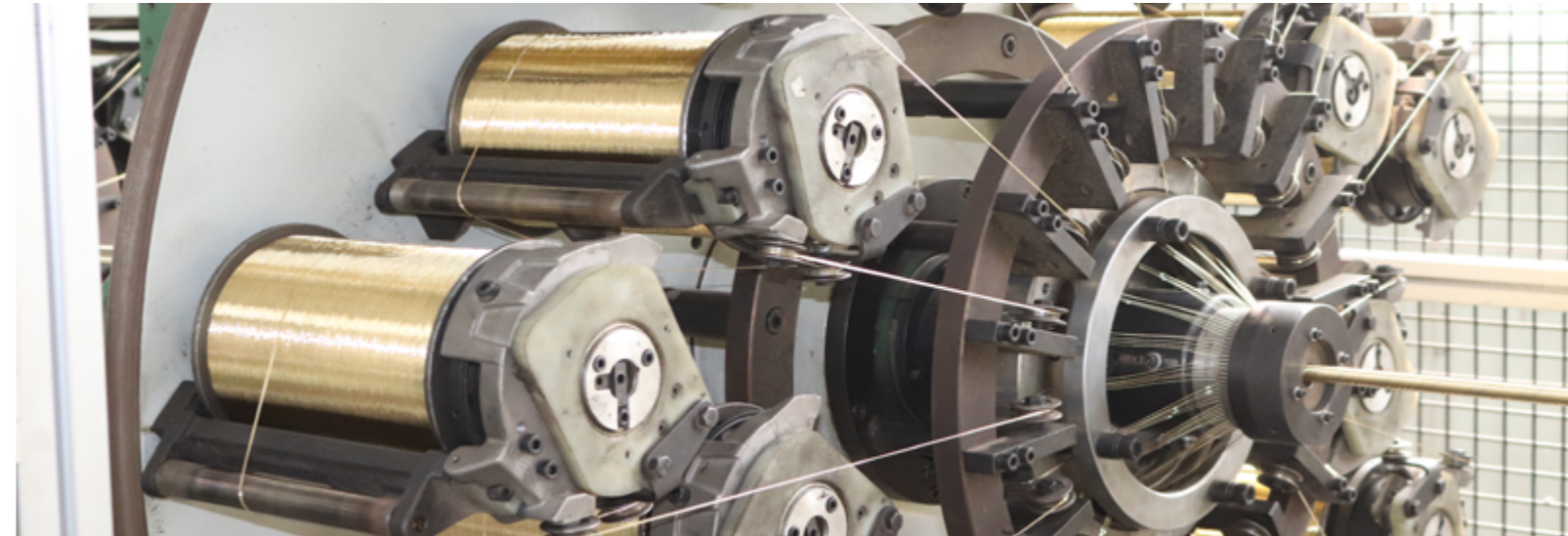

MULTIESPIRAL  
MULTISPIRAL  
MULTISPIRALE

### EN 856 4SP / SAE 100 R9R MSHA

EN 856 4SP / SAE 100 R9R MSHA  
EN 856 4SP / SAE 100 R9R

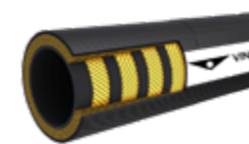

Ref.	∅	⌚	📏	🌸	€
MAN0904	6,4x17,6	450	1/4	1800	34,87
MAN0906	9,5x21,2	445	3/8	1780	38,01
MAN0908	12,7x24x4	415	1/2	1660	40,03
MAN0910	16x28	350	5/8	1400	42,28
MAN0912	19x32	350	3/4	1400	47,98
MAN0916	25,4x39,1	280	1"	1120	61,56

### EN 856 4SH MSHA

EN 856 4SH MSHA  
EN 856 4SH MSHA

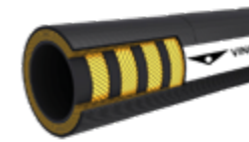

Ref.	∅	⌚	📏	🌸	€
MAN0412	19x32	420	3/4	1680	52,09
MAN0416	25,4x38,4	380	1"	1520	63,72
MAN0420	31,8x45,2	350	1" 1/4	1400	82,51
MAN0424	38,1x53	290	1" 1/2	1160	105,51
MAN0432	50,8x67,7	250	2"	1000	146,75

### 4SS+ 420BAR MSHA

4SS+ 420BAR MSHA  
4SS+ 420BAR MSHA

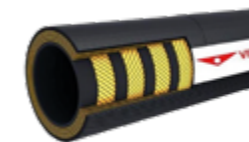

Ref.	∅	⌚	📏	🌸	€
MSL4S.08	12,7x23	420	1/2	1680	69,91
MSL4S.10	16x28,5	420	5/8	1680	73,72
MSL4S.12	19x30,1	420	3/4	1680	78,81
MSL4S.16	25,4x36,6	420	1"	1680	87,70
MSL4S.20	32x45	420	1"1/4	1680	116,94

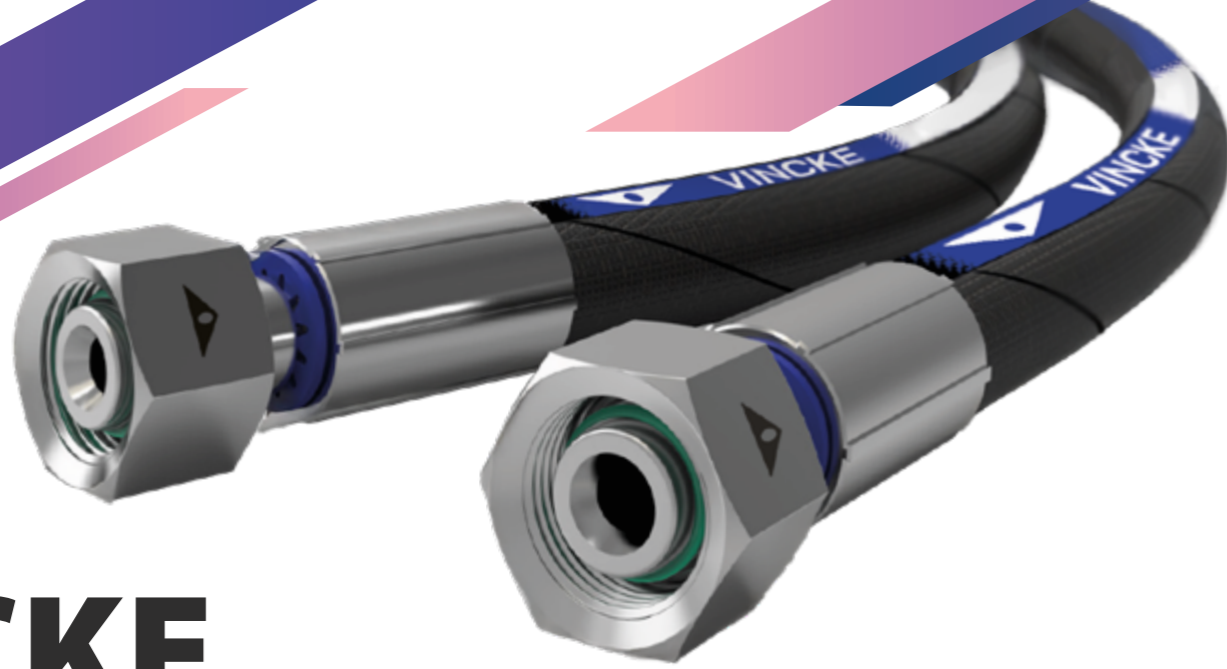

# VINCKE 4SS+/6SS+ NEOPRENO

## ¿QUÉ ES LA 4SS+/6SS+ NEOPRENO?

Es una manguera hidráulica de nueva generación. Está desarrollada para resistir condiciones extremas, picos de presión y entornos altamente abrasivos.

## APLICACIONES PRINCIPALES

- Sistemas hidráulicos de alta presión
- Equipos de construcción móvil
- Maquinaria minera
- Equipos agrícolas
- Circuitos hidráulicos exigentes en ambientes extremos

## CARACTERÍSTICAS TÉCNICAS

**Tubo interior:** Caucho sintético especial, compatible con aceites hidráulicos minerales, vegetales y a base de glicol.

**Refuerzo:** 4 o 6 espirales de alambre de acero de alta resistencia.

**Cubierta exterior:** Neopreno especial con resistencia extrema a la abrasión y a condiciones climáticas adversas.

**Rango de temperatura:** -40°C a +120°C.

## BENEFICIOS CLAVE

**RESISTENCIA SUPERIOR A LA ABRASIÓN Y EL CLIMA**

**Mayor flexibilidad:** Radio de curvatura mejorado hasta en 50% frente a estándares SAE.

**Facilidad de instalación:** Fuerza para doblar reducida en 40% respecto a mangueras estándar.

**Ideal para aplicaciones extremas:** Soporta picos de presión y operación continua en condiciones exigentes.

# VINCKE 4SS+/6SS+ NEOPRENE

## WHAT IS 4SS+/6SS+ NEOPRENE?

Is a next-generation hydraulic hose. It is designed to withstand extreme conditions, pressure spikes, and highly abrasive environments.

## MAIN APPLICATIONS

- High-pressure hydraulic systems
- Mobile construction equipment
- Mining machinery
- Agricultural equipment
- Demanding hydraulic circuits in harsh environments

# VINCKE 4SS+/6SS+ NÉOPRÈNE

## QU'EST-CE QUE LA 4SS+/6SS+ NÉOPRÈNE?

Est un tuyau hydraulique de nouvelle génération. Elle est conçue pour résister à des conditions extrêmes, aux pics de pression et aux environnements hautement abrasifs.

## APPLICATIONS PRINCIPALES

- Systèmes hydrauliques haute pression
- Équipements de construction mobiles
- Machines minières
- Équipements agricoles
- Circuits hydrauliques exigeants en environnements difficiles

## TECHNICAL FEATURES

**Inner tube:** Special synthetic rubber, compatible with mineral, vegetable, and glycol-based hydraulic oils

**Reinforcement:** 4 or 6 high-tensile steel wire spirals

**Outer cover:** Special neoprene with extreme abrasion and weather resistance

**Temperature range:** -40°C to +120°C

## KEY BENEFITS

### SUPERIOR ABRASION AND WEATHER RESISTANCE

**Increased flexibility:** Bend radius improved by up to 50% compared to SAE standard hoses

**Easier installation:** Force to bend reduced by 40% compared to standard hoses

**Perfect for extreme applications:** Withstands pressure spikes and continuous operation in demanding environments

## CARACTÉRISTIQUES TECHNIQUES

**Tube intérieur:** Caoutchouc synthétique spécial, compatible avec les huiles hydrauliques minérales, végétales et à base de glycol.

**Renforcement:** 4 ou 6 spirales de fil d'acier à haute résistance.

**Revêtement extérieur:** Néoprène spécial avec une résistance extrême à l'abrasion et aux intempéries.

**Plage de température:** -40°C à +120°

## AVANTAGES CLÉS

### RÉSISTANCE SUPÉRIEURE À L'ABRASION ET AUX INTEMPÉRIES

**Flexibilité accrue:** Rayon de courbure amélioré jusqu'à 50% par rapport aux normes SAE

**Installation facilitée:** Force de pliage réduite de 40% par rapport aux tuyaux standards

**Ideal pour les applications extrêmes:** Résiste aux pics de pression et fonctionne en continu dans des conditions exigeantes

**VINCKE 4SSN+ 420BAR MSHA**

VINCKE 4SSN+ 420BAR MSHA  
VINCKE 4SSN+ 420BAR MSHA

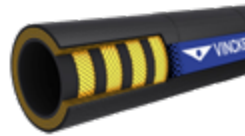

Ref.	∅	PSI	Length	Weight	€
MAN4S12	19x30,1	420	3/4	1680	83,03
MAN4S16	25,4x36x6	420	1"	1680	91,08

**VINCKE 6SSN+ 420BAR MSHA**

VINCKE 6SSN+ 420BAR MSHA  
VINCKE 6SSN+ 420BAR MSHA

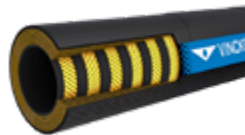

Ref.	∅	PSI	Length	Weight	€
MAN6S20	31,5x47,4	420	1"1/4	1680	170,78
MAN6S24	38x55,6	420	1"1/2	1680	212,18
MAN6S32	51x71,4	420	2	1680	263,93

**EN 856 R15 SAE 100 R15 MSHA**

EN 856 R15 SAE 100 R15 MSHA  
EN 856 R15 SAE 100 R15 MSHA IC-215/0 MSHA



Ref.	∅	PSI	Length	Weight	€
MAN42012	19x32	420	3/4	1680	56,93
MAN42016	25,4x38,4	420	1"	1680	79,70
MAN42020	31,8x49,3	420	1" 1/4	1680	165,60
MAN42024	38,1x57,3	420	1" 1/2	1680	204,93
MAN42032	50,8x72	420	2"	1680	258,75

**VIN-BLAST ALTA PRESIÓN 1100 BAR**

VIN-BLAST HIGH PRESSION 1100 BAR  
VIN-BLAST HAUTE PRESSION 1100 BAR

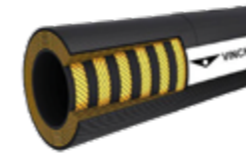

Ref.	∅	PSI	Length	Weight	€
MAN6608	12,7x27	1100	1/2	2750	56,67
MAN6612	19,1x36	1100	3/4	2750	81,09

**HIDROLAVADORA 2SC AZUL**

HYDROWASHING 2SC BLUE  
HYDRONETTOYAGE 2SC BLEU

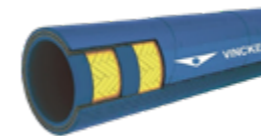

Ref.	∅	PSI	Length	Weight	€
MSL23.04	6,4x13,4	400	1/4	1600	15,46
MSL23.05	8x15	400	5/16	1600	16,83
MSL23.06	9,5x17	400	3/8	1600	18,76
MSL23.08	12,7x20,7	300	1/2	1200	22,55

**EMPUÑADURA GOMA AZUL**

BLUE HYDRO-WASH HANDLE IN RUBBER  
POIGNÉE CAOUTCHOUC BLEUE



Ref.	Length	€
RAC0S7270004B	1/4	5,39
RAC0S7270005B	5/16	5,39
RAC0S7270006B	3/8	5,39

**FLEXIBLE SEWER SBR 250BAR**

ASSEMBLED HOSE SEWER SBR  
FLEXIBLE SEWER SBR 250BAR



Ref.	Long.	Length	€
CMPLA128044	100000	3/4	3958,88
CMPLA156397	120000	3/4	4750,65
CMPLA126935	160000	3/4	6334,20
CMPLA128049	100000	1	5806,35
CMPLA156398	120000	1	6970,73
CMPLA156399	160000	1	9290,16



# SEWER CLEANNING 250BAR

**Tubo:** Caucho sintético especial.  
**Refuerzo:** Trenza aramida de alta resistencia a la tracción.  
**Cubierta:** Lisa, resistente a la abrasión, al aceite y a la intemperie, de caucho sintético especial.  
**Aplicación:** Para limpieza y enjuague de sistemas de alcantarillado a alta presión.

**Conexiones:** Macho-Hembra giratoria 60° B SP  
**Especificación:** ISO 1307  
 Todos los flexibles están probados previamente a presión y vienen con conectores macho-hembra.

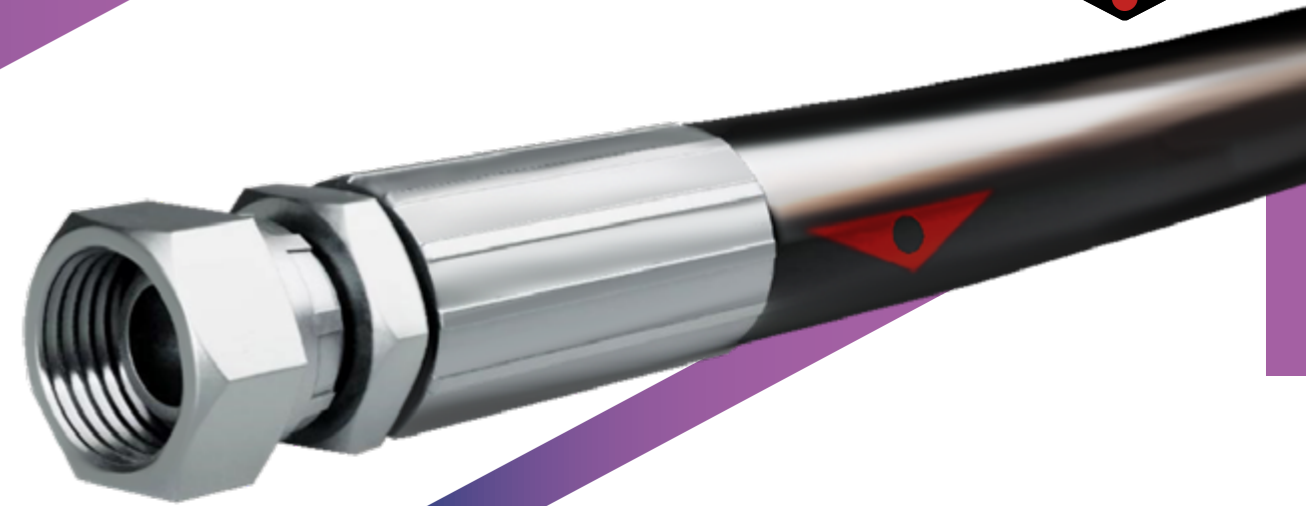

**Tube:** Caoutchouc synthétique spécial.  
**Renforcement:** Tresse en aramide à haute résistance à la traction.  
**Revêtement:** Lisse, résistant à l'abrasion, à l'huile et aux intempéries, en caoutchouc synthétique spécial.  
**Application:** Pour le nettoyage et le rinçage à haute pression des systèmes d'égouts.

**Raccords:** Mâle - Femelle tournante, 60° BSP  
**Spécification:** ISO 1307

Tous les assemblages sont testés sous pression à l'avance et sont fournis avec des raccords mâle-femelle.

**Tube:** Caoutchouc synthétique spécial.  
**Renforcement:** Tresse en aramide à haute résistance à la traction.  
**Revêtement:** Lisse, résistant à l'abrasion, à l'huile et aux intempéries, en caoutchouc synthétique spécial.  
**Application:** Pour le nettoyage et le rinçage à haute pression des systèmes d'égouts.

**Raccords:** Mâle-Femelle tournante, 60° BSP  
**Spécification:** ISO 1307

Tous les assemblages sont testés sous pression à l'avance et sont fournis avec des raccords mâle-femelle.



**MANGUERAS DIAMOND RESISTENCIA ABRASIÓN**  
**DIAMOND HOSES BRASION RESISTANCE**  
**TUYAU DIAMOND RÉSISTENCE À L'ABRASION**



**EN 853 2SN / SAE 100 R2T DIAMOND RESISTENCIA ABRASIÓN MSHA**  
EN 853 2SN / SAE 100 R2T DIAMOND BRASION RESISTANCE MSHA  
EN 853 2SN / SAE 100 R2T DIAMOND RÉSISTENCE À L'ABRASION



Ref.	Ø	🕒	📏	👤	€
MSL22X.04	6,4x15,5	400	1/4	1600	16,04
MSL22X.05	8x16,5	350	5/16	1400	14,83
MSL22X.06	9,5x19,5	330	3/8	1320	18,09
MSL22X.08	12,7x22,5	275	1/2	1100	21,01
MSL22X.10	16x25,5	250	5/8	1000	26,59
MSL22X.12	19x29,5	215	3/4	860	29,58
MSL22X.16	25,4x38	165	1"	660	42,80
MSL22X.20	32x48	125	1" 1/4	500	63,21
MSL22X.24	38x55	90	1" 1/2	360	83,45
MSL22X.32	50,8x68,6	80	2"	320	129,79

**EN 857 2SC SMOOTH DIAMOND RESISTENCIA ABRASIÓN MSHA**  
EN 857 2SC SMOOTH DIAMOND BRASION RESISTANCE MSHA  
EN 857 2SC SMOOTH DIAMOND RÉSISTENCE À L'ABRASION



Ref.	Ø	🕒	📏	👤	€
MAN24X04	6,4x13,2	420	1/4	1600	17,45
MAN24X05	8x15	380	5/16	1400	18,06
MAN24X06	9,5x17,1	350	3/8	1320	19,26
MAN24X08	12,7x20,7	310	1/2	860	22,19
MAN24X12	19x27,7	275	3/4	660	30,70
MAN24X16	25,4x35,5	185	1"		38,31

**EN 856 4SH DIAMOND RESISTENCIA ABRASIÓN**  
EN 856 4SH DIAMOND ABRASION RESISTANCE  
EN 856 4SH DIAMOND RÉSISTENCE À L'ABRASION



Ref.	Ø	🕒	📏	👤	€
MSL04X.12	19x32	420	3/4	1680	75,06
MSL04X.16	25,4x38,4	380	1"	1520	107,15
MSL04X.20	31,8x45,2	350	1" 1/4	1400	103,14
MSL04X.24	48x8x53	290	1" 1/2	1160	142,78

**HIDROLAVADORA 2SC DIAMOND AZUL RESISTENCIA ABRASIÓN MSHA**  
HYDROWASHING BLUE DIAMOND 2SC ABRASION RESISTANCE MSHA  
NETTOYAGE 2SC BLEU DIAMOND RÉSISTENCE À L'ABRASION

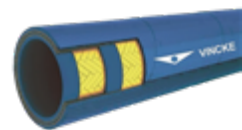

Ref.	Ø	🕒	📏	👤	€
MSL23X.04	6,4x13,4	400	1/4	1600	18,84
MSL23X.05	8x15	400	5/16	1600	107,15
MSL23X.06	9,5x17	400	3/8	1600	103,14
MSL23X.08	12,7x20,7	300	1/2	1200	142,78

**MANGUERA TERMOPLÁSTICA VINCKE**  
**VINCKE THERMOPLASTIC HOSE**  
**TUYAU THERMOPLASTIQUE VINCKE**

**EN 855 SAE 100 R7**  
EN 855 SAE 100 R7  
EN 855 SAE 100 R7



Ref.	Ø	🕒	📏	👤	€
MSL0702	3,2x8,2	210	1/8	840	4,80
MSL0703	4,8x10	210	3/16	840	5,21
MSL0704	6,6x11,8	200	1/4	800	6,07
MSL0705	8,18x14,3	190	5/16	760	9,41
MSL0706	9,65x16	175	3/8	700	9,92
MSL0708	12,7x20,3	140	1/2	560	13,33
MSL0710	16x23,5	105	5/8	420	17,18
MSL0712	19x26,5	90	3/4	360	19,41
MSL0716	25,5x33,3	70	1"	280	28,71

**EN 855 SAE 100 R7 BITUBO**  
EN 855 SAE 100 R7 TWIN  
EN 855 SAE 100 R7 JUMELÉ



Ref.	Ø	🕒	📏	👤	€
MSL0733	4,8x10	210	3/16	840	9,57
MSL0744	6,6x11,8	200	1/4	800	16,56
MSL0755	8,18x14,3	190	5/16	760	19,67
MSL0766	9,65x16	175	3/8	700	21,54
MSL0788	12,7x20,3	140	1/2	560	28,01

**SAE 100 R18**  
SAE 100 R18  
SAE 100 R18



Ref.	Ø	🕒	📏	👤	€
MSL1804	6,6x12,7	250	1/4	1000	6,25

**EN 855 SAE 100 R7V (DISOLVENTES, PINTURAS...)**  
EN 855 SAE 100 R7V (SOLVENTS, PAINTS...)  
EN 855 SAE 100 R7V (SOLVANTS, PEINTURES...)



Ref.	Ø	🕒	📏	👤	€
MSL07VE74	6,6x11,8	200	1/4	800	7,01
MSL07VE75	8,18x14,3	190	5/16	760	8,29
MSL07VE76	9,65x16	175	3/8	700	8,55
MSL07VE78	12,7x20,3	140	1/2	560	14,45

**EN 855 SAE 100 R8 (DISOLVENTES, PINTURAS..)**

EN 855 SAE 100 R8 (SOLVENTS, PAINTS...)  
EN 855 SAE 100 R8 (SOLVANTS, PEINTURES...)



Ref.	Ø	⌚	📏	👤	€
MSL0803Z	4,8x10	350	3/16	1400	13,91
MSL0804Z	6,6x11,8	350	1/4	1400	21,76
MSL0805Z	8,18x14,3	300	5/16	1200	28,82
MSL0806Z	9,65x16	280	3/8	1120	32,91
MSL0808Z	12,7x20,3	245	1/2	980	38,68

**EN 855 SAE 100 R8 NO CONDUCTIVA**

EN 855 SAE 100 R8 NON-CONDUCTIVA  
EN 855 SAE 100 R8 NON CONDUCTEUR



Ref.	⌚	📏	👤	€
MSL0804NC	350	1/4	1400	24,95
MSL0806NC	280	3/8	1120	35,07
MSL0808NC	245	1/2	980	40,35

**EN 855 SAE 100 R8 DOBLE**

EN 855 SAE 100 R8 TWIN  
EN 855 SAE 100 R8 JUMELÉ



Ref.	Ø	⌚	📏	👤	€
MSL0844Z	6,6x12,4	350	1/4	1400	35,74
MSL0855Z	8,18x14,3	300	5/16	1200	44,98
MSL0866Z	9,65x16	280	3/8	1120	52,03
MSL0888Z	12,7x20,3	245	1/2	980	60,24

**TERMOPLÁSTICA 1 MALLA METÁLICA (DISOLVENTES, PINTURAS...)**

THERMOPLASTIC 1 STEEL BRAID ( SOLVENTS, PAINTS...)  
THERMOPLASTIQUE 1 TRESSE MÉTALLIQUE (SOLVANTS, PEINTURES...)



Ref.	Ø	⌚	📏	👤	€
MSL7703	4,8x9,7	350	3/16	1400	10,09
MSL7704	6,6x11,8	300	1/4	1200	8,55
MSL7705	8,18x14	240	5/16	960	9,83
MSL7706	9,65x16	225	3/8	900	13,09
MSL7708	12,7x19,2	190	1/2	760	19,05
MSL7710	16x23,3	150	5/8	600	18,81
MSL7712	19x26,5	130	3/4	520	29,92
MSL7716	25,5x32,5	105	1"	420	31,46

**TERMOPLÁSTICA 1 MALLA METÁLICA BITUBO**

THERMOPLASTIC TWIN 1 STEEL BRAID  
THERMOPLASTIQUE 1 TRESSE MÉTALLIQUE JUMELÉ



Ref.	Ø	⌚	📏	👤	€
MSL7733	4,8x9,7	350	3/16	1400	15,55
MSL7744	6,6x11,8	300	1/4	1200	16,06
MSL7755	8,18x14	240	5/16	960	26,49
MSL7766	9,65x16	225	3/8	900	24,23
MSL7788	12,7x19,2	190	1/2	760	30,51

**RECOMENDACIONES DE ENSAMBLAJE  
ASSEMBLY RECOMMENDATIONS  
RECOMMANDATIONS DE MONTAGE**

**Evitar torsión.**  
Avoid twisting the hose.  
Éviter la torsion du tuyau.

**Evitar instalar la manguera demasiado ajustada. Le recordamos que las normas DIN y SAE prevén que la manguera bajo presión puede alargarse (máx. 2%) o incluso acortarse. (máximo 4%).**  
Avoid installing the hose too tightly. We remind you that DIN and SAE standards provide that the hose under pressure can elongate (max. 2%) or even shorten. (maximum 4%).  
Évitez d'installer le tuyau trop serré. Nous vous rappelons que les normes DIN et SAE prévoient que le tuyau sous pression peut s'allonger (max. 2%) voire se raccourcir. (maximum 4%).

**En caso de movimiento, tenga especial cuidado para evitar torsiones, tensiones o abrasiones.**  
In case of movement, take special care to avoid twisting, straining or abrasions.  
En cas de mouvement, veillez tout particulièrement à éviter les torsions, déformations ou les abrasions.

**Elegir el tipo de montaje más adecuado para eliminar posiciones incorrectas.**  
To choose the most appropriate type of fitting in order to eliminate any incorrect positions.  
Choisir le type de montage le plus approprié afin d'éliminer les positions incorrectes.

**Verifique que la manguera, una vez instalada, no tenga un radio de curvatura menor que el informado en la ficha técnica.**  
Check that the hose, when installed, has not a smaller bending radius than reported in the respective data sheet.  
Vérifiez que le tuyau, une fois installé, n'a pas un rayon de courbure inférieur à celui indiqué dans la fiche technique respective.

**TERMOPLÁSTICA 2 MALLAS METÁLICAS ( DISOLVENTES PINTURAS..)**

TERMOPLASTIC 2 STEEL BRAIDS (SOLVENTS, PAINTS...)

THERMOPLASTIQUE 2 TRESSÉS MÉTALLIQUES ( SOLVANTS, PEINTURES...)



Ref.	Ø	⌚	📏	👤	€
MSL8804	6,6x13,5	450	1/4	1800	11,96
MSL8805	8,18x15,1	400	5/16	1600	15,57
MSL8806	9,65x17	380	3/8	1520	22,49
MSL8808	12,7x22	300	1/2	1200	25,04
MSL8810	16x24,5	210	5/8	840	34,37
MSL8812	19x27,5	160	3/4	640	48,76
MSL8816	25,5x35	150	1"	600	53,24

**TERMOPLÁSTICA 2 MALLAS METÁLICAS BITUBO**

TERMOPLASTIC TWIN 2 STEEL BRAIDS

THERMOPLASTIQUE 2 TRESSÉS MÉTALLIQUES JUMELÉ



Ref.	Ø	⌚	📏	👤	€
MSL8844	6,6x13,5	450	1/4	1800	28,79
MSL8855	8,18x15,1	400	5/16	1600	33,24
MSL8866	9,65x17	380	3/8	1520	35,65
MSL8888	12,7x22	300	1/2	1200	41,12



**MANGUERA CONTROL PRESIÓN TEST VINCKE**

PRESSURE CONTROL HOSE TEST VINCKE

TUYAU CONTRÔLE DE PRESSION TEST VINCKE



Ref.	⌚	📏	👤	€
MSL00702E	630	1/12	1890	6,79

**JACK HOSE 700 BAR**

JACK HOSE 700 BAR

JACK HOSE 700 BAR

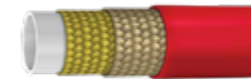

Ref.	Ø	⌚	📏	👤	€
MSL700-04	6,6x14,8	700	1/4	2800	37,21

**TERMOPLÁSTICA LAVADO AZUL**

HYDROWASHING THERMOP. BLUE

NETTOYAGE THERMOPLASTIQUE BLEU



Ref.	Ø	⌚	📏	👤	€
MSL07W04	6,4x12,8	210	1/4	525	13,61

**TERMOPLÁSTICA ALCANTARILLADO**

SEWER JET THERMOPLASTIC

HYDROCURAGE THERMOPLASTIQUE



Ref.	⌚	📏	👤	€
MSL08W08	280	1/2	690	26,39
MSL08W12	250	3/4	625	46,19
MSL08W16	250	1"	625	54,46

# TERMOPLÁSTICA LIMPIEZA ALCANTARILLADO

Manguera de limpieza de alcantarillado de alta resistencia con cubierta amarilla, apta para presiones de hasta 250 bar y temperaturas de funcionamiento entre -40°C y 60°C.

Diseñada específicamente para trabajar en ambientes húmedos sin degradarse, lo que garantiza una vida útil prolongada.

Alta resistencia al desgaste y durabilidad óptima.

Disponible con combinaciones de conexiones BSP y/o NPT RAPSJ.

## CARACTERÍSTICAS

- Excelente resistencia al corte y aplastamiento
- Disponible en largos continuos
- Aún más ligera
- Cubierta exterior resistente a ataques microbiológicos
- Radio de curvatura reducido
- Soporta altas velocidades de operación
- Baja pérdida de presión

## THERMOPLASTIC SEWER JET

Heavy-duty sewer cleaning hose designed for pressures up to 250bar and operating temperatures from -40°C to 60°C (-40°F to 140°F).

Specifically engineered for use in humid environments without degradation, ensuring extended service life.

Available with BSP and/or NPT fitting combinations (RAPSJ); other end terminations available upon request.

## CHARACTERISTICS

- Resistance and durability.
- Outstanding resistance to crushing and cutting
- Available in long lengths
- Even lighter weight
- Outer cover resistant to microbiological attack
- Reduced bending radius
- Supports high operating speeds
- Low pressure drop

## THERMOPLASTIC HYDROCURATION

Tuyau de nettoyage d'égouts haute performance, conçu pour des pressions allant jusqu'à 250 bar et des températures comprises entre -40 °C et 60 °C.

Spécialement conçu pour les environnements humides sans se dégrader, garantissant une durée de vie prolongée.

Disponible avec des raccords BSP et/ou NPT RAPSJ.

## CHARACTERISTIQUES

- Résistance à l'usure et une durabilité optimale
- Excellente résistance à l'écrasement et à la coupure
- Disponible en grandes longueurs
- Encore plus légère
- Gaine extérieure résistante aux attaques microbiologiques
- Rayon de courbure réduit
- Vitesse de fonctionnement élevée
- Faible perte de pression

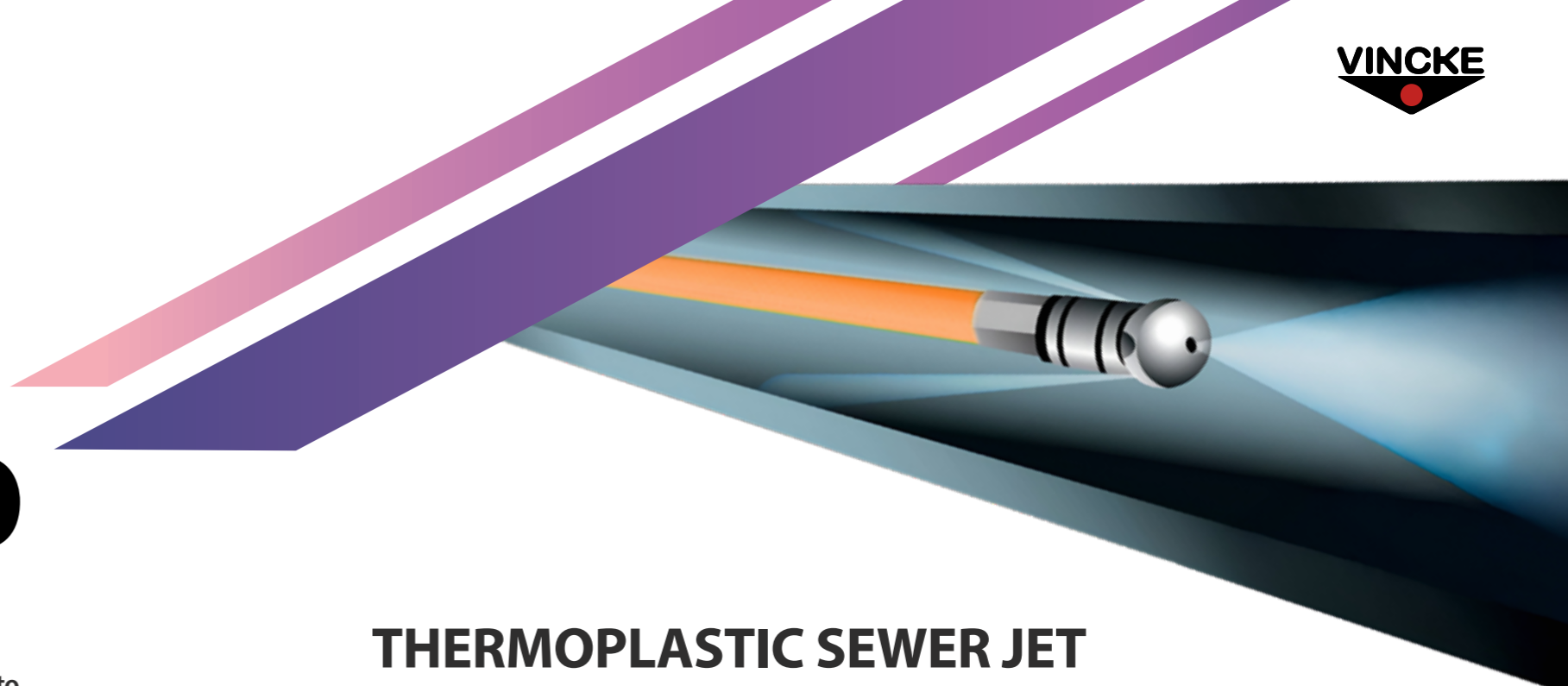

**MANGUERAS PTFE VINCKE**  
VINCKE PTFE HOSES  
TUYAU PTFE VINCKE

**PTFE COARRUGADO**  
PTFE CONVOLUTED HOSE  
TUY. PTFE ONDULÉ

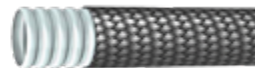

Ref.	∅	⌚	▬	✋	€
MAN9006	9,65x13,7	150	3/8	600	42,09
MAN9008	12,83x18,4	135	1/2	540	54,32
MAN9010	16x21	100	5/8	400	62,07
MAN9012	19,18x25,9	80	3/4	320	86,19
MAN9016	25,53x33,8	55	1"	220	111,64
MAN9020	31,88x48	45	1" 1/4	180	144,04
MAN9024	38,2x48	35	1" 1/2	140	166,14
MAN9032	50x,9x61,5	25	2"	100	214,39

**PTFE SAE J517 - 100R14**  
PTFE SAE J517 - 100R14  
PTFE SAE J517 - 100R14



Ref.	∅	⌚	▬	✋	€
MAN0802	3,2x5,6	260	1/8	1040	23,22
MAN0803	5x7,4	230	3/16	920	23,17
MAN0804	6,4x8,8	205	1/4	820	24,36
MAN0805	8x10,4	190	5/16	760	29,47
MAN0806	9,5x12	175	3/8	700	31,27
MAN0808	12,7x15,4	140	1/2	560	40,71
MAN0810	16x18,6	125	5/8	500	65,78
MAN0812	19x21,8	100	3/4	400	91,80
MAN0816	25,4x28,5	75	1"	300	98,86

**Vincke es un experto en el diseño y la fabricación de mangueras de acero inoxidable según las especificaciones del cliente y bajo la norma EN ISO 15614-1.**

Vincke is an expert in the design and fabrication of stainless steel hoses according to the customer's specifications and according to EN ISO 15614-1.

*Vincke est expert dans la conception et la fabrication de tuyaux en acier inoxydable selon les spécifications du client et respectant la norme EN ISO 15614-1.*

**MANGUERAS INOX CORRUGADO ISO 10380**  
CONVOLUTED STAINLESS STEEL HOSE ISO 10380  
TUYAUX INOX ONDULÉ ISO 10380

**MANGUERA INOX AISI 316-MALLA AISI 304 ISO 10380**  
CONVOLUTED STAINLESS STEEL HOSE AISI 316-BRAID AISI 304 ISO 10380  
TUYAU INOX ONDULÉ INOX AISI 316-TRESSE AISI 304



Ref.	⌚	▬	✋	€
MAI0104	120	1/4	480	9,97
MAI0106	97	3/8	388	13,77
MAI0108	75	1/2	300	14,63
MAI0110	60	5/8	240	24,63
MAI0112	62	3/4	248	29,60
MAI0116	50	1"	200	38,05
MAI0120	46	1" 1/4	184	47,63
MAI0124	42	1" 1/2	168	64,51
MAI0132	32	2"	128	86,73
MAI0140	30	2" 1/2	120	121,97
MAI0148	18	3"	72	131,73
MAI0164	16	4"	64	179,50
MAI0180	14	5"	56	288,37
MAI0196	10	6"	40	328,87

**MANGUERA INOX AISI 316-2 MALLAS AISI 304 ISO 10380**  
CONVOLUTED STAINLESS STEEL HOSE AISI 316-2 BRAIDS AISI 304 ISO 10380  
TUYAU INOX ONDULÉ INOX AISI 316-2 TRESSES AISI 304



Ref.	⌚	▬	✋	€
MAI0204	180	1/4	720	11,38
MAI0206	145,5	3/8	582	16,48
MAI0208	112	1/2	450	18,22
MAI0210	90	5/8	360	33,58
MAI0212	90	3/4	360	38,05
MAI0216	70	1"	300	48,90
MAI0220	69	1" 1/4	276	63,76
MAI0224	63	1" 1/2	252	91,08
MAI0232	48	2"	192	121,82
MAI0240	36	2" 1/2	144	148,00
MAI0248	27	3"	108	159,38
MAI0264	24	4"	96	222,00

# ¿CUANDO DEBEMOS UTILIZAR MANGUERAS INOXIDABLES CORRUGADAS?

IN WHICH CASES SHOULD CORRUGATED STAINLESS STEEL HOSES BE USED?

QUAND DOIT-ON UTILISER DES FLEXIBLES ONDULÉS EN ACIER INOXYDABLE?

**-TEMPERATURAS EXTREMAS**

Fría o caliente.

**-COMPATIBILIDAD QUÍMICA**

La manguera inoxidable puede soportar una variedad más amplia de productos químicos que la mayoría de los otros tipos de manguera.

**-PROBLEMAS DE PERMEACIÓN**

La manguera de inoxidable no permite la permeación.

**-PROBLEMAS DE ABRASIÓN Y DOBLADO EXCESIVO**

**-SEGURIDAD CONTRA INCENDIOS**

**-EXTREME TEMPERATURES**

cold or hot

**-CHEMICAL COMPATIBILITY**

stainless steel hoses are able to withstand a wider variety of chemical products than the majority of other types of hoses.

**-PERMEATION PROBLEMS**

stainless steel hoses prevent permeation.

**-ABRASION AND EXCESSIVE BENDING PROBLEMS**

**-FIRE PREVENTION**

**-TEMPÉRATURES EXTRÊMES**

Froid ou chaud.

**-COMPATIBILITÉ CHIMIQUE**

Les tuyaux en acier inoxydable peuvent résister à une plus grande variété de produits chimiques que la plupart des autres types de tuyaux.

**-PROBLÈMES DE PERMÉATION**

Le tuyau en acier inoxydable ne permet pas la perméation.

**-PROBLÈMES D'ABRASION ET DE FLEXION EXCESSIVE**

**-SÉCURITÉ INCENDIE**



## MANGUERAS BAJA PRESIÓN LOW PRESSURE HOSES TUYAUX BASSE PRESSION



**IMPULSIÓN EN 854 2TE SAE 100R6**

IMPULSION EN 854 2TE SAE 100R6  
IMPULSION EN 854 2TE SAE 100R6

Ref.	Ø	⌀	□	€
MAN0603	4,8X11,8	80	3/16	10,92
MAN0604	6,4X13,5	75	1/4	10,92
MAN0605	8x15	68	5/16	12,79
MAN0606	9,5x17,4	63	3/8	13,25
MAN0608	12,7X19,7	58	1/2	14,47
MAN0610	16X24	50	5/8	20,18
MAN0612	19X27	45	3/4	28,20
MAN0616	25,4X34,4	40	1"	37,25

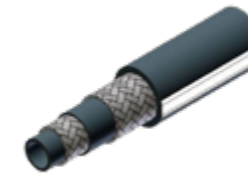

**IMPULSIÓN VOR**

IMPULSION VOR  
IMPULSION VOR

Ref.	Ø	⌀	□	€
MAN0620	32X45	20	1" 1/4	62,08
MAN0624	38X51	20	1" 1/2	72,34
MAN0632	50X65	20	2"	102,34
MAN0640	63X79	20	2" 1/2	147,25
MAN0650	76X92	20	3"	175,68/
MAN0660	102X120	20	4"	290,61



**ASPIRACIÓN SAEJ 517 R4**

SUCTION SAEJ 517 R4  
ASPIRATION SAEJ 517 R4

Ref.	Ø	⌀	□	€
MAN5512	19x29	21	3/4	42,26
MAN5516	25,4X37,4	17	1"	45,54
MAN5520	31,8x45	14	1" 1/4	49,68
MAN5524	38,1x52	10	1" 1/2	56,24
MAN5532	50,8x64	7	2"	68,40
MAN5540	63,5x77	4	2" 1/2	99,07
MAN5548	76,2x90	4	3"	102,82
MAN5564	101,6x116	2	4"	133,20

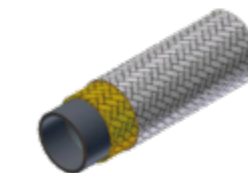

**VISO CAUCHO + TRENZA GALVÁNICA**

VISO RUBBER + GALVANIC BRAID  
VISO CAOUTCHOUC + TRESSE GALVANISÉE

Ref.	Ø	⌀	€
MANV10510	5X10	25	6,81
MANV10612	6x11	25	7,13
MANV10713	7X13	21	7,39
MANV10814	8X13	25	8,56
MANV10916	9X16	25	9,62
MANV11220	13x19	20	13,61

Ref.	Ø	⌀	€
MANV11524	16x22	20	17,57
MANV12029	20x29	15	31,32
MANV12535	25X33	15	38,17
MANV13040	30x40	10	42,04
MANV14052	40x52	10	83,46
MANV15062	50x62	10	111,30

**PROTECCIÓN MANGUERAS**  
**HOSES PROTECTION**  
**PROTECTION TUYAUX**



**ASPIRACION GRECA-10 ISO 1307**  
SUCTION GRECA-10 ISO 1307  
ASPIRATION GRECA-10 ISO 1307

Ref.	∅	Ref.	€
MANGR12	19x29	10	38,09
MANGR16	25x35	10	46,58
MANGR20	32x42	10	52,99
MANGR24	38x48	10	64,48
MANGR32	50x63	10	89,10
MANGR40	63x74	10	108,68

**GAD CAUCHO + TRENZA TEXTIL**  
GAD RUBBER + TEXTILE BRAID  
GAD CAOUTCHOUC + TRESSE TEXTILE

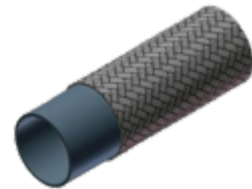

Ref.	∅	Ref.	€
MANGAD0307	3X7	10	7,30
MANGAD0408	4X8	10	6,44
MANGAD0511	5X11	10	6,60
MANGAD0612	6X12	10	8,09
MANGAD0813	8X13	10	9,32
MANGAD0916	9X13	10	10,11
MANGAD1218	12X18	10	14,36
MANGAD1422	14X22	10	15,24
MANGAD1930	19X30	10	25,60
MANGAD2537	25X37	10	32,11

**SINOX SILICONA + TRENZA INOX**  
SINOX SILICONE + STAINLESS STEEL BRAID  
SINOX SILICONE + TRESSE INOX

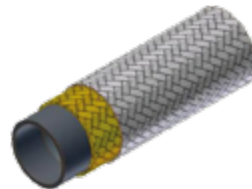

Ref.	∅	Ref.	€
MANSI0007	7X13	45	19,48
MANSI0008	8x14	40	27,49
MANSI0009	9X16	40	35,12
MANSI0012	12X20	35	46,00
MANSI0015	15X25	30	64,16
MANSI0019	19X30	25	98,83
MANSI0025	25X35	20	110,17

**SANITARIA EPDM + TRENZA INOX**  
EPDM SANITARY + STAINLESS STEEL BRAID  
SANITAIRE EPDM + TRESSE INOX

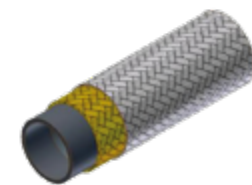

Ref.	∅	Ref.	€
MANSA0813	8X13	30	7,35
MANSA1320	13X20	20	23,48
MANSA1928	19X28	15	44,97
MANSA2535	25X35	10	59,67



**ESPIRALINA PEAD**  
PEAD SPIRAL HOSE  
GAINE DE PROTECTION PEAD SPIRALÉE

Ref.	∅	€
MANFL013	13X16	9,01
MANFL017	17x20	9,82
MANFL021	21x25	13,30
MANFL027	27X32	21,75
MANFL035	35X40	29,88
MANFL045	45X50	36,87



**ESPIRALINA PEAD ROJO**  
PEAD RED SPIRAL HOSE  
GAINE DE PROTECTION PEAD ROUGE SPIRALÉE

Ref.	∅	€
MANFL013R	13X16	9,01
MANFL017R	17X20	9,82
MANFL021R	21x25	13,30
MANFL027R	27X32	21,75
MANFL035R	35X40	29,88
MANFL045R	45X50	36,87



**ESPIRALINA PEAD AMARILLO**  
PEAD YELLOW SPIRAL HOSE  
GAINE DE PROTECTION PEAD JAUNE SPIRALÉE

Ref.	∅	€
MANFL013Y	13X16	9,01
MANFL017Y	17X20	9,80
MANFL021Y	21X25	13,30
MANFL027Y	27X32	21,75
MANFL035Y	35X40	29,88
MANFL045Y	45X50	36,87



**FUNDA DE PROTECCIÓN TEXTIL**  
TEXTILE SLEEV HOSES  
GAINE DE PROTECTION TEXTILE

Ref.	∅	€
MANPT35	20	2,41
MANPT40	22	2,41
MANPT45	25	3,26
MANPT50	28	3,26
MANPT55	32	3,81
MANPT60	35	4,34

Ref.	∅	€
MANFL058	58X63	45,33
MANFL069	69X75	84,06
MANFL082	82X90	104,23
MANFL100	100X110	107,49
MANFL116	116X125	116,56

Ref.	∅	€
MANFL058R	58X63	45,33
MANFL069R	69X75	84,06
MANFL082R	82X90	104,23
MANFL100R	100X110	107,49
MANFL116R	116X125	116,56

Ref.	∅	€
MANFL058Y	58X63	45,33
MANFL069Y	69X75	84,06
MANFL082Y	82X90	104,23
MANFL100Y	100X110	107,49
MANFL116Y	116X125	116,56

Ref.	∅	€
MANPT65	38	4,34
MANPT80	45	5,70
MANPT90	50	6,85
MANPT100	60	7,00
MANPT120	70	7,72
MANPT150	90	9,34

# VINCKE GRECA-10

## MANGUERA FLEXIBLE DE SUCCIÓN PARA ACEITE

### ¿QUÉ ES VINCKE GRECA-10?

La Vincke Greca-10, es una manguera corrugada, ultra flexible y resistente, ideal para transferencia de aceite en aplicaciones de baja presión.

### VENTAJAS COMPETITIVAS

- Alta flexibilidad para instalaciones con espacios reducidos
- Resistencia a aplastamientos y dobleces, asegurando un flujo constante
- Alternativa económica a mangueras moldeadas bajo pedido
- Fácil de instalar y manipular, ahorrando tiempo y esfuerzo
- Durabilidad superior frente a condiciones exigentes.

### APLICACIONES COMUNES

- Succión y retorno de aceite
- Transferencia de diésel, biodiésel (hasta B20), etanol y gasolina
- Equipos móviles y fuera de carretera
- Líneas de drenaje y llenado de combustible
- Transferencias industriales generales

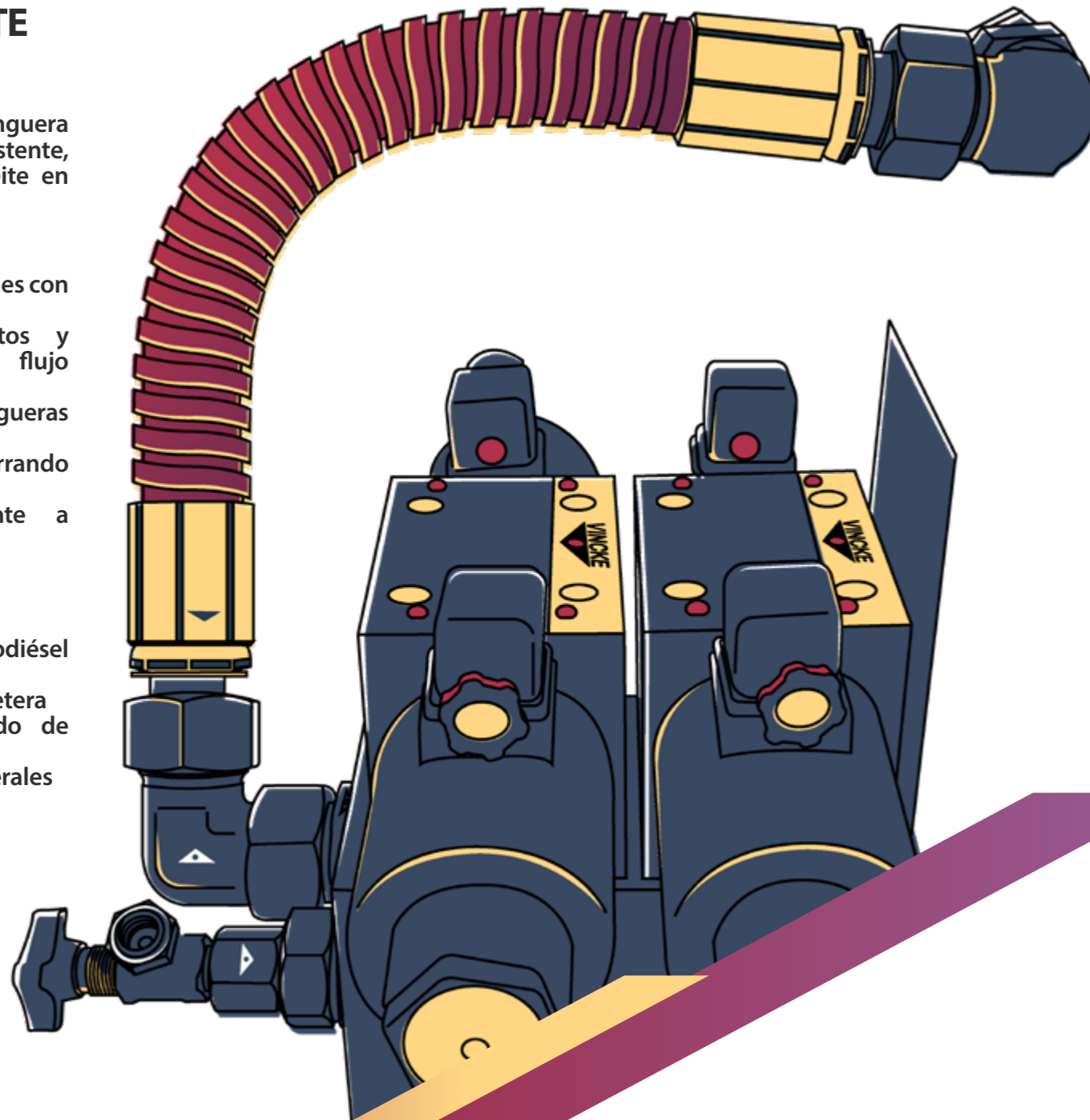

## FLEXIBLE OIL SUCTION HOSE

### WHAT IS VINCKE GRECA-10?

Vincke Greca-10 is a corrugated, ultra-flexible, and durable hose, ideal for low-pressure oil transfer applications.

### COMPETITIVE ADVANTAGES

- High flexibility for installations in tight spaces
- Crush and kink resistance ensures continuous flow
- Cost-effective and adaptable alternative to custom-molded hoses
- Easy to install and handle, saving time and effort
- Superior durability under demanding conditions

### COMMON APPLICATIONS

- Oil suction and return lines
- Transfer of diesel, biodiesel (up to B20), ethanol, and gasoline
- Mobile and off-road equipment
- Fuel fill and drain lines
- General industrial transfers

## TUYAU FLEXIBLE D'ASPIRATION POUR L'HUILE

### QU'EST-CE QUE VINCKE GRECA-10?

Vincke Greca-10 est un tuyau ondulé, ultra flexible et résistant, idéal pour le transfert d'huile dans des applications à basse pression.

### AVANTAGES CONCURRENTIELS

- Ultra-flexibilité pour les installations dans des espaces restreints
- Résistance à l'écrasement et au pliage, assurant un débit constant
- Alternative économique aux tuyaux moulés sur commande
- Facile à installer et à manipuler, économisant temps et efforts
- Durabilité supérieure dans des conditions exigeantes

### APPLICATIONS COURANTES

- Aspiration et retour d'huile
- Transfert de diesel, biodiesel (jusqu'à B20), éthanol et essence
- Équipements mobiles et tout-terrain
- Lignes de drainage et de remplissage de carburant
- Transferts industriels généraux



**FUNDA SILICON FIBERGLASS**  
SLEEVE SILICON FIBERGLASS  
GAINE SILICON FIBERGLASS

Ref.	Ø	€
MANFIRE010	10	18,63
MANFIRE015	15	25,63
MANFIRE020	20	36,59
MANFIRE025	25	42,06
MANFIRE029	29	68,31
MANFIRE032	32	51,36
MANFIRE035	35	57,88
MANFIRE041	41	54,09
MANFIRE050	51	102,69
MANFIRE060	60	207,00
MANFIRE076	76	362,44

**TAPONES PLÁSTICO**  
PLASTIC PLUG  
BOUCHONS PLASTIQUE

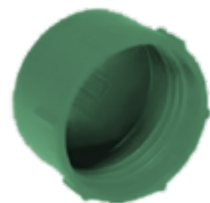

**HEMBRA BSPP**  
BSPP FEMALE  
FEMELLE BSPP

Ref.	Ø	€
RAC99010002	1/8	0,16
RAC99010004	1/4	0,16
RAC99010006	3/8	0,27
RAC99010008	1/2	0,34
RAC99010010	5/8	0,36
RAC99010012	3/4	0,41
RAC99010016	1"	1,17
RAC99010020	1" 1/4	0,72
RAC99010024	1" 1/2	0,84
RAC99010032	2"	1,25

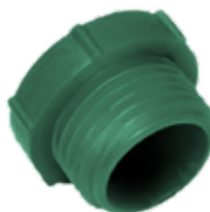

**MACHO BSPP**  
BSPP MALE  
MÂLE BSPP

Ref.	Ø	€
RAC99110002	1/8	0,29
RAC99110004	1/4	0,34
RAC99110006	3/8	0,36
RAC99110008	1/2	0,50
RAC99110012	3/4	0,60
RAC99110016	1"	0,81
RAC99110020	1" 1/4	1,48
RAC99110024	1" 1/2	1,71
RAC99110032	2"	2,08

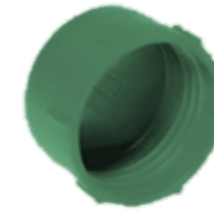

**HEMBRA JIC**  
JIC FEMALE  
FEMELLE JIC

Ref.	Ø	€
RAC99040004	7/16	0,16
RAC99040005	1/2	0,17
RAC99040006	9/16	0,26
RAC99040008	3/4	0,34
RAC99040010	7/8	0,44

Ref.	Ø	€
RAC99040012	1" 1/16	0,56
RAC99040016	1" 5/16	0,62
RAC99040020	1" 5/8	1,17
RAC99040024	1" 7/8	2,00
RAC99040032	2" 1/2	2,53

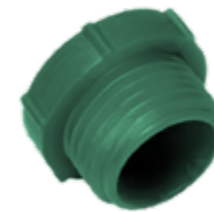

**MACHO JIC**  
JIC MALE  
MÂLE JIC

Ref.	Ø	€
RAC99440004	7/16	0,34
RAC99440005	1/2	0,34
RAC99440006	9/16	0,39
RAC99440008	3/4	0,82
RAC99440010	7/8	0,55

Ref.	Ø	€
RAC99440012	1" 1/16	0,72
RAC99440016	1" 5/16	0,95
RAC99440020	1" 5/8	1,94
RAC99440024	1" 7/8	1,94
RAC99440032	2" 1/2	2,98

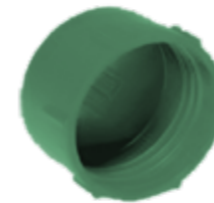

**HEMBRA MÉTRICA**  
METRIC FEMALE  
FEMELLE MÉTRIQUE

Ref.	Ø	€
RAC99060006	12x150	0,35
RAC99060008	14x150	0,49
RAC99060010	16x150	0,55
RAC99060012	18x150	0,35
RAC99060013	20x150	0,49
RAC99060014	22x150	0,41

Ref.	Ø	€
RAC99060016	24x150	0,67
RAC99060018	26x150	0,54
RAC99060020	30x200	0,62
RAC99060025	36x200	0,95
RAC99060030	42x200	1,21
RAC99060038	52x200	2,23

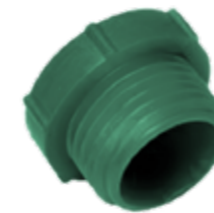

**MACHO MÉTRICO**  
METRIC MALE  
MÂLE MÉTRIQUE

Ref.	Ø	€
RAC99660006	12x150	0,50
RAC99660008	14x150	0,50
RAC99660010	16x150	0,50
RAC99660012	18x150	0,79
RAC99660013	20x150	0,55
RAC99660014	22x150	0,88
RAC99660016	24x150	0,71

Ref.	Ø	€
RAC99660018	26x150	0,72
RAC99660020	30x200	0,81
RAC99660025	36x200	1,17
RAC99660030	42x200	1,40
RAC99660035	45x200	1,65
RAC99660038	52x200	2,52

**CAPSULAS ECO**  
ECO CAPS  
CAPSULES ECO



Ref.	Ø	€
RACCP14L	14	0,28
RACCP16L	16	0,35
RACCP17L	17	0,25
RACCP19L	19	0,27
RACCP22L	22	0,30
RACCP24L	24	0,49
RACCP25L	25	0,45
RACCP27L	27	0,43
RACCP30L	30	0,59
RACCP32L	32	0,59
RACCP36L	36	0,75
RACCP41L	41	0,89
RACCP46L	46	1,45
RACCP50L	50	1,54
RACCP55L	55	2,04
RACCP60L	60	2,26
RACCP65L	65	2,99
RACCP70L	70	2,83
RACCP75L	75	3,21
RACCP80L	80	3,94

**CAPSULAS THERMO**  
THERMO CAPS  
CAPSULES THERMO



Ref.	Ø	€
RACCT2224	16 - 21	1,75
RACCT2527	18 - 23	1,75
RACCT3133	24 - 29	1,86
RACCT3840	30 - 36	1,86
RACCT4650	34 - 44	1,98
RACCT5860	49 - 56	1,98
RACCT6760	55 - 65	1,98
RACCT8060	64 - 78	2,09



**ABRAZADERA**  
CLAMPS  
COLLIERS

Ref.	Type	€
RACS0200	STOPFA Ø 14-15mm	8,68
RACS0201	STOPFA Ø 16-17mm	8,68
RACS0202	STOPFA Ø 18-19mm	8,68
RACS0203	STOPFA Ø 20-21mm	8,68
RACS0204	STOPFA Ø 21-22mm	8,68
RACS0205	STOPFA Ø 22-23mm	8,68
RACS0206	STOPFA Ø 24-25mm	9,02
RACS0207	STOPFA Ø 25-26mm	9,02
RACS0208	STOPFA Ø 27-28mm	9,02
RACS0209	STOPFA Ø 28-29mm	9,02
RACS0210	STOPFA Ø 30-31mm	9,02
RACS0211	STOPFA Ø 32-33mm	9,02
RACS0212	STOPFA Ø 34-35mm	9,02
RACS0213	STOPFA Ø 36-37mm	9,02
RACS0214	STOPFA Ø 38-39mm	10,07



**ESLINGA PARA ROSCAS DIN/BSP/JIC**  
SLING FOR DIN/BSP/JIC THREAD  
ÉLINGUES POUR FILETAGES DIN/BSP/JIC

Ref.	Ø	€
RACS0065	15	23,56
RACS0066	17	23,56
RACS0067	19	23,56
RACS0068	21	23,56
RACS0069	23	23,85
RACS0070	25	23,85
RACS0071	27	23,85
RACS0072	31	24,61
RACS0073	34	26,27
RACS0074	37	25,83
RACS0075	43	25,83
RACS0076	46	27,07
RACS0077	49	27,07
RACS0078	53	27,43
RACS0079	60	27,43

**ESLINGA PARA BRIDAS SAE**  
SLING FOR SAE FLANGE  
ÉLINGUES BRIDES SAE



Ref.	Ø	€
RACS0080	1/2	27,93
RACS0081	3/4-1"-1" 1/4 S3000- 3/4 S6000	27,96
RACS0082	1" 1/2-2" S3000-1" S6000	28,51
RACS0083	1" 1/4 S6000	28,70
RACS0084	1" 1/2 S6000	28,70
RACS0085	2" S6000	28,70

**FIJACIONES DE SEGURIDAD STOPFLEX**  
STOPFLEX RETENTION SYSTEM  
FIXATIONS DE SÉCURITÉ STOPFLEX

Ref.	Type	€
RACS0215	STOPFA Ø 40-41mm	10,13
RACS0216	STOPFA Ø 42-43mm	10,07
RACS0217	STOPFA Ø 44-45mm	10,53
RACS0218	STOPFA Ø 45-47mm	11,93
RACS0219	STOPFA Ø 48-50mm	12,14
RACS0220	STOPFA Ø 53-54mm	12,31
RACS0221	STOPFA Ø 54-56mm	12,50
RACS0222	STOPFA Ø 57-59mm	12,58
RACS0223	STOPFA Ø 60-62mm	12,66
RACS0224	STOPFA Ø 63-65mm	12,66
RACS0225	STOPFA Ø 66-68mm	13,88
RACS0226	STOPFA Ø 69-71mm	13,88
RACS0227	STOPFA Ø 72-74mm	13,88
RACS0228	STOPFA Ø 75-77mm	19,27

# FUNDA SILICON FIBERGLASS

La Silicon Fiberglass es una funda de protección térmica especialmente diseñada para resistir las altas temperaturas del compartimento del motor.

Es ideal para proteger mangueras, cables eléctricos, líneas de aceite y combustible.

Está fabricada con una manga trenzada de fibra de vidrio aislante, recubierta con caucho de silicona 100% con óxido de hierro, lo que le otorga una excelente resistencia térmica y durabilidad.

## CARACTERÍSTICAS PRINCIPALES:

- Soporta hasta 1650°C de calor ambiental y 560°C de calor directo continuo
- Compatible con el diámetro exterior de la manguera (ej: manguera de 10mm = funda de 10 mm)
- Flexible para adaptarse a curvas cerradas y facilitar la instalación y el desmontaje
- Resistente al agua, al aceite y a la suciedad del camino
- Incluye cinta térmica para sellar los extremos y evitar el desgaste
- Ideal para aplicaciones automotrices, industriales y de alto rendimiento

Una solución eficaz y duradera para protegerlos componentes críticos del calor extremo.

# SILICON FIBERGLASS SLEEVE

The Silicon Fiberglass is a thermal protection sleeve designed to withstand extreme under-hood temperatures.

It's ideal for protecting hoses, electrical wiring, and oil or fuel lines.

Made from braided fiberglass with a 100% ironoxide silicone rubber coating, it delivers excellent heat resistance and durability.

## KEY FEATURES

- Withstands up to 1650 °C ambient and 560°C direct continuous heat
- Inner diameter should match the hose (e.g.10 mm)
- Flexible for tight bends, easy to install and remove
- Resistant to water, oil, and road grime
- Includes fire tape to seal the sleeve ends
- Suitable for automotive, industrial, and high-performance use

# FUNDA SILICON FIBERGLASS

La Silicon Fiberglass est une gaine de protection thermique conçue pour résister aux températures élevées sous le capot.

Elle est parfaite pour protéger les tuyaux, les câbles électriques ainsi que les conduites d'huile et de carburant.

Elle est fabriquée en fibre de verre tressée isolante, avec un revêtement en caoutchouc de silicone 100% enrichi à l'oxyde de fer, offrant une excellente résistance thermique et une grande durabilité.

## CARACTÉRISTIQUES PRINCIPALES

- Résiste jusqu'à 1650°C en chaleur ambiante et 560°C en chaleur directe continue
- Choix du diamètre égal à celui du tuyau (ex: tuyau de 10 mm = gaine de 10 mm)
- Flexible, s'adapte aux courbes serrées et facilite l'installation et le retrait
- Résistante à l'eau, à l'huile et à la saleté de la route
- Livrée avec un ruban thermique pour sceller les extrémités
- Idéale pour les applications automobiles, industrielles ou de haute performance

Une protection fiable et durable contre les températures extrêmes pour vos composants essentiels.

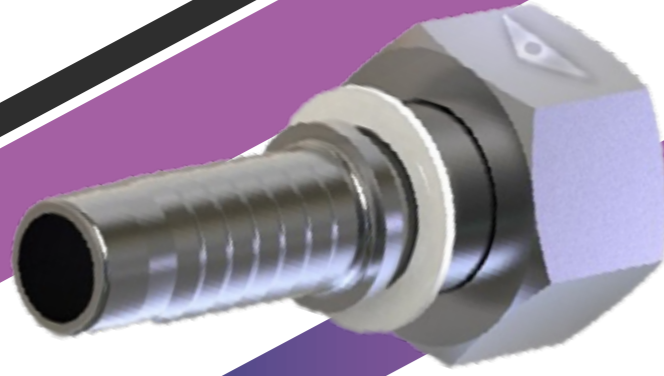

## CONEXIONES PRENSAR ALTA ALTÍSIMA PRESIÓN

### HIGH AND EXTREMELY HIGH CRIMPING FITTINGS CONNEXIONS A SERTIR HAUTE/TRES HAUTE PRESSION

En Vincke ofrecemos una gama completa de racores para mangueras hidráulicas, diseñados para aplicaciones de alta y altísima presión. Fabricados en acero al carbono o en acero inoxidable AISI 316L, todos nuestros racores son tratados térmicamente y protegidos con recubrimientos avanzados de zinc-cromo III o zinc-níquel, que ofrecen una alta resistencia a la corrosión.

Disponemos de soluciones para mangueras de 1 y 2 mallas, así como para 4 y 6 espirales, garantizando compatibilidad con los principales estándares del mercado.

Una ventaja clave del sistema Vincke es que no requiere pelado de la manguera, ni interno ni externo, lo que asegura un montaje más rápido, seguro y limpio, sin comprometer la fiabilidad. Sistema garantizado.

At Vincke, we offer a complete range of hydraulic hose fittings engineered for high and ultra-high pressure applications. Manufactured in carbon steel or AISI 316L stainless steel, all fittings undergo thermal treatment and are protected with advanced zinc-chromium III or zinc-nickel coatings, ensuring superior corrosion resistance. We provide fittings compatible with 1 and 2 wire braid hoses, as well as 4 and 6 spiral hose constructions, meeting the requirements of major industry standards.

A major advantage of the Vincke system is that it requires no hose skiving—neither internal nor external—ensuring faster, safer, and cleaner assembly without sacrificing performance. System guaranteed.

Chez Vincke, nous proposons une gamme complète de raccords hydrauliques conçus pour des applications à haute et très haute pression. Fabriqués en acier carbone ou en acier inoxydable AISI 316L, tous nos raccords subissent un traitement thermique et sont protégés par des revêtements avancés en zinc-chrome III ou zinc-nickel, garantissant une excellente résistance à la corrosion.

Nous proposons des solutions pour tuyaux à 1 ou 2 tresses, ainsi que pour tuyaux à 4 ou 6 spirales, conformes aux principaux standards du marché.

L'un des grands avantages du système Vincke est qu'il ne nécessite aucun dénudage du tuyau, ni intérieur ni extérieur, ce qui permet un assemblage plus rapide, plus propre et plus sûr, sans compromettre la fiabilité. Système garanti.

**01 CONEXIONES PRENSAR  
1SC 1SN 2SC 2SN 2SNK  
4SP 4SH Y TERMOPLÁSTICAS**  
CRIMPING FITTINGS  
1SC 1SN 2SC 2SN 2SNK 4SP 4SH  
AND THERMOPLASTICS  
CONNEXIONS A SERTIR  
1SC 1SN 2SC 2SN 2SNK  
4SP 4SH ET THERMOPLASTIQUE  
PÁGINA 50

**02 CONEXIONES PRENSAR 1SC 1SN 2SC  
2SNK 4SP 4SH Zn-Ni**  
CRIMPING FITTINGS 1SC 1SN 2SC 2SNK  
4SP 4SH Zn-Ni  
CONNEXIONS A SERTIR 1SC 1SN 2SC 2SNK  
4SP 4SH Zn-Ni  
PÁGINA 70

**03 CONEXIONES PRENSAR UNA PIEZA  
1SN-2SC-2SN-2SNK-4SP**  
CRIMPING FITTINGS ONE PIECE  
1SN-2SC-2SN-2SNK-4SP  
CONNEXIONS A SERTIR UNE PIÈCE  
1SN-2SC-2SN-2SNK-4SP  
PÁGINA 82

**04 CONEXIONES PRENSAR 4 Y 6  
ESPIRALES**  
CRIMPING FITTINGS 4 AND 6 SPIRAL  
CONNEXIONS A SERTIR 4 ET 6 TRESSSES  
PÁGINA 90

**05 CONEXIONES PRENSAR VIN-BLAST**  
CRIMPING FITTINGS VIN-BLAST  
CONNEXIONS A SERTIR VIN-BLAST  
PÁGINA 102

**06 CONEXIONES PRENSAR JACK HOSE 700  
BAR**  
CRIMPING FITTINGS JACK HOSE 700 BAR  
CONNEXIONS A SERTIR JACK HOSE 700 BAR  
PÁGINA 103

**07 CONEXIONES PRENSAR DE CONTROL  
DE PRESIÓN**  
CRIMPING FITTINGS PRESSURE  
CONTROL  
CONNEXIONS A SERTIR DE CÔNTROLE DE  
PRESSION  
PÁGINA 107

**08 CONEXIONES PRENSAR DE BAJA  
PRESIÓN**  
CRIMPING FITTINGS LOW PRESSURE  
CONNEXIONS A SERTIR BASSE PRESSION  
PÁGINA 111

**CONEXIONES PRENSAR 1SC 1SN 2SC 2SN 2SNK 4SP 4SH Y TERMOPLÁSTICAS**  
1SC 1SN 2SC 2SN 2SNK 4SP 4SH AND THERMOPLASTICS HOSE FITTINGS  
CONNEXIONS À SERTIR 1SC 1SN 2SC 2SN 2SNK 4SP 4SH ET THERMOPLASTIQUE

**CASQUILLOS**  
FERRULES  
JUPES



**CASQUILLO 1SC/1SN**  
FERRULE 1SC/1SN  
JUPE 1SC/1SN

Ref.		€
RAPR0040004	1/4	1,49
RAPR0040005	5/16	1,78
RAPR0040006	3/8	1,83
RAPR0040008	1/2	2,48
RAPR0040012	3/4	5,52
RAPR0040016	1"	8,26



**CASQUILLO 1SN 2SN 2SC 2SNK**  
1SN 2SN 2SC 2SNK FERRULE  
JUPE 1SN 2SN 2SC 2SNK

Ref.		€
RAPR00550004	1/4	1,59
RAPR00550005	5/16	2,03
RAPR00550006	3/8	2,16
RAPR00550008	1/2	2,80
RAPR00550010	5/8	3,74
RAPR00550012	3/4	4,87
RAPR00550016	1"	13,45
RAPR00550020	1" 1/4	26,85
RAPR00550024	1" 1/2	48,22
RAPR00550032	2"	66,18
RAPR00550040	2" 1/2	77,63
RAPR00550048	3"	89,01



**CASQUILLO 4SP - 4SS+ - 4SH NO PELADO EXTERNO**  
4SP - 4SS+ - 4SH FERRULE NOT OUTER SKIVE  
JUPE 4SP - 4SS+ - 4SH SANS DÉNUDAGE EXTÉRIEUR

Ref.		€
RAPR004N0006	3/8	4,60
RAPR004N0008	1/2	5,42
RAPR004N0010	5/8	6,34
RAPR004N0012	3/4	7,85
RAPR004N0016	1"	12,51



**CASQUILLO 4SH PELADO EXTERIOR**  
4SH FERRULE OUTER SKIVE  
JUPE 4SH DÉNUDAGE EXTÉRIEUR

Ref.		€
RAPR004S0020	1" 1/4	33,36
RAPR004S0024	1" 1/2	35,64
RAPR004S0032	2"	84,25



**CASQUILLO TERMOPLÁSTICA R7-R8-1 MALLA MET.-PTFE**  
FERRULE - THERMOPLASTIC R7-R8-1 WIRE-PTFE  
JUPE THERMOPLASTIQUE R7-R8-1 TRESSE-PTFE

Ref.		€
RAPR0080002	1/8	4,16
RAPR0080003	3/16	1,68
RAPR0080004	1/4	1,93
RAPR0080005	5/16	2,02
RAPR0080006	3/8	2,11
RAPR0080008	1/2	3,29
RAPR0080010	5/8	5,31
RAPR0080012	3/4	9,24
RAPR0080016	1"	16,42



**CASQUILLO TERMOPLÁSTICA 2 MALLAS MET.**  
2 WIRE THERMOPLASTIC FERRULE  
JUPE THERMOPLASTIQUE 2 TRESSE

Ref.		€
RAPR00880004	1/4	3,73
RAPR00880005	5/16	2,35
RAPR00880006	3/8	4,04
RAPR00880008	1/2	10,87
RAPR00880010	5/8	11,06
RAPR00880012	3/4	28,60
RAPR00880016	1"	10,96



**CASQUILLO TERMOPLÁSTICA MTKH**  
MTKH THERMOPLASTIC FERRULE  
JUPE THERMOPLASTIQUE MTKH

Ref.		€
RAPR00890004	1/4	5,48
RAPR00890006	3/8	8,05
RAPR00890008	1/2	16,09



**CASQUILLO PTFE CORRUGADO**  
FERRULE PTFE CONVOLUTED  
JUPE À SERTIR PTFE ONDULÉ

Ref.		€
RAPR0050006	3/8	3,28
RAPR0050008	1/2	3,41
RAPR0050010	5/8	3,88
RAPR0050012	3/4	4,09
RAPR0050016	1"	7,92
RAPR0050020	1" 1/4	14,25
RAPR0050024	1" 1/2	14,67
RAPR0050032	2"	16,50

**RACORES PRENSAR BSPP**  
BSPP HOSE FITTINGS  
BSPP RACCORD À SERTIR

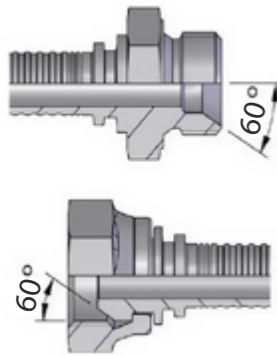

**BS5200 ISO 8434-6 / ISO 12151-6**

		(Nm)	Working Pressure (bar)
	1/8-28	15	420
	1/4-19	40	450
	3/8-19	45	400
	1/2-14	55	400
	5/8-14	65	350
	3/4-14	85	350
	1"-11	135	350
	1"1/4-11	175	240
	1"1/2-11	240	210
	2"-11	300	170

RECOMENDACIÓN  
RECOMMENDATION  
RECOMMENDATION

**HEMBRA GIRATORIA BSPP CONO 60°**

60° BSPP CONE SWIVEL FEMALE  
FEMELLE TOURNANTE BSPP CONE 60°



Ref.			€
RAPR10110202	1/8	1/8	10,35
RAPR10110203	1/8	3/16	4,75
RAPR10110204	1/8	1/4	3,93
RAPR10110403	1/4	3/16	5,39
RAPR10110404	1/4	1/4	2,15
RAPR10110405	1/4	5/16	4,26
RAPR10110406	1/4	3/8	2,29
RAPR10110604	3/8	1/4	2,85
RAPR10110605	3/8	5/16	2,89
RAPR10110606	3/8	3/8	2,94
RAPR10110608	3/8	1/2	4,97
RAPR10110804	1/2	1/4	3,88
RAPR10110805	1/2	5/16	3,88
RAPR10110806	1/2	3/8	3,71
RAPR10110808	1/2	1/2	3,72
RAPR10110810	1/2	5/8	5,90
RAPR10111008	5/8	1/2	5,90
RAPR10111010	5/8	5/8	5,64
RAPR10111208	3/4	1/2	7,25
RAPR10111210	3/4	5/8	5,92
RAPR10111212	3/4	3/4	6,37
RAPR10111612	1"	3/4	11,19
RAPR10111616	1"	1"	9,70
RAPR10112016	1" 1/4	1"	25,75
RAPR10112020	1" 1/4	1" 1/4	21,48
RAPR10112420	1" 1/2	1" 1/4	56,52
RAPR10112424	1" 1/2	1" 1/2	45,22
RAPR10113224	2"	1" 1/2	91,08
RAPR10113232	2"	2"	71,72
RAPR10114040	2" 1/2	2" 1/2	130,49
RAPR10114848	3"	3"	203,90

**HEMBRA GIRATORIA BSPP ASIENTO PLANO**

BSPP SWIVEL FEMALE FLAT SEAT  
FEMELLE TOURNANTE BSPP FOND PLAT



Ref.			€
RAPR10120404	1/4	1/4	5,13
RAPR10120604	3/8	1/4	12,81
RAPR10120606	3/8	3/8	6,14
RAPR10120806	1/2	3/8	8,17
RAPR10120808	1/2	1/2	6,95
RAPR10121212	3/4	3/4	10,17
RAPR10121616	1"	1"	23,19

**MACHO FIJO BSPP**

BSPP STUD MALE  
MÂLE FIXE BSPP



Ref.			€
RAPR10130203	1/8	3/16	8,13
RAPR10130204	1/8	1/4	5,17
RAPR10130403	1/4	3/16	5,87
RAPR10130404	1/4	1/4	2,82
RAPR10130405	1/4	5/16	4,64
RAPR10130406	1/4	3/8	6,51
RAPR10130604	3/8	1/4	3,25
RAPR10130605	3/8	5/16	3,64
RAPR10130606	3/8	3/8	3,10
RAPR10130608	3/8	1/2	4,90
RAPR10130804	1/2	1/4	7,92
RAPR10130805	1/2	5/16	5,84
RAPR10130806	1/2	3/8	4,56
RAPR10130808	1/2	1/2	4,32
RAPR10130810	1/2	5/8	11,29
RAPR10131010	5/8	5/8	10,02
RAPR10131208	3/4	1/2	14,72
RAPR10131210	3/4	5/8	10,33
RAPR10131212	3/4	3/4	8,41
RAPR10131612	1"	3/4	18,63
RAPR10131616	1"	1"	16,54
RAPR10132016	1" 1/4	1"	35,19
RAPR10132020	1" 1/4	1" 1/4	31,51
RAPR10132420	1" 1/2	1" 1/4	72,45
RAPR10132424	1" 1/2	1" 1/2	67,20
RAPR10133224	2"	1" 1/2	144,75
RAPR10133232	2"	2"	128,89

### HEMBRA GIRATORIA 90° BSPP

90° BSPP SWIVEL FEMALE  
FEMELLE TOURNANTE 90° BSPP



Ref.	Ø	L	€
RAPR10150203	1/8	3/16	9,94
RAPR10150403	1/4	3/16	9,55
RAPR10150404	1/4	1/4	3,94
RAPR10150604	3/8	1/4	4,82
RAPR10150605	3/8	5/16	5,27
RAPR10150606	3/8	3/8	4,69
RAPR10150608	3/8	1/2	19,97
RAPR10150804	1/2	1/4	7,04
RAPR10150805	1/2	5/16	6,17
RAPR10150806	1/2	3/8	6,04
RAPR10150808	1/2	1/2	6,10
RAPR10150810	1/2	5/8	18,11

### HEMBRA GIRATORIA 90° BSPP CORTO

90° BSPP SWIVEL FEMALE - SHORT  
FEMELLE TOURNANTE 90° BSPP COURT



Ref.	Ø	L	€
RAPR10150404CP	1/4	1/4	10,27
RAPR10150606CP	3/8	3/8	12,02
RAPR10150808CP	1/2	1/2	13,54
RAPR10151212CP	3/4	3/4	22,59

### HEMBRA GIRATORIA 45° BSPP

BSPP 45° SWIVEL FEMALE  
FEMELLE TOURNANTE 45° BSPP



Ref.	Ø	L	€
RAPR10160404	1/4	1/4	4,20
RAPR10160604	3/8	1/4	8,53
RAPR10160605	3/8	5/16	9,05
RAPR10160606	3/8	3/8	5,50
RAPR10160806	1/2	3/8	9,98
RAPR10160808	1/2	1/2	6,72
RAPR10161008	5/8	1/2	12,36
RAPR10161010	5/8	5/8	12,85
RAPR10161208	3/4	1/2	15,92

### MACHO BSPTF

BSPTF MALE  
MÂLE BSPTF



Ref.	Ø	L	€
RAPR10330605	3/8	5/16	8,97
RAPR10330606	3/8	3/8	4,10
RAPR10330806	1/2	3/8	6,19
RAPR10330808	1/2	1/2	5,57
RAPR10331212	3/4	3/4	8,55
RAPR10331612	1"	3/4	25,03
RAPR10331616	1"	1"	21,29

### MACHO NPTF

NPTF MALE  
MÂLE NPTF



Ref.	Ø	L	€
RAPR10230404	1/4	1/4	3,37
RAPR10230606	3/8	3/8	3,97
RAPR10230808	1/2	1/2	5,05
RAPR10231212	3/4	3/4	7,41
RAPR10231616	1"	1"	15,39
RAPR10232020	1" 1/4	1" 1/4	23,26
RAPR10232424	1" 1/2	1" 1/2	36,46
RAPR10233232	2"	2"	132,48

### ESFÉRICO BSPP - MÉTRICO

BSPP METRIC BANJO  
BANJO BSPP MÉTRIQUE



Ref.	Ø	L	€
RAPR10340404	1/4	1/4	4,39
RAPR10340406	1/4	3/8	7,27
RAPR10340604	3/8	1/4	7,05
RAPR10340605	3/8	5/16	5,34
RAPR10340606	3/8	3/8	5,39
RAPR10340806	1/2	3/8	12,22
RAPR10340808	1/2	1/2	12,26
RAPR10341004	10	1/4	5,07
RAPR10341204	12	1/4	5,54
RAPR10341208	3/4	1/2	18,64
RAPR10341212	3/4	3/4	18,01
RAPR10341404	14	1/4	6,97
RAPR10341405	14	5/16	5,92
RAPR10341406	14	3/8	6,43
RAPR10341604	16	1/4	10,59
RAPR10341605	16	5/16	8,34
RAPR10341606	16	3/8	6,81
RAPR10341612	1	3/4	62,13
RAPR10341616	1	1"	54,34
RAPR10341805	18	5/16	16,20
RAPR10341806	18	3/8	10,08
RAPR10341808	18	1/2	10,77
RAPR10342006	20	3/8	22,77
RAPR10342008	20	1/2	16,66
RAPR10342208	22	1/2	11,49
RAPR10342210	22	5/8	21,42

**RACOR PRENSAR SAE JIC**  
SAE JIC HOSE FITTING  
RACCORD À SERTIR SAE JIC

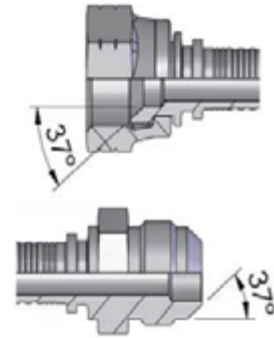

ISO 8434-2 / SAE J514 / ISO 12151-5

RECOMENDACIÓN  
RECOMMENDATION  
RECOMMENDATION

		(Nm)	Working Pressure (bar)
	7/16-20	20	350
	1/2-20	32	350
	9/16-18	40	350
	3/4-16	55	310
	7/8-14	70	240
	1" 1/16-12	105	240
	1" 5/16-12	160	210
	1" 7/8-12	170	170
	1" 7/8-12	200	140

**HEMBRA GIRATORIA SAE JIC**  
SAE JIC SWIVEL FEMALE  
FEMELLE TOURNANTE SAE JIC



Ref.			€
RAPR10410404	7/16	1/4	2,94
RAPR10410504	1/2	1/4	2,97
RAPR10410505	1/2	5/16	5,36
RAPR10410604	9/16	1/4	3,18
RAPR10410605	9/16	5/16	3,12
RAPR10410606	9/16	3/8	3,12
RAPR10410706	5/8	3/8	7,71
RAPR10410806	3/4	3/8	4,34
RAPR10410808	3/4	1/2	4,39
RAPR10411006	7/8	3/8	6,20
RAPR10411008	7/8	1/2	5,30
RAPR10411010	7/8	5/8	6,38
RAPR10411208	1" 1/16	1/2	8,28
RAPR10411210	1" 1/16	5/8	7,04
RAPR10411212	1" 1/16	3/4	7,45
RAPR10411412	1" 3/16	3/4	18,84
RAPR10411612	1" 5/16	3/4	13,38
RAPR10411616	1" 5/16	1"	13,11
RAPR10412016	1" 5/8	1"	28,98
RAPR10412020	1" 5/8	1" 1/4	24,59
RAPR10412424	1" 7/8	1" 1/2	57,10
RAPR10413232	2" 1/2	2"	91,08

**MACHO FIJO SAE JIC**  
SAE JIC STUD MALE  
MÂLE FIXE SAE JIC



Ref.			€
RAPR10430404	7/16	1/4	3,22
RAPR10430504	1/2	1/4	4,24
RAPR10430604	9/16	1/4	4,06
RAPR10430605	9/16	5/16	4,08
RAPR10430606	9/16	3/8	2,83
RAPR10430806	3/4	3/8	3,60
RAPR10430808	3/4	1/2	4,01
RAPR10431006	7/8	3/8	6,00
RAPR10431008	7/8	1/2	5,41
RAPR10431010	7/8	5/8	6,47

Ref.			€
RAPR10431208	1" 1/16	1/2	9,93
RAPR10431210	1" 1/16	5/8	7,70
RAPR10431212	1" 1/16	3/4	12,51
RAPR10431412	1" 3/16	3/4	13,80
RAPR10431612	1" 5/16	3/4	12,77
RAPR10431616	1" 5/16	1"	14,95
RAPR10432020	1" 5/8	1" 1/4	38,08
RAPR10432424	1" 7/8	1" 1/2	54,03
RAPR10433232	2" 1/2	2"	89,90

**HEMBRA GIRATORIA 90° SAE JIC**  
90° SAE JIC SWIVEL FEMALE  
FEMELLE TOURNANTE 90° SAE JIC



Ref.			€
RAPR10450404	7/16	1/4	5,44
RAPR10450504	1/2	1/4	6,05
RAPR10450604	9/16	1/4	5,98
RAPR10450605	9/16	5/16	6,17
RAPR10450606	9/16	3/8	6,75
RAPR10450806	3/4	3/8	6,77
RAPR10450808	3/4	1/2	12,20
RAPR10451006	7/8	3/8	11,17
RAPR10451008	7/8	1/8	10,96
RAPR10451010	7/8	5/8	13,83

Ref.			€
RAPR10451208	1" 1/16	1/2	16,56
RAPR10451210	1" 1/16	5/8	16,74
RAPR10451212	1" 1/16	3/4	14,63
RAPR10451412	1" 3/16	3/4	37,68
RAPR10451612	1" 5/16	3/4	38,26
RAPR10451616	1" 5/16	1"	23,09
RAPR10452020	1" 5/8	1" 1/4	60,03
RAPR10452424	1" 7/8	1" 1/2	76,59
RAPR10453232	2" 1/2	2"	161,46

**HEMBRA GIRATORIA 45° SAE JIC**  
45° SAE JIC SWIVEL FEMALE  
FEMELLE TOURNANTE 45° SAE JIC



Ref.			€
RAPR10460404	7/16	1/4	6,92
RAPR10460504	1/2	1/4	7,10
RAPR10460604	9/16	1/4	6,32
RAPR10460605	9/16	5/16	8,34
RAPR10460606	9/16	3/8	6,33
RAPR10460806	3/4	3/8	7,60
RAPR10460808	3/4	1/2	9,83
RAPR10461006	7/8	3/8	10,62
RAPR10461008	7/8	1/2	9,30

Ref.			€
RAPR10461010	7/8	5/8	14,59
RAPR10461208	1" 1/16	1/2	23,87
RAPR10461210	1" 1/16	5/8	16,37
RAPR10461212	1" 1/16	3/4	18,94
RAPR10461612	1" 5/16	3/4	34,71
RAPR10461616	1" 5/16	1"	31,94
RAPR10462016	1" 5/8	1"	78,35
RAPR10462020	1" 5/8	1" 1/4	66,24
RAPR10462424	1" 7/8	1" 1/2	147,30

**RACOR PRENSAR MÉTRICO**  
METRIC HOSE FITTING  
RACCORD À SERTIR MÉTRIQUE

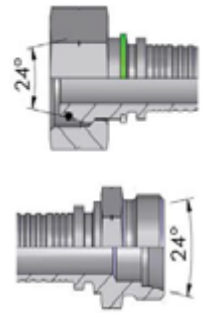

ISO 8434-1 / DIN 3865 / ISO 12151-2

RECOMENDACIÓN  
RECOMMENDATION  
RECOMMENDATION

		(Nm)	Working Pressure (bar)
	12x1,5	20	250
	14x1,5	25	250
	16x1,5	35	250
	18x1,5	40	250
	22x1,5	60	250
	26x1,5	80	160
	30x2	110	160
	36x2	150	100
	45x2	225	100
	52x2	230	100

**RACOR PRENSAR MÉTRICO SERIE LIGERA**  
METRIC HOSE FITTING L SERIES  
RACCORD À SERTIR MÉTRIQUE SÉRIE LÉGÈRE



**HEMBRA GIRATORIA MÉTRICA SERIE LIGERA**  
METRIC SWIVEL FEMALE LIGHT SERIES  
FEMELLE TOURNANTE MÉTRIQUE SÉRIE LÉGÈRE

Ref.	Ø			€
RAPR10811204	6	12x150	1/4	7,15
RAPR10811404	8	14x150	1/4	2,76
RAPR10811405	8	14x150	5/16	4,58
RAPR10811604	10	16x150	1/4	3,47
RAPR10811605	10	16x150	5/16	3,67
RAPR10811606	10	16x150	3/8	6,86
RAPR10811804	12	18x150	1/4	4,40
RAPR10811805	12	18x150	5/16	5,34
RAPR10811806	12	18x150	3/8	3,10
RAPR10811808	12	18x150	1/2	5,29
RAPR10812206	15	22x150	3/8	6,38
RAPR10812208	15	22x150	1/2	4,35
RAPR10812608	18	26x150	1/2	7,45
RAPR10812610	18	26x150	5/8	6,43
RAPR10812612	18	26x150	3/4	9,73
RAPR10813010	22	30x200	5/8	11,39
RAPR10813012	22	30x200	3/4	9,36
RAPR10813616	28	36x200	1"	16,37
RAPR10814520	35	45x200	1" 1/4	25,57
RAPR10815224	42	52x200	1" 1/2	48,34



**MACHO FIJO MÉTRICO SERIE LIGERA**  
METRIC STUD MALE LIGHT SERIES  
MÂLE FIXE MÉTRIQUE SÉRIE LÉGÈRE

Ref.	Ø			€
RAPR10631204	6	12x150	1/4	3,51
RAPR10631404	8	14x150	1/4	2,69
RAPR10631604	10	16x150	1/4	4,35
RAPR10631605	10	16x150	5/16	3,56
RAPR10631804	12	18x150	1/4	3,94
RAPR10631606	10	16x150	3/8	5,32
RAPR10631805	12	18x150	5/16	5,32
RAPR10631806	12	18x150	3/8	3,17
RAPR10632206	15	22x150	3/8	6,52
RAPR10632208	15	22x150	1/2	4,69
RAPR10632608	18	26x150	1/2	9,55
RAPR10632610	18	26x150	5/8	9,68
RAPR10633012	22	30x200	3/4	10,63
RAPR10633616	28	36x200	1"	17,57
RAPR10634520	35	45x200	1" 1/4	29,89
RAPR10635224	42	52x200	1" 1/2	44,45

**HEMBRA GIRATORIA 90° MÉTRICA SERIE LIGERA**  
90° METRIC SWIVEL FEMALE LIGHT SERIES  
FEMELLE TOURNANTE 90° MÉTRIQUE SÉRIE LÉGÈRE



Ref.	Ø			€
RAPR10851204	6	12x150	1/4	18,29
RAPR10851404	8	14x150	1/4	5,45
RAPR10851604	10	16x150	1/4	5,60
RAPR10851605	10	16x150	5/16	7,40
RAPR10851606	10	16x150	3/8	10,08
RAPR10851804	12	18x150	1/4	7,98
RAPR10851805	12	18x150	5/16	10,08
RAPR10851806	12	18x150	3/8	5,96
RAPR10852206	15	22x150	3/8	8,56
RAPR10852208	15	22x150	1/2	8,80
RAPR10852610	18	26x150	5/8	12,57
RAPR10852612	18	26x150	3/4	31,42
RAPR10853012	22	30x200	3/4	16,45
RAPR10853616	28	36x200	1"	34,27
RAPR10854520	35	45x200	1" 1/4	63,04
RAPR10855224	42	52x200	1" 1/2	119,14

**HEMBRA GIRATORIA 45° MÉTRICA SERIE LIGERA**  
45° METRIC SWIVEL FEMALE LIGHT SERIES  
FEMELLE TOURNANTE 45° MÉTRIQUE SÉRIE LÉGÈRE



Ref.	Ø			€
RAPR10861204	6	12x150	1/4	9,24
RAPR10861404	8	14x150	1/4	6,03
RAPR10861604	10	16x150	1/4	8,44
RAPR10861605	10	16x150	5/16	7,76
RAPR10861606	10	16x150	3/8	13,09
RAPR10861804	12	18x150	1/4	10,18
RAPR10861805	12	18x150	5/16	13,09
RAPR10861806	12	18x150	3/8	7,85
RAPR10862208	15	22x150	1/2	10,19
RAPR10862610	18	26x150	5/8	15,62
RAPR10863012	22	30x200	3/4	21,52
RAPR10863616	28	36x200	1"	31,35
RAPR10864520	35	45x200	1" 1/4	64,66
RAPR10865224	42	52x200	1" 1/2	152,97

**RACOR MÉTRICO SERIE PESADA**  
HEAVY SERIES METRIC FITTING  
RACCORD À SERTIR SÉRIE LOURDE

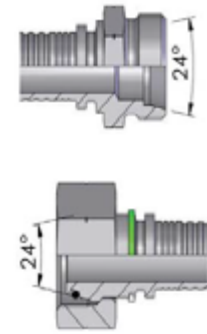

ISO 8434-1 / DIN 3865 / ISO 12151-2

RECOMENDACIÓN  
RECOMMENDATION  
RECOMMENDATION

		(Nm)	Working Pressure (bar)
	14x1,5	30	630
	16x1,5	35	630
	18x1,5	50	630
	20x1,5	60	630
	22x1,5	70	630
	24x1,5	80	400
	30x2	130	400
	36x2	190	400
	42x2	260	250
	52x2	270	250



**HEMBRA GIRATORIA MÉTRICA SERIE PESADA**  
METRIC SWIVEL FEMALE HEAVY SERIES  
FEMELLE TOURNANTE MÉTRIQUE SÉRIE LOURDE



Ref.	Ø			€
RAPR10911404	6	14x150	1/4	10,41
RAPR10911604	8	16x150	1/4	3,25
RAPR10911804	10	18x150	1/4	4,47
RAPR10911806	10	18x150	3/8	7,51
RAPR10912005	12	20x150	5/16	5,65
RAPR10912006	12	20x150	3/8	4,48
RAPR10912206	14	22x150	3/8	6,71
RAPR10912208	14	22x150	1/2	9,73
RAPR10912408	16	24x150	1/2	5,65
RAPR10913010	20	30x200	5/8	8,90
RAPR10913012	20	30x200	3/4	10,95
RAPR10913612	25	36x200	3/4	16,99
RAPR10913616	25	36x200	1"	23,92
RAPR10914216	30	42x200	1"	22,12
RAPR10915220	38	52x200	1" 1/4	49,34



**MACHO FIJO MÉTRICO SERIE PESADA**  
METRIC STUD MALE HEAVY SERIES  
MÂLE FIXE MÉTRIQUE SÉRIE LOURDE

Ref.	Ø			€
RAPR10731404	6	14x150	1/4	5,45
RAPR10731604	8	16x150	1/4	5,26
RAPR10731804	10	18x150	1/4	5,35
RAPR10731805	10	18x150	5/16	6,43
RAPR10731806	10	18x150	3/8	6,15
RAPR10732005	12	20x150	5/16	6,92
RAPR10732006	12	20x150	3/8	5,52
RAPR10732206	14	22x150	3/8	5,19
RAPR10732208	14	22x150	1/2	5,58
RAPR10732408	16	24x150	1/2	5,17
RAPR10733010	20	30x200	5/8	9,65
RAPR10733012	20	30x200	3/4	8,62
RAPR10733612	25	36x200	3/4	13,52
RAPR10733616	25	36x200	1"	19,62
RAPR10734216	30	42x200	1"	23,96
RAPR10735220	38	52x200	1" 1/4	38,26

**HEMBRA GIRATORIA 90° MÉTRICA SERIE PESADA**  
90° METRIC SWIVEL FEMALE HEAVY SERIES  
FEMELLE TOURNANTE 90° MÉTRIQUE SÉRIE LOURDE

Ref.	Ø			€
RAPR10951404	6	14x150	1/4	6,77
RAPR10951604	8	16x150	1/4	7,16
RAPR10951804	10	18x150	1/4	7,02
RAPR10952005	12	20x150	5/16	9,95
RAPR10952006	12	20x150	3/8	8,96
RAPR10952206	14	22x150	3/8	12,53
RAPR10952208	14	22x150	1/2	19,10
RAPR10952408	16	24x150	1/2	9,55
RAPR10953010	20	30x200	5/8	16,16
RAPR10953012	20	30x200	3/4	25,17
RAPR10953612	25	36x200	3/4	31,24
RAPR10953616	25	36x200	1"	51,52
RAPR10954216	30	42x200	1"	48,58
RAPR10955220	38	52x200	1" 1/4	79,16

**HEMBRA GIRATORIA 45° MÉTRICA SERIE PESADA**  
45° METRIC SWIVEL FEMALE HEAVY SERIES  
FEMELLE TOURNANTE 45° MÉTRIQUE SÉRIE LOURDE

Ref.	Ø			€
RAPR10961404	6	14x150	1/4	13,62
RAPR10961604	8	16x150	1/4	9,33
RAPR10961804	10	18x150	1/4	9,15
RAPR10961806	12	18x150	3/8	19,10
RAPR10962005	12	20x150	5/16	10,85
RAPR10962006	12	20x150	3/8	9,94
RAPR10962206	14	22x150	3/8	13,09
RAPR10962208	14	22x150	1/2	19,10
RAPR10962408	16	24x150	1/2	11,29
RAPR10963010	20	30x200	5/8	19,05
RAPR10963612	25	36x200	3/4	31,99
RAPR10963616	25	36x200	1"	54,09
RAPR10964216	30	42x200	1"	44,85
RAPR10965220	38	52x200	1" 1/4	91,60



**RACOR MÉTRICO SERIE FRANCESA**  
METRIC SERIES FRENCH FITTING  
RACCOR À SERTIR MÉTRIQUE SÉRIE GAZ



**HEMBRA GIRATORIA MÉTRICA SERIE FRANCESA**  
METRIC SWIVEL FEMALE FRENCH SERIES  
FEMELLE TOURNANTE MÉTRIQUE SÉRIE FRANÇAISE

Ref.	Ø	🌀	📏	€
RAPR11012004	13	20x150	1/4	12,72
RAPR11012005	13	20x150	5/16	4,73
RAPR11012006	13	20x150	3/8	5,34
RAPR11012408	17	24x150	1/2	16,33
RAPR11013010	21	30x150	5/8	40,87
RAPR11013012	21	30x150	3/4	51,86
RAPR11013612	27	36x150	3/4	43,78

**MACHO FIJO MÉTRICO SERIE FRANCESA**  
METRIC STUD MALE FRENCH SERIES  
MÂLE FIXE MÉTRIQUE SÉRIE FRANÇAISE



Ref.	Ø	🌀	📏	€
RAPR11032005	13	20x150	5/16	36,18
RAPR11032006	13	20x150	3/8	36,48
RAPR11032408	17	24x150	1/2	39,11
RAPR11033010	21	30x150	5/8	44,37
RAPR11033012	21	30x150	3/4	38,53
RAPR11033612	27	36x150	3/4	36,04
RAPR11034516	33	45x150	1"	52,55

**HEMBRA GIRATORIA 90° MÉTRICA SERIE FRANCESA**  
90° METRIC SWIVEL FEMALE FRENCH SERIES  
FEMELLE TOURNANTE 90° MÉTRIQUE SÉRIE FRANÇAISE



Ref.	Ø	🌀	📏	€
RAPR11052005	13	20x150	5/16	10,51
RAPR11052006	13	20x150	3/8	13,73
RAPR11052408	17	24x150	1/2	21,32
RAPR11053010	21	30x150	5/8	56,98
RAPR11053012	21	30x150	3/4	47,54
RAPR11053612	27	36x150	3/4	77,77

**ESPIGA LISA RECTA**  
STRAIGHT STANDPIPE  
EMBOUT LISSE DROIT



Ref.	Ø	📏	€
RAPR10540604	6	1/4	2,84
RAPR10540804	8	1/4	3,24
RAPR10541004	10	1/4	2,48
RAPR10541005	10	5/16	2,64
RAPR10541006	10	3/8	4,89
RAPR10541204	12	1/4	3,61
RAPR10541205	12	5/16	3,35
RAPR10541206	12	3/8	2,59
RAPR10541406	14	3/8	4,35
RAPR10541408	14	1/2	5,35
RAPR10541508	15	1/2	3,51
RAPR10541608	16	1/2	4,47

Ref.	Ø	📏	€
RAPR10541808	18	1/2	6,03
RAPR10541810	18	5/8	5,30
RAPR10542012	20	3/4	7,31
RAPR10542212	22	3/4	6,86
RAPR10542512	25	3/4	8,28
RAPR10542516	25	1"	13,54
RAPR10542816	28	1"	20,70
RAPR10543016	30	1"	14,25
RAPR10543520	35	1" 1/4	20,16
RAPR10543820	38	1" 1/4	23,48
RAPR10544224	42	1" 1/2	34,82

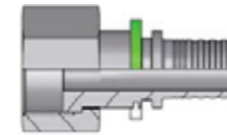
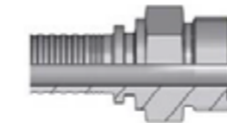

**RECOMENDACIÓN**  
RECOMMENDATION  
RECOMMENDATION

**RACOR PRENSAR ORFS**  
ORFS HOSE FITTING  
RACCOR À SERTIR ORFS

ISO 8434-3 / SAE J1453 9 ISO 12151-1

🌀	📏 (Nm)	💡 Working Pressure (bar)
9/16-18	40	450
11/16-16	70	450
13/16-16	80	420
1"-14	100	420
1"3/16-12	130	420
1"7/16-12	170	420
1"11/16-12	200	350
2"-12	260	275

**HEMBRA GIRATORIA ORFS**  
ORFS SWIVEL FEMALE  
FEMELLE TOURNANTE ORFS

Ref.	🌀	📏	€
RAPR11110404	9/16	1/4	2,81
RAPR11110604	11/16	1/4	2,82
RAPR11110605	11/16	5/16	2,89
RAPR11110606	11/16	3/8	2,83
RAPR11110806	13/16	3/8	4,14
RAPR11110808	13/16	1/2	3,73
RAPR11111008	1"	1/2	7,12
RAPR11111010	1"	5/8	7,12
RAPR11111210	1" 3/16	5/8	9,65
RAPR11111212	1" 3/16	3/4	9,65
RAPR11111612	1" 7/16	3/4	18,90
RAPR11111616	1" 7/16	1"	18,56
RAPR11112020	1" 11/16	1" 1/4	33,91
RAPR11112424	2"	1" 1/2	79,08

**MACHO FIJO ORFS**  
ORFS STUD MALE  
MÂLE FIXE ORFS

Ref.	🌀	📏	€
RAPR11130404	9/16	1/4	5,02
RAPR11130604	11/16	1/4	8,38
RAPR11130606	11/16	3/8	2,97
RAPR11130806	13/16	3/8	4,86
RAPR11130808	13/16	1/2	4,53
RAPR11131008	1"	1/2	7,17
RAPR11131010	1"	5/8	10,23
RAPR11131210	1" 3/16	5/8	11,37
RAPR11131212	1" 3/16	3/4	20,88
RAPR11131612	1" 7/16	3/4	20,48
RAPR11131616	1" 7/16	1"	38,23



**HEMBRA GIRATORIA 90° ORFS**  
90° ORFS SWIVEL FEMALE  
FEMELLE TOURNANTE 90° ORFS

Ref.			€
RAPR11150404	9/16	1/4	5,01
RAPR11150604	11/16	1/4	8,72
RAPR11150606	11/16	3/8	4,19
RAPR11150806	13/16	3/8	5,45
RAPR11150808	13/16	1/2	5,36
RAPR11151008	1"	1/2	9,35
RAPR11151010	1"	5/8	17,76
RAPR11151210	1" 3/16	5/8	13,27
RAPR11151212	1" 3/16	3/4	13,99
RAPR11151616	1" 7/16	1"	19,68
RAPR11152020	1" 11/16	1" 1/4	89,05
RAPR11152424	2"	1" 1/2	127,34



**HEMBRA GIRATORIA 45° ORFS**  
45° ORFS SWIVEL FEMALE  
FEMELLE TOURNANTE 45° ORFS

Ref.			€
RAPR11160404	9/16	1/4	3,59
RAPR11160604	11/16	1/4	3,64
RAPR11160606	11/16	3/8	5,32
RAPR11160806	13/16	3/8	6,65
RAPR11160808	13/16	1/2	5,84
RAPR11161008	1"	1/2	18,86
RAPR11161010	1"	5/8	9,67
RAPR11161210	1" 3/16	5/8	27,81
RAPR11161212	1" 3/16	3/4	15,31
RAPR11161616	1" 7/16	1"	22,90
RAPR11162020	1" 11/16	1" 1/4	97,80



**HEMBRA GIRATORIA JIS**  
JIS SWIVEL FEMALE  
FEMELLE TOURNANTE JIS

Ref.			€
RAPR111510404	1/4	1/4	8,87
RAPR111510606	3/8	3/8	10,07
RAPR111510808	1/2	1/2	16,32
RAPR111511212	3/4	3/4	20,14
RAPR111511616	1"	1"	28,67



**BRIDA RECTA S3000 PSI**  
S3000 PSI STRAIGHT FLANGE  
BRIDE DROITE S3000 PSI

Ref.	Ø			€
RAPR11340808	30,2	1/2	1/2	18,68
RAPR11341208	38,1	3/4	1/2	29,36
RAPR11341212	38,1	3/4	3/4	20,79
RAPR11341612	44,5	1"	3/4	28,24
RAPR11341616	44,5	1"	1"	28,28



**BRIDA 90° S3000 PSI**  
90° S3000 PSI FLANGE  
BRIDE 90° S3000 PSI

Ref.	Ø			€
RAPR11350808	30,2	1/2	1/2	28,94
RAPR11351208	38,1	3/4	1/2	42,44
RAPR11351212	38,1	3/4	3/4	34,51
RAPR11351612	44,5	1"	3/4	41,97
RAPR11351616	44,5	1"	1"	42,13



**BRIDA 45° S3000 PSI**  
45° S3000 PSI FLANGE  
BRIDE 45° S3000 PSI

Ref.	Ø			€
RAPR11360808	30,2	1/2	1/2	30,54
RAPR11361208	38,1	3/4	1/2	42,78
RAPR11361212	38,1	3/4	3/4	39,65
RAPR11361612	44,5	1"	3/4	39,01
RAPR11361616	44,5	1"	1"	49,58



**BRIDA RECTA S6000 PSI**  
S6000 PSI STRAIGHT FLANGE  
BRIDE DROITE S6000 PSI

Ref.	Ø			€
RAPR11440808	31,8	1/2	1/2	33,32
RAPR11441208	41,3	3/4	1/2	43,13
RAPR11441212	41,3	3/4	3/4	31,95
RAPR11441612	47,6	1"	3/4	46,74
RAPR11441616	47,6	1"	1"	36,06

**RACOR PRENSAR BRIDA SAE ISO 6162-1/2**  
ISO 6162-1/2 SAE FLANGE HOSE FITTING  
RACCORD À SERTIR BRIDE SAE ISO 6162-1/2

Ref.	Ø			€
RAPR11342016	50,8	1" 1/4	1"	55,79
RAPR11342020	50,8	1" 1/4	1" 1/4	42,62
RAPR11342420	60,3	1" 1/2	1" 1/4	64,58
RAPR11342424	60,3	1" 1/2	1" 1/2	68,43
RAPR11343232	71,4	2"	2"	120,79

Ref.	Ø			€
RAPR11352016	50,8	1" 1/4	1"	60,04
RAPR11352020	50,8	1" 1/4	1" 1/4	60,88
RAPR11352420	60,3	1" 1/2	1" 1/4	101,47
RAPR11352424	60,3	1" 1/2	1" 1/2	106,57
RAPR11353232	71,4	2"	2"	213,62

Ref.	Ø			€
RAPR11362016	50,8	1" 1/4	1"	58,71
RAPR11362020	50,8	1" 1/4	1" 1/4	52,42
RAPR11362420	60,3	1" 1/2	1" 1/4	97,51
RAPR11362424	60,3	1" 1/2	1" 1/2	105,60
RAPR11363232	71,4	2"	2"	213,62

Ref.	Ø			€
RAPR11442016	54	1" 1/4	1"	65,19
RAPR11442020	54	1" 1/4	1" 1/4	46,64
RAPR11442420	63,5	1" 1/2	1" 1/4	99,97
RAPR11442424	63,5	1" 1/2	1" 1/2	82,42



**BRIDA 90° S6000 PSI**  
90° S6000 PSI FLANGE  
BRIDE 90° S6000 PSI

TRef.	∅			€
RAPR11450808	31,8	1/2	1/2	32,24
RAPR11451208	41,3	3/4	1/2	62,02
RAPR11451212	41,3	3/4	3/4	41,57
RAPR11451612	47,6	1"	3/4	55,76
RAPR11451616	47,6	1"	1"	50,41
RAPR11452016	54	1" 1/4	1"	83,12
RAPR11452020	54	1" 1/4	1" 1/4	78,29
RAPR11452420	63,5	1" 1/2	1" 1/4	107,08
RAPR11452424	63,5	1" 1/2	1" 1/2	190,56



**BRIDA 45° S6000 PSI**  
45° S6000 PSI FLANGE  
BRIDE 45° S6000 PSI

Ref.	∅			€
RAPR11460808	31,8	1/2	1/2	31,35
RAPR11461208	41,3	3/4	1/2	57,15
RAPR11461212	41,3	3/4	3/4	43,48
RAPR11461612	47,6	1"	3/4	71,00
RAPR11461616	47,6	1"	1"	53,82
RAPR11462016	54	1" 1/4	1"	78,31
RAPR11462020	54	1" 1/4	1" 1/4	105,76
RAPR11462420	63,5	1" 1/2	1" 1/4	106,61
RAPR11462424	63,5	1" 1/2	1" 1/2	180,56



**UNIÓN MANGUERA**  
UNION TUYAU  
RAC.A SERTIR TUYAU

Ref.		€
RAPR1UNION04	1/4	4,20
RAPR1UNION05	5/16	4,44
RAPR1UNION06	3/8	4,79
RAPR1UNION08	1/2	6,77
RAPR1UNION10	5/8	10,06
RAPR1UNION12	3/4	15,04
RAPR1UNION16	1"	19,44

**RACORES PARA HIDROLAVADORA**  
HYDRO-WASH FITTING  
RACCORD HYDRONETTOYAGE



**HEMBRE GIRATORIA M.22x150 HIDROLAVADORA**  
SWIVEL FEMALE M22x150 HYDRO-WASH  
FEMELLE TOURNANTE M22\*150 HYDRONETTOYAGE

Ref.			€
RAPR1252204P	22x150	1/4	9,24
RAPR1252205P	22x150	5/16	8,18
RAPR1252206P	22x150	3/8	9,41

## ENCUENTRA NUESTROS PRODUCTOS AQUÍ

FIND OUR PRODUCTS HERE  
TROUVEZ NOS PRODUITS ICI



EN NUESTRA PÁGINA WEB PODRÁS ENCONTRAR  
TODA NUESTRA GAMA DE CATÁLOGOS

ON OUR WEBSITE YOU CAN FIND OUR FULL RANGE OF  
CATALOGUES

SUR NOTRE SITE WEB, VOUS POUVEZ TROUVER NOTRE  
GAMME COMPLÈTE DE CATALOGUES

[www.vinckehydraulics.com](http://www.vinckehydraulics.com)

# RACORES-RAPZ

## PRESENTAMOS LOS NUEVOS RACORES PRENSADOS VINCKE CON TRATAMIENTO EN ZINC-NÍQUEL

En Vincke seguimos innovando para ofrecer soluciones más duraderas, eficientes y seguras. Nuestra última incorporación a la gama de productos son los racores de prensar con recubrimiento de Zinc-Níquel, diseñados para elevar el rendimiento y la fiabilidad de sus instalaciones hidráulicas.

El recubrimiento de Zn-Ni proporciona una resistencia excepcional, soportando hasta 720 horas sin corrosión blanca y 1,500 horas sin corrosión roja en pruebas de niebla salina.

Este revestimiento de zinc-níquel, junto con la capa de sellado, ofrece un espesor uniforme, un coeficiente de fricción estable y una excelente resistencia al desgaste.

La fase de pasivación y sellado posterior permite alcanzar un rendimiento técnico y una resistencia a la corrosión que superan ampliamente los estándares habituales.

De acuerdo con la norma UNI ISO 9227.

**COMPATIBLES CON MANGUERAS DE 1, 2 Y 4 MALLAS**  
**1SC-1SN 2SC-2SN**  
**4SP-4SH-4SS**  
 (NO RECOMENDABLE PARA TRABAJAR CON IMPULSOS)

### PRINCIPALES VENTAJAS

#### Mayor durabilidad y vida útil

La resistencia superior a la corrosión protege los racores de forma duradera frente a agentes externos, incluso en entornos exigentes. Esto se traduce en una mayor vida útil del sistema y una reducción significativa de paradas no programadas.

#### Menor mantenimiento

Gracias al tratamiento anticorrosivo, se minimizan las necesidades de mantenimiento y sustitución de componentes, lo que ahorra tiempo, costes y recursos, especialmente en zonas de difícil acceso.

#### Acabado profesional

El recubrimiento no solo cumple una función técnica, sino que también aporta un aspecto uniforme y de alta calidad, ideal para equipos con componentes visibles.

#### Compatibilidad con diferentes materiales

La superficie de Zinc-Níquel reduce el riesgo de corrosión por contacto en sistemas con conexiones mixtas (como aluminio o acero inoxidable), protegiendo la integridad de toda la instalación.

#### Superficie pintable

El recubrimiento permite su pintado posterior, facilitando la personalización según el diseño corporativo, codificación por colores o requerimientos específicos de cada proyecto.

#### Seguro para el contacto humano

Gracias a su bajo contenido en níquel, el riesgo de reacciones alérgicas es mínimo, lo que lo hace apto para aplicaciones donde puede haber contacto con la piel, como tareas de montaje o mantenimiento.

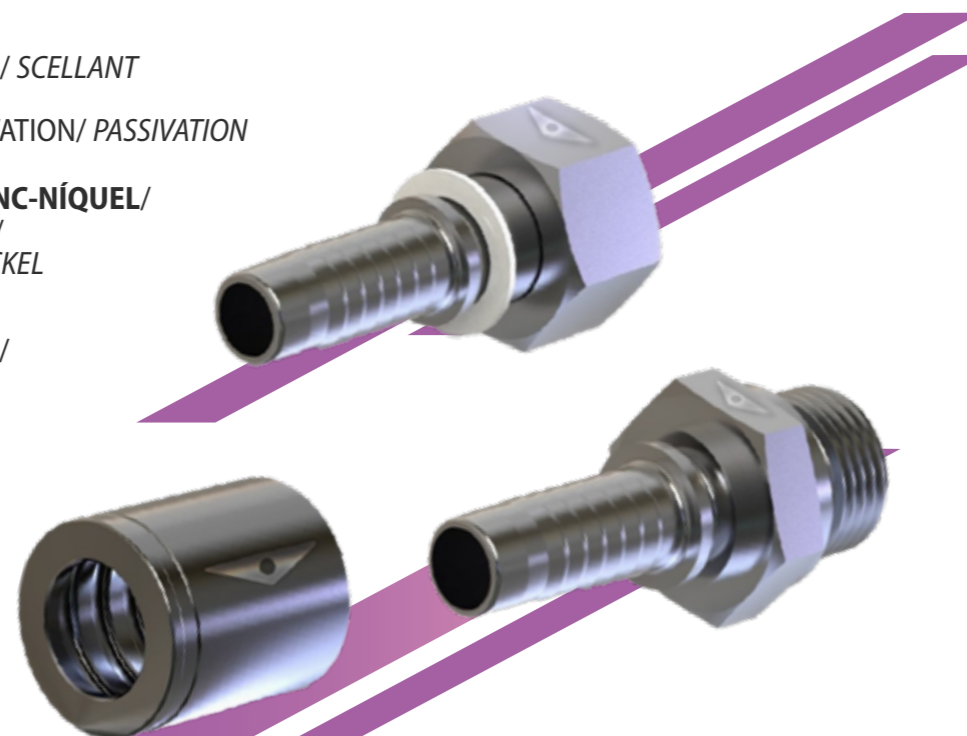

# HOSE FITTINGS RAPZ

## INTRODUCING THE NEW VINCKE HOSE FITTINGS WITH ZINC-NICKEL COATING

At Vincke, we continuously innovate to deliver more reliable, durable, and high-performance solutions.

Our latest addition: hose fittings with a zinc-nickel surface treatment, designed to enhance the performance and protection of your hydraulic systems.

Zn-Ni coat resists 720 hours without white rust, and 1500 hours without red rust (Salt spray test).

Zinc-nickel coating and sealing layer with uniform thickness, stable friction coefficient and wear resistance of the coating.

The subsequent passivation and sealing phase have made it possible to achieve technical performance and resistance to red corrosion that are significantly higher than normal standards, in fact according to UNI ISO 9227.

**COMPATIBLE WITH:**  
**1SC-1SN 2SC-2SN**  
**4SP-4SH-4SS**  
 (NOT RECOMMENDED FOR IMPULSE PRESSURE APPLICATIONS)

### KEY ADVANTAGES

#### Extended service life

Exceptional corrosion resistance offers long-lasting protection against environmental conditions, even in harsh applications.

#### Reduced maintenance requirements

Thanks to the anti-corrosion properties, component maintenance and replacement are minimized.

#### High-quality finish

Beyond its technical benefits, the surface provides a clean, professional look.

#### Compatible with dissimilar materials

The zinc-nickel coating reduces the risk of contact corrosion, especially in systems with mixed connections (such as aluminium or stainless steel).

#### Paintable surface

The coating can be easily painted.

#### Skin-safe and low allergenic risk

With a very low nickel content, important in scenarios involving frequent handling, assembly, or maintenance.

# RACCORDS-RAPZ

## PRÉSENTATION DES NOUVEAUX RACCORDS SERTIS VINCKE AVEC TRAITEMENT ZINC-NICKEL

Chez Vincke, nous innovons constamment pour offrir des solutions toujours plus durables, performantes et sûres. Nos nouveaux raccords sertis avec revêtement en zinc-nickel sont conçus pour améliorer la fiabilité et la longévité de vos installations hydrauliques.

Le revêtement Zn-Ni offre une résistance exceptionnelle, pouvant résister jusqu'à 720 heures sans corrosion blanche et 1500 heures sans corrosion rouge dans les tests de brouillard salin.

Ce revêtement de zinc-nickel, avec la couche d'étanchéité, offre une épaisseur uniforme, un coefficient de frottement stable et une excellente résistance à l'usure.

La phase de passivation et d'étanchéification ultérieure permet d'atteindre des performances techniques et une résistance à la corrosion largement supérieures aux normes habituelles.

Conformément à la norme UNI ISO 9227.

**COMPATIBLES AVEC DES TUYAUX HYDRAULIQUES:**  
**1SC-1SN 2SC-2SN**  
**4SP-4SH-4SS**  
 (NON RECOMMANDÉS POUR DES APPLICATIONS AVEC IMPULSIONS)

### AVANTAGES PRINCIPAUX

#### Durée de vie prolongée

Grâce à leur résistance exceptionnelle à la corrosion, les raccords sont durablement protégés contre les agressions extérieures, même dans des environnements difficiles. Cela permet de prolonger la durée de vie des systèmes.

#### Entretien réduit

Le traitement anticorrosion limite considérablement les besoins en maintenance et en remplacement.

#### Finition de qualité supérieure

Outre sa fonction protectrice, la surface offre un aspect esthétique homogène et professionnel, idéal pour les composants visibles sur les machines ou équipements.

#### Compatibilité avec différents matériaux

Le revêtement zinc-nickel diminue les risques de corrosion de contact, notamment dans les systèmes avec raccords mixtes (aluminium, inox...).

#### Surface facilement peignable

La surface peut être repeinte sans difficulté.

#### Sûr pour un contact avec la peau

Avec une très faible teneur en nickel, ce qui rend ces raccords adaptés aux applications avec manipulation fréquente ou contact direct.

**CONEXIONES PRENSAR 1SC 1SN 2SC 2SNK 4SP 4SH Zn-Ni**  
CRIMPING FITTINGS 1SC 1SN 2SC 2SNK 4SP 4SH Zn-Ni  
CONNEXIONS A SERTIR 1SC 1SN 2SC 2SNK 4SP 4SH Zn-Ni

**1SC 1SN 2SC 2SN 2SNK Zi-Ni**  
1SC 1SN 2SC 2SN 2SNK Zi-Ni  
1SC 1SN 2SC 2SN 2SNK Zi-Ni

**CASQUILLO 4SP - 4SS+ - 4SH NO PELADO EXTERNO**

4SP - 4SS+ - 4SH FERRULE NOT OUTER SKIVE  
JUPE 4SP - 4SS+ - 4SH SANS DÉNUDAGE EXTÉRIEUR



Ref.		€
RAPZ004N0006	3/8	4,60
RAPZ004N0008	1/2	5,42
RAPZ004N0010	5/8	6,34
RAPZ004N0012	3/4	7,85
RAPZ004N0016	1"	12,51

**CASQUILLO 1SN/2SN/2SC 2SNK Zi-Ni VINCKE**

1SN/2SN/2SC 2SNK Zi-Ni FERRULE VINCKE  
JUPE 1SN/2SN/2SC 2SNK Zi-Ni VINCKE

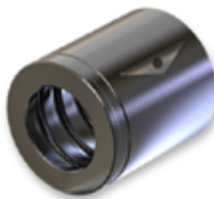

Ref.		€
RAPZ00550004	1/4	1,83
RAPZ00550005	5/16	2,34
RAPZ00550006	3/8	2,48
RAPZ00550008	1/2	3,22
RAPZ00550010	5/8	4,30
RAPZ00550012	3/4	5,60
RAPZ00550016	1	15,46
RAPZ00550020	1" 1/4	30,87

**RACORES PRENSAR BSP Zi-Ni**  
BSP HOSE FITTINGS Zi-Ni  
BSP RACCORD À SERTIR Zi-Ni

**HEMBRA GIRATORIA BSP CONO 60° Zi-Ni**

60° BSP CONE SWIVEL FEMALE Zi-Ni  
FEMELLE TOURNANTE BSP CONE 60° Zi-Ni



Ref.			€
RAPZ10110404	1/4	1/4	2,47
RAPZ10110604	3/8	1/4	3,27
RAPZ10110605	3/8	5/16	3,32
RAPZ10110606	3/8	3/8	3,37
RAPZ10110804	1/2	1/4	4,46
RAPZ10110806	1/2	3/8	4,27
RAPZ10110808	1/2	1/2	4,28
RAPZ10111212	3/4	3/4	7,32
RAPZ10111612	1"	3/4	12,87
RAPZ10111616	1"	1	11,16
RAPZ10112020	1" 1/4	1" 1/4	24,71

**MACHO FIJO BSP Zi-Ni**

BSP STUD MALE Zi-Ni  
MÂLE FIXE BSP Zi-Ni



Ref.			€
RAPZ10130404	1/4	1/4	3,24
RAPZ10130604	3/8	1/4	3,74
RAPZ10130605	3/8	5/16	4,18
RAPZ10130606	3/8	3/8	3,56
RAPZ10130608	3/8	1/2	5,63
RAPZ10130804	1/2	1/4	9,11
RAPZ10130806	1/2	3/8	5,24
RAPZ10130808	1/2	1/2	4,97
RAPZ10131212	3/4	3/4	9,67
RAPZ10131612	1"	3/4	25,18
RAPZ10131616	1"	1	19,01
RAPZ10132020	1" 1/4	1" 1/4	36,24

**HEMBRA GIRATORIA 90° BSP Zi-Ni**  
90° BSP SWIVEL FEMALE Zi-Ni  
FEMELLE TOURNANTE 90° BSP Zi-Ni



**RAC. PREN. Zi-Ni C 90° 1/4 BSP MAN. 1/490° BSP**  
CRIMP. FIT. Zi-Ni ELBOW 90° 1/4 BSP HOSE 1/4  
RAC. À SERTIR Zi-Ni C 90° 1/4 BSP TUY. 1/4

Ref.			€
RAPZ10150404	1/4	1/4	4,53
RAPZ10150604	3/8	1/4	5,55
RAPZ10150605	3/8	5/16	6,07
RAPZ10150606	3/8	3/8	5,40
RAPZ10150608	3/8	1/2	22,97
RAPZ10150806	1/2	3/8	6,94
RAPZ10150808	1/2	1/2	7,02
RAPZ10151212	3/4	3/4	14,22
RAPZ10151612	1"	3/4	27,41
RAPZ10151616	1"	1	26,67
RAPZ10152020	1" 1/4	1" 1/4	61,42

**HEMBRA GIRATORIA 45° BSP Zi-Ni**  
45° BSP SWIVEL FEMALE Zi-Ni  
FEMELLE TOURNANTE 45° BSP Zi-Ni



Ref.			€
RAPZ10160404	1/4	1/4	4,83
RAPZ10160604	3/8	1/4	9,81
RAPZ10160606	3/8	3/8	6,32
RAPZ10160806	1/2	3/8	11,48
RAPZ10160808	1/2	1/2	7,73
RAPZ10161212	3/4	3/4	14,02
RAPZ10161612	1"	3/4	43,81
RAPZ10161616	1"	1	23,18
RAPZ10162020	1" 1/4	1" 1/4	65,98

**HEMBRA GIRATORIA 90° BSP Zi-Ni**  
90° BSP SWIVEL FEMALE Zi-Ni  
FEMELLE TOURNANTE 90° BSP Zi-Ni

**ESFÉRICO BSP**  
BSP BANJO  
BANJO BSP



Ref.	∅		€
RAPZ10340404	1/4	1/4	5,05
RAPZ10340406	1/4	3/8	8,36
RAPZ10340604	3/8	1/4	8,10
RAPZ10340605	3/8	5/16	6,14
RAPZ10340606	3/8	3/8	6,19
RAPZ10340806	1/2	3/8	14,18
RAPZ10340808	1/2	1/2	14,10
RAPZ10341212	3/4	3/4	46,66

**RACOR PRENSAR SAE JIC**  
SAE JIC HOSE FITTING  
RACCORD À SERTIR SAE JIC

**HEMBRA GIRATORIA SAE JIC**  
SAE JIC SWIVEL FEMALE  
FEMELLE TOURNANTE SAE JIC



Ref.			€
RAPZ10410404	7/16	1/4	3,38
RAPZ10410504	1/2	1/4	3,42
RAPZ10410604	9/16	1/4	3,66
RAPZ10410606	9/16	3/8	3,59
RAPZ10410806	3/4	3/8	5,00
RAPZ10410808	3/4	1/2	5,05
RAPZ10411008	7/8	1/2	6,09
RAPZ10411010	7/8	5/8	7,34
RAPZ10411208	1" 1/16	1/2	11,49
RAPZ10411210	1" 1/16	5/8	8,09
RAPZ10411212	1" 1/16	3/4	8,57
RAPZ10411616	1" 5/16	1	15,08
RAPZ10412020	1" 5/8	1" 1/4	28,28

**MACHO FIJO SAE JIC**  
SAE JIC STUD MALE  
MÂLE FIXE SAE JIC



Ref.			€
RAPZ10430404	7/16	1/4	3,71
RAPZ10430604	9/16	1/4	4,68
RAPZ10430606	9/16	3/8	3,26
RAPZ10430806	3/4	3/8	4,14
RAPZ10430808	3/4	1/2	4,62
RAPZ10431008	7/8	1/2	6,22
RAPZ10431212	1" 1/16	3/4	14,39
RAPZ10431616	1" 5/16	1	17,19
RAPZ10432020	1" 5/8	1"1/4	43,79

**HEMBRA GIRATORIA 90° SAE JIC**  
90° SAE JIC SWIVEL FEMALE  
FEMELLE TOURNANTE 90° SAE JIC



Ref.			€
RAPZ10450404	7/16	1/4	6,25
RAPZ10450604	9/16	1/4	6,87
RAPZ10450606	9/16	3/8	7,76
RAPZ10450806	3/4	3/8	7,78
RAPZ10450808	3/4	1/2	14,02
RAPZ10451008	7/8	1/2	12,61
RAPZ10451010	7/8	5/8	15,91
RAPZ10451212	1" 1/16	3/4	16,83
RAPZ10451612	1" 5/16	3/4	44,00
RAPZ10451616	1" 5/16	1	36,91
RAPZ10452020	1" 5/8	1"1/4	77,18

**HEMBRA GIRATORIA 45° SAE JIC**  
45° SAE JIC SWIVEL FEMALE  
FEMELLE TOURNANTE 45° SAE JIC



Ref.			€
RAPZ10460404	7/16	1/4	7,96
RAPZ10460604	9/16	1/4	7,27
RAPZ10460606	9/16	3/8	7,28
RAPZ10460806	3/4	3/8	8,75
RAPZ10460808	3/4	1/2	11,30
RAPZ10461008	7/8	1/2	10,69
RAPZ10461212	1" 1/16	3/4	21,79
RAPZ10461616	1" 5/16	3/4	36,73

**RACOR PRENSAR MÉTRICO SERIE LIGERA**  
METRIC HOSE FITTING L SERIES  
RACCORD À SERTIR MÉTRIQUE SÉRIE LÉGÈRE

**HEMBRA GIRATORIA MÉTRICA SERIE LIGERA**  
METRIC SWIVEL FEMALE LIGHT SERIES  
FEMELLE TOURNANTE MÉTRIQUE SÉRIE LÉGÈRE



Ref.	Ø			€
RAPZ10811204	6	12x150	1/4	8,22
RAPZ10811404	8	14x150	1/4	3,17
RAPZ10811604	10	15x150	1/4	4,00
RAPZ10811606	10	16x150	3/8	7,89
RAPZ10811804	12	18x150	1/4	5,06
RAPZ10811805	12	18x150	5/16	6,14
RAPZ10811806	12	18x150	3/8	3,56
RAPZ10812206	15	22x150	3/8	7,34
RAPZ10812208	15	22x150	1/2	5,01
RAPZ10812608	18	26x150	1/2	14,89
RAPZ10812610	18	26x150	5/8	7,39
RAPZ10812612	18	26x150	3/4	11,19
RAPZ10813010	22	30x200	5/8	17,72
RAPZ10813012	22	30x200	3/4	10,76
RAPZ10813616	28	36x200	1	18,83
RAPZ10814520	35	45x200	1"1/4	29,40
RAPZ10815224	42	52x200	1"1/2	55,59

**HEMBRA GIRATORIA 90° MÉTRICA SERIE LIGERA**  
90° METRIC SWIVEL FEMALE LIGHT SERIES  
FEMELLE TOURNANTE 90° MÉTRIQUE SÉRIE LÉGÈRE



Ref.	Ø			€
RAPZ10851204	6	12x150	1/4	21,03
RAPZ10851404	8	14x150	1/4	6,27
RAPZ10851604	10	16x150	1/4	6,44
RAPZ10851605	10	16x150	5/16	8,51
RAPZ10851606	10	16x150	3/8	11,59
RAPZ10851804	12	18x150	1/4	9,18
RAPZ10851805	12	18x150	5/16	11,59
RAPZ10851806	12	18x150	3/8	6,86
RAPZ10852206	15	22x150	3/8	9,84
RAPZ10852208	15	22x150	1/2	10,11
RAPZ10852610	18	26x150	5/8	14,46
RAPZ10852612	18	36x200	3/4	36,14
RAPZ10853012	22	30x200	3/4	18,92
RAPZ10853616	28	36x200	1	39,41
RAPZ10854520	35	45x200	1"1/4	72,49
RAPZ10855224	42	52x200	1"1/2	137,01

### HEMBRA GIRATORIA 45° MÉTRICA SERIE LIGERA

45° METRIC SWIVEL FEMALE LIGHT SERIES

FEMELLE TOURNANTE 45° MÉTRIQUE SÉRIE LÉGÈRE



Ref.	∅			€
RAPZ10861204	6	12x150	1/4	10,62
RAPZ10861404	8	14x150	1/4	6,93
RAPZ10861604	10	16x150	1/4	9,71
RAPZ10861605	10	16x150	5/16	8,93
RAPZ10861606	10	16x150	3/8	15,05
RAPZ10861804	12	18x150	1/4	11,71
RAPZ10861805	12	18x150	5/16	15,05
RAPZ10861806	12	18x150	3/8	9,04
RAPZ10862208	15	22x150	1/2	11,73
RAPZ10862610	18	26x150	5/8	17,96
RAPZ10863012	22	30x200	3/4	24,75
RAPZ10863616	28	36x200	1	36,05
RAPZ10864520	35	45x200	1"1/4	74,35
RAPZ10865224	42	52x200	1"1/2	175,91

### MACHO FIJO MÉTRICO SERIE LIGERA

METRIC STUD MALE LIGHT SERIES

MÂLE FIXE MÉTRIQUE SÉRIE LÉGÈRE



Ref.	∅			€
RAPZ10631204	6	12x150	1/4	4,04
RAPZ10631404	8	14x150	1/4	3,09
RAPZ10631604	10	16x150	1/4	5,01
RAPZ10631605	10	16x150	5/16	4,10
RAPZ10631606	10	16x150	3/8	4,53
RAPZ10631804	12	18x150	1/4	6,12
RAPZ10631805	12	18x150	5/16	6,12
RAPZ10631806	12	18x150	3/8	3,64
RAPZ10632206	15	22x150	3/8	7,49
RAPZ10632208	15	22x150	1/2	5,40
RAPZ10632608	18	26x150	1/2	10,98
RAPZ10632610	18	26x150	5/8	11,13
RAPZ10633012	22	30x200	3/4	12,23
RAPZ10633616	28	36x200	1"	20,20
RAPZ10634520	35	45x200	1" 1/4	34,37
RAPZ10635224	42	52x200	1" 1/2	51,12

### RACOR PRENSAR MÉTRICO SERIE LIGERA

METRIC HOSE FITTING L SERIES

RACCORD À SERTIR MÉTRIQUE SÉRIE LÉGÈRE

### HEMBRA GIRATORIA MÉTRICA SERIE PESADA

METRIC SWIVEL FEMALE HEAVY SERIES

FEMELLE TOURNANTE MÉTRIQUE SÉRIE LOURDE



Ref.	∅			€
RAPZ10911404	6	14x150	1/4	11,96
RAPZ10911604	8	16x150	1/4	3,74
RAPZ10911804	10	18x150	1/4	5,13
RAPZ10911806	10	18x150	3/8	8,64
RAPZ10912004	12	20x150	1/4	6,50
RAPZ10912005	12	20x150	5/16	5,15
RAPZ10912006	14	22x150	3/8	7,71
RAPZ10912208	14	22x150	1/2	11,19
RAPZ10912408	16	24x150	1/2	6,50
RAPZ10913010	20	30x200	5/8	10,24
RAPZ10913012	20	30x200	3/4	12,60
RAPZ10913612	25	36x200	3/4	19,54
RAPZ10913616	25	36x200	1	27,51
RAPZ10914216	30	42x200	1	25,44
RAPZ10915220	38	52x200	1"1/4	56,75

### HEMBRA GIRATORIA 90° MÉTRICA SERIE PESADA

90° METRIC SWIVEL FEMALE HEAVY SERIES

FEMELLE TOURNANTE 90° MÉTRIQUE SÉRIE LOURDE



Ref.	∅			€
RAPZ10951404	6	14x150	1/4	7,78
RAPZ10951604	8	16x150	1/4	8,24
RAPZ10951804	10	18x150	1/4	8,07
RAPZ10952005	12	20x150	5/16	11,45
RAPZ10952006	12	20x150	3/8	10,31
RAPZ10952206	14	22x150	3/8	14,42
RAPZ10952208	14	22x150	1/2	21,97
RAPZ10952408	16	24x150	1/2	10,98
RAPZ10953010	20	30x200	5/8	18,58
RAPZ10953012	20	30x200	3/4	28,94
RAPZ10953612	25	36x200	3/4	35,92
RAPZ10953616	25	36x200	1	59,25
RAPZ10954216	30	42x200	1	55,86
RAPZ10955220	38	52x200	1"1/4	91,03



**HEMBRA GIRATORIA 45° MÉTRICA SERIE PESADA**  
45° METRIC SWIVEL FEMALE HEAVY SERIES  
FEMELLE TOURNANTE 45° MÉTRIQUE SÉRIE LOURDE

Ref.	∅			€
RAPZ10961404	6	14x150	1/4	15,66
RAPZ10961604	8	16x150	1/4	10,72
RAPZ10961804	10	18x150	1/4	10,52
RAPZ10961806	12	18x150	3/8	21,97
RAPZ10962005	12	20x150	5/16	12,47
RAPZ10962006	12	20x150	3/8	11,44
RAPZ10962206	14	22x150	3/8	15,05
RAPZ10962208	14	22x150	1/2	21,97
RAPZ10962408	16	24x150	1/2	12,98
RAPZ10963010	20	30x200	5/8	21,91
RAPZ10963612	25	36x200	3/4	36,79
RAPZ10963616	25	36x200	1	62,20
RAPZ10964216	30	42x200	1	51,58
RAPZ10965220	38	52x200	1"1/4	105,34



**MACHO FIJO MÉTRICO SERIE PESADA**  
METRIC STUD MALE HEAVY SERIES  
MÂLE FIXE MÉTRIQUE SÉRIE LOURDE

Ref.	∅			€
RAPZ10731404	6	14x150	1/4	6,27
RAPZ10731604	8	16x150	1/4	6,04
RAPZ10731804	10	18x150	1/4	6,15
RAPZ10731805	10	18x150	5/16	7,40
RAPZ10731806	10	18x150	3/8	7,08
RAPZ10732005	12	20x150	5/16	7,96
RAPZ10732006	12	20x150	3/8	6,35
RAPZ10732206	14	22x150	3/8	5,96
RAPZ10732208	14	22x150	1/2	6,42
RAPZ10732408	16	24x150	1/2	5,95
RAPZ10733010	20	30x200	5/8	11,11
RAPZ10733012	20	30x200	3/4	9,92
RAPZ10733612	25	36x200	3/4	15,55
RAPZ10733616	25	36x200	1	22,56
RAPZ10734216	30	42x200	1	27,55
RAPZ10735220	38	52x200	1"1/4	44,00



**INNOVACIÓN**  
INNOVATION  
INNOVATION



**CALIDAD/PRECIO**  
QUALITY/PRICE  
QUALITÉ/PRIX



**CALIDAD**  
QUALITY  
QUALITÉ

# VINCKE



**PROXIMIDAD Y  
RAPIDEZ**  
PROXIMITY AND  
SPEED  
PROXIMITÉ ET  
RAPIDITÉ



**AMPLIA GAMA**  
WIDE RANG  
LARGE GAMME



**LOGISTICA**  
LOGISTICS  
LOGISTIQUE

# VINCKE 1SC-2SC TWIN

## MANGUERA HIDRÁULICA 1SC-2SC TWIN PARA CARRETILLAS ELEVADORAS

### VENTAJAS PRINCIPALES

- Alta flexibilidad: facilita en espacios reducidos el enrutamiento
- Bajo cambio de longitud: evita deslizamientos y reduce el mantenimiento
- Gran resistencia a la abrasión: soporta el roce continuo con poleas y cadenas
- Larga vida útil: probada con más de 250.000 ciclos de presión
- Compatibilidad total: dimensiones adaptadas a los estándares OEM
- Aprobación MSHA

1SC-2SC TWIN Smooth son las mangueras ideales para sistemas hidráulicos de carretillas elevadoras.

Su diseño compacto y flexible permite una instalación rápida y sencilla en el mástil, con excelente resistencia a la abrasión, el desgaste y el movimiento continuo.

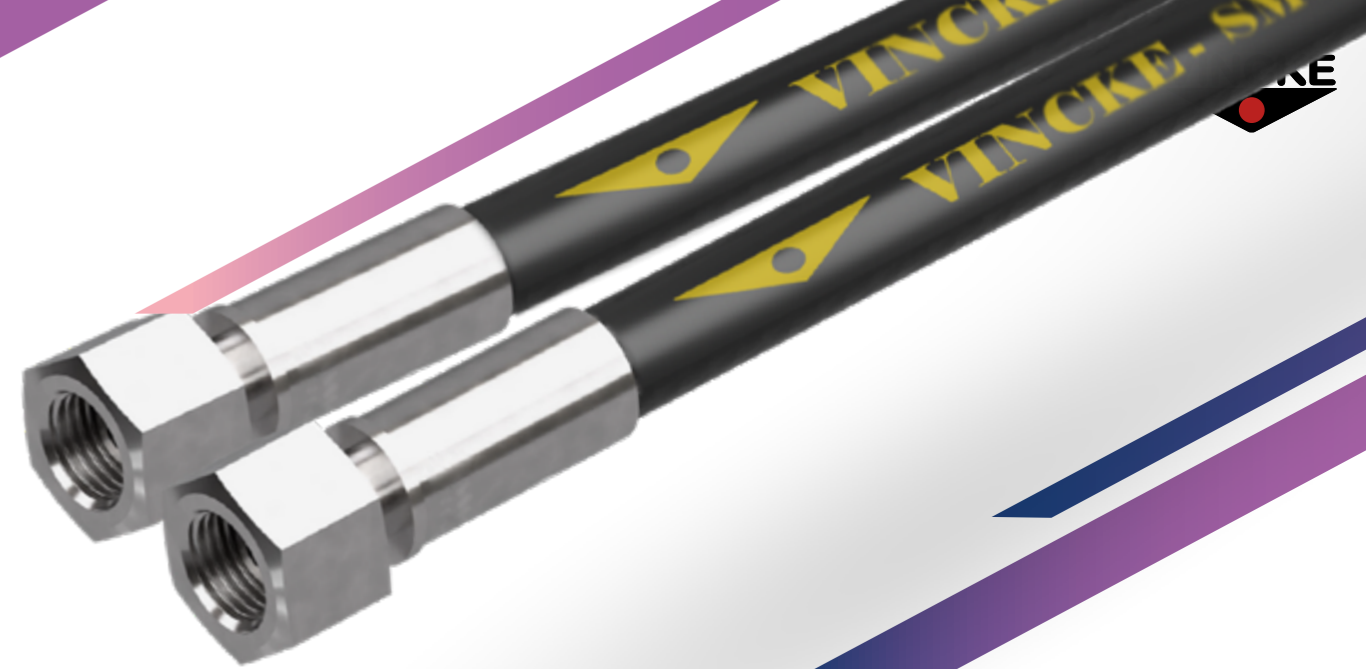

## 1SC-2SC TWIN HYDRAULIC HOSE FOR FORKLIFTS

### KEY BENEFITS

- High flexibility: quick and easy routing in tight spaces
- Low length variation: reduces slippage and maintenance
- Abrasion resistance: withstands constant contact with sheaves and chains
- Long service life: tested over 250,000 pressure cycles
- OEM compatibility: hose OD fits standard sheaves and clamps
- MSHA approved

The 1SC-2SC TWIN Smooth are the ideal hoses for forklift hydraulic systems. Compact and highly flexible, it ensures easy installation on the mast, with excellent abrasion resistance and durability under continuous movement.

## TUYAU HYDRAULIQUE 1SC-2SC TWIN POUR CHARIOTS ÉLEVATEURS

### PRINCIPAUX AVANTAGES

- Grande flexibilité: installation facile dans les espaces restreints
- Faible variation de longueur: évite les glissements et réduit la maintenance
- Résistance à l'abrasion: conçu pour les frottements continus sur poulies et chaînes
- Durée de vie prolongée: testé à plus de 250.000 cycles sous pression
- Compatibilité OEM: dimensions adaptées aux gorges et colliers standards
- Homologation MSHA

Le 1SC-2SC TWIN 1SC-2SC TWIN sont les tuyaux idéaux pour les systèmes hydrauliques de chariots élévateurs.

Flexible et compact, il s'installe facilement sur le mât du chariot, tout en offrant une excellente résistance à l'usure, aux frottements et aux mouvements répétés.

**CONEXIONES PRENSAR UNA PIEZA 1SN-2SC-2SN-2SNK-4SP**  
**CRIMPING FITTINGS ONE PIECE 1SN-2SC-2SN-2SNK-4SP**  
**CONNEXIONS A SERTIR UNE PIÈCE 1SN-2SC-2SN-2SNK-4SP**

**HEMBRA GIRATORIA BSPP**  
BSPP SWIVEL FEMALE  
FEMELLE TOURNANTE BSPP



Ref.			€
RACG10110204	1/8	1/4	4,87
RACG10110404	1/4	1/4	3,64
RACG10110604	3/8	1/4	4,87
RACG10110605	3/8	5/16	6,89
RACG10110606	3/8	3/8	4,34
RACG10110804	1/2	1/4	12,97
RACG10110806	1/2	3/8	5,05

**MACHO FIJO BSPP**  
BSPP STUD MALE  
MÂLE FIXE BSPP



Ref.			€
RACG10130404	1/4	1/4	4,30
RACG10130604	3/8	1/4	4,84
RACG10130405	1/4	5/16	9,23
RACG10130605	3/8	5/16	9,05
RACG10130606	3/8	3/8	5,16
RACG10130804	1/2	1/4	10,67
RACG10130806	1/2	3/8	6,13

**HEMBRA GIRATORIA 90° BSPP**  
90° BSPP SWIVEL FEMALE  
FEMELLE TOURNANTE 90° BSPP



Ref.			€
RACG10150404	1/4	1/4	5,57
RACG10150604	3/8	1/4	7,07
RACG10150605	3/8	5/16	10,93
RACG10150606	3/8	3/8	6,94
RACG10150806	1/2	3/8	8,54
RACG10150808	1/2	1/2	8,95

**HEMBRA GIRATORIA 90° BSPP - CORTO**  
90° BSPP SWIVEL FEMALE - SHORT  
FEMELLE TOURNANTE 90° BSPP COURTE



Ref.			€
RACG10150404C	1/4	1/4	22,29
RACG10150606C	3/8	3/8	29,62
RACG10150808C	1/2	1/2	38,23
RACG10151212C	3/4	3/4	49,45

Ref.			€
RACG10110808	1/2	1/2	6,16
RACG10111010	5/8	5/8	7,93
RACG10111208	3/4	1/2	13,14
RACG10111210	3/4	5/8	9,24
RACG10111212	3/4	3/4	13,14
RACG10111612	1"	3/4	15,66
RACG10111616	1"	1"	21,43

Ref.			€
RACG10130808	1/2	1/2	6,76
RACG10131010	5/8	5/8	11,02
RACG10131210	3/4	5/8	12,01
RACG10131212	3/4	3/4	11,50
RACG10131612	1"	3/4	20,08
RACG10131616	1"	1"	25,07

Ref.			€
RACG10151010	5/8	5/8	13,95
RACG10151210	3/4	5/8	17,00
RACG10151212	3/4	3/4	15,60
RACG10151612	1"	3/4	25,02
RACG10151616	1"	1"	26,02



**HEMBRA GIRATORIA 45° BSPP**  
45° BSPP SWIVEL FEMAL  
FEMELLE TOURNANTE 45° BSPP

Ref.			€
RACG10160404	1/4	1/4	5,54
RACG10160604	3/8	1/4	7,07
RACG10160605	3/8	5/16	10,93
RACG10160606	3/8	3/8	6,94
RACG10160808	1/2	1/2	9,25
RACG10161010	5/8	5/8	13,81
RACG10161210	3/4	5/8	16,91
RACG10161212	3/4	3/4	15,60
RACG10161612	1"	3/4	31,07
RACG10161616	1"	1"	31,47

**MACHO NPTF**  
NPTF MALE  
MÂLE NPTF



Ref.			€
RACG10230404	1/4	1/4	4,78
RACG10230604	3/8	1/4	5,16
RACG10230606	3/8	3/8	6,21
RACG10230806	1/2	3/8	6,37
RACG10230808	1/2	1/2	6,88
RACG10231212	3/4	3/4	15,51
RACG10231612	1"	3/4	34,18
RACG10231616	1"	1"	24,74

**MACHO BSPT**  
BSPT MALE  
MÂLE BSPT



Ref.			€
RACG10330404	1/4	1/4	5,98
RACG10330606	3/8	3/8	6,21
RACG10330808	1/2	1/2	7,96
RACG10331212	3/4	3/4	13,86
RACG10331616	1"	1"	22,73

**ESFÉRICO BSPP - MÉTRICO**  
METRIC BSPP BANJO  
BANJO BSPP - MÉTRIQUE



Ref.	Ø		€
RACG10340404	1/4	1/4	7,29
RACG10340604	3/8	1/4	6,65
RACG10340605	3/8	5/16	11,01
RACG10340606	3/8	3/8	8,48
RACG10340806	1/2	3/8	12,16
RACG10340808	1/2	1/2	13,76
RACG10341212	3/4	3/4	26,06

Ref.	Ø		€
RACG10341616	1"	1"	68,60
RACG10341404	14	1/4	9,63
RACG10341606	16	3/8	8,25
RACG10341806	18	3/8	9,22
RACG10342006	20	3/8	22,62
RACG10342208	22	1/2	12,97

**RACOR SAE JIC**  
SAE JIC SYSTEM  
SAE JIC RACCORD



**HEMBRA GIRATORIA SAE JIC**  
SAE JIC SWIVEL FEMALE  
FEMELLE TOURNANTE SAE JIC

Ref.	Ø	Ø	€
RACG10410404	7/16	1/4	3,94
RACG10410504	1/2	1/4	4,62
RACG10410604	9/16	1/4	4,87
RACG10410605	9/16	5/16	7,07
RACG10410606	9/16	3/8	4,89
RACG10410806	3/4	3/8	5,45
RACG10410808	3/4	1/2	6,19

**MACHO FIJO SAE JIC**  
SAE JIC STUD MALE  
MÂLE LE FIXE SAE JIC



Ref.	Ø	Ø	€
RACG10430404	7/16	1/4	4,62
RACG10430504	1/2	1/4	4,92
RACG10430604	9/16	1/4	5,16
RACG10430605	9/16	5/16	8,93
RACG10430606	9/16	3/8	5,16
RACG10430806	3/4	3/8	5,39
RACG10430808	3/4	1/2	6,22

**HEMBRA GIRATORIA 90° SAE JIC**  
90° SAE JIC SWIVEL FEMALE  
FEMELLE TOURNANTE 90° SAE JIC



Ref.	Ø	Ø	€
RACG10450404	7/16	1/4	6,71
RACG10450504	1/2	1/4	8,27
RACG10450604	9/16	1/4	8,27
RACG10450605	9/16	5/16	11,33
RACG10450606	9/16	3/8	8,59
RACG10450806	3/4	3/8	8,82
RACG10450808	3/4	1/2	10,58

**HEMBRA GIRATORIA 45° SAE JIC**  
45° SAE JIC SWIVEL FEMALE  
FEMELLE TOURNANTE 45° SAE JIC



Ref.	Ø	Ø	€
RACG10460404	7/16	1/4	6,71
RACG10460504	1/2	1/4	8,27
RACG10460604	9/16	1/4	8,27
RACG10460605	9/16	5/16	11,33
RACG10460606	9/16	3/8	8,59
RACG10460806	3/4	3/8	8,82
RACG10460808	3/4	1/2	10,58

**MÉTRICO SERIE LIGERA**  
LIGHT SERIES FITTING  
MÉTRIQUE SÉRIE LÉGÈRE



**HEMBRA GIRATORIA MÉTRICA SERIE LIGERA**  
METRIC SWIVEL FEMALE LIGHT SERIES  
FEMELLE TOURNANTE MÉTRIQUE SÉRIE LÉGÈRE

Ref.	Ø	Ø	Ø	€
RACG10811204	6	12x150	1/4	6,41
RACG10811404	8	14x150	1/4	5,12
RACG10811604	10	16x150	1/4	4,63
RACG10811605	10	16x150	5/16	7,02
RACG10811606	10	16x150	3/8	8,53
RACG10811804	12	18x150	1/4	7,44
RACG10811805	12	18x150	5/16	8,60

Ref.	Ø	Ø	Ø	€
RACG10811806	12	18x150	3/8	4,35
RACG10811808	12	18x150	1/2	9,97
RACG10812206	15	22x150	3/8	9,25
RACG10812208	15	22x150	1/2	7,95
RACG10812610	18	26x150	5/8	12,04
RACG10813012	22	30x200	3/4	14,01
RACG10813616	28	36x200	1"	23,88

**MACHO FIJO MÉTRICO SERIE LIGERA**  
METRIC STUD MALE LIGHT SERIES  
MÂLE FIXE MÉTRIQUE SÉRIE LÉGÈRE



Ref.	Ø	Ø	Ø	€
RACG10631204	6	12x150	1/4	5,90
RACG10631404	8	14x150	1/4	4,71
RACG10631604	10	16x150	1/4	4,78
RACG10631605	10	16x150	5/16	7,30
RACG10631606	10	16x150	3/8	6,37
RACG10631805	12	18x150	5/16	7,53

Ref.	Ø	Ø	Ø	€
RACG10631806	12	18x150	3/8	5,24
RACG10632206	15	22x150	3/8	11,32
RACG10632208	15	22x150	1/2	6,10
RACG10632610	18	26x150	5/8	17,29
RACG10633012	22	30x200	3/4	17,30
RACG10633616	28	36x200	1"	24,01

**HEMBRA GIRATORIA 90° SERIE LIGERA**  
90° SWIVEL FEMALE LIGHT SERIES  
FEMELLE TOURNANTE 90° SÉRIE LÉGÈRE



Ref.	Ø	Ø	Ø	€
RACG10851204	6	12x150	1/4	7,59
RACG10851404	8	14x150	1/4	7,79
RACG10851604	10	16x150	1/4	6,39
RACG10851605	10	16x150	5/16	9,63
RACG10851606	10	16x150	3/8	10,77
RACG10851805	12	18x150	5/16	12,77

Ref.	Ø	Ø	Ø	€
RACG10851806	12	18x150	3/8	8,92
RACG10852208	15	22x150	1/2	11,92
RACG10852610	18	26x150	5/8	24,45
RACG10853012	22	30x200	3/4	28,13
RACG10853616	28	36x200	1"	39,24

**HEMBRA GIRATORIA 45° SERIE LIGERA**  
45° SWIVEL FEMALE LIGHT SERIES  
FEMELLE TOURNANTE 45° SÉRIE LÉGÈRE



Ref.	Ø	Ø	Ø	€
RACG10861404	8	14x150	1/4	7,79
RACG10861604	10	16x150	1/4	6,75
RACG10861605	10	16x150	5/16	10,14
RACG10861805	12	18x150	5/16	12,77
RACG10861806	12	18x150	3/8	8,92

Ref.	Ø	Ø	Ø	€
RACG10862208	15	22x150	1/2	11,92
RACG10862610	18	26x150	5/8	24,45
RACG10863012	22	30x200	3/4	28,13
RACG10863616	28	36x200	1"	39,24

**MÉTRICO SERIE PESADA**  
METRIC HEAVY SERIES  
MÉTRIQUE SÉRIE LOURDE



**HEMBRA GIRATORIA SERIE PESADA**  
SWIVEL FEMALE HEAVY SERIES  
FEMELLE TOURNANTE SÉRIE LOURDE

Ref.	∅			€
RACG10911404	6	14x150	1/4	11,55
RACG10911604	8	16x150	1/4	5,67
RACG10911804	10	18x150	1/4	5,67
RACG10911805	10	18x150	5/16	14,54
RACG10911806	10	18x150	3/8	17,94
RACG10912005	12	20x150	5/16	10,46
RACG10912006	12	20x150	3/8	7,40
RACG10912206	14	22x150	3/8	7,48
RACG10912408	16	24x150	1/2	9,40
RACG10913010	20	30x150	5/8	14,85
RACG10913012	20	30x200	3/4	19,26
RACG10913612	25	36x200	3/4	22,92
RACG10913616	25	36x200	1"	38,56
RACG10914216	30	42x200	1"	32,21



**MACHO FIJO MÉTRICO SERIE PESADA**  
METRIC STUD MALE HEAVY SERIES  
MÂLE FIXE MÉTRIQUE SÉRIE LOURDE

Ref.	∅			€
RACG10731604	8	16x150	1/4	6,35
RACG10731804	10	18x150	1/4	5,84
RACG10732005	12	20x150	5/16	8,56
RACG10732006	12	20x150	3/8	6,02
RACG10732206	14	22x150	3/8	6,41
RACG10732408	16	24x150	1/2	7,98
RACG10733010	20	30x200	5/8	19,32
RACG10733612	25	36x200	3/4	20,25
RACG10734216	30	42x200	1"	29,94



**HEMBRA GIRATORIA 90° MÉTRICA SERIE PESADA**  
90° METRIC SWIVEL FEMALE HEAVY SERIES  
FEMELLE TOURNANTE 90° MÉTRIQUE SÉRIE LOURDE

Ref.	∅			€
RACG10951604	8	16x150	1/4	8,54
RACG10951804	10	18x150	1/4	8,54
RACG10952005	12	20x150	5/16	12,61
RACG10952006	12	20x150	3/8	9,81
RACG10952206	14	22x150	3/8	11,98
RACG10952408	16	24x150	1/2	14,59
RACG10953010	20	30x200	5/8	25,19
RACG10953612	25	36x200	3/4	30,11
RACG10954216	30	42x200	1"	42,95



**HEMBRA GIRATORIA 45° MÉTRICA SERIE PESADA**  
45° METRIC SWIVEL FEMALE HEAVY SERIES  
FEMELLE TOURNANTE 45° MÉTRIQUE SÉRIE LOURDE

Ref.	∅			€
RACG10961604	8	16x150	1/4	8,54
RACG10961804	10	18x150	1/4	8,54
RACG10962005	12	20x150	5/16	12,61
RACG10962006	12	20x150	3/8	9,81
RACG10962206	14	22x150	3/8	13,48
RACG10962408	16	24x150	1/2	14,59
RACG10963010	20	30x200	5/8	25,19
RACG10963612	25	36x200	3/4	30,22
RACG10964216	30	42x200	1"	46,65

**SISTEMA ORFS**  
ORFS SYSTEM  
ORFS SYSTEM

**HEMBRA GIRATORIA ORFS**

ORFS SWIVEL FEMALE  
FEMELLE TOURNANTE ORFS



Ref.			€
RACG11110404	9/16	1/4	11,40
RACG11110606	11/16	3/8	12,58
RACG11110806	13/16	3/8	13,90
RACG11110808	13/16	1/2	14,72
RACG11111008	1"	1/2	12,22
RACG11111010	1"	5/8	20,89
RACG11111210	1" 3/16	5/8	38,80
RACG11111212	1" 3/16	3/4	22,59
RACG11111612	1" 7/16	3/4	42,89
RACG11111616	1" 7/16	1"	45,15

**MACHO FIJO ORFS**

ORFS STUD MALE  
MÂLE FIXE ORFS



Ref.			€
RACG11130404	9/16	1/4	26,25
RACG11130606	11/16	3/8	14,21
RACG11130806	13/16	3/8	18,93
RACG11130808	13/16	1/2	15,99
RACG11131008	1"	1/2	23,34
RACG11131010	1"	5/8	26,50
RACG11131210	1" 3/16	5/8	37,85
RACG11131212	1" 3/16	3/4	34,69
RACG11131612	1" 7/16	3/4	40,49
RACG11131616	1" 7/16	1"	44,20

**HEMBRA GIRATORIA 90° ORFS**

90° ORFS SWIVEL FEMALE  
FEMELLE TOURNANTE 90° ORFS



Ref.			€
RACG11150404	9/16	1/4	13,38
RACG11150606	11/16	3/8	14,90
RACG11150806	13/16	3/8	21,91
RACG11150808	13/16	1/2	16,60
RACG11151008	1"	1/2	17,52
RACG11151010	1"	5/8	21,38
RACG11151210	1" 3/16	5/8	48,33
RACG11151212	1" 3/16	3/4	33,31
RACG11151616	1" 7/16	1"	46,81

**HEMBRA GIRATORIA 45° ORFS**

45° ORFS SWIVEL FEMALE  
FEMELLE TOURNANTE 45° ORFS



Ref.			€
RACG11160404	9/16	1/4	13,38
RACG11160606	11/16	3/8	14,90
RACG11160806	13/16	3/8	16,03
RACG11160808	13/16	1/2	16,60
RACG11161008	1"	1/2	44,41
RACG11161010	1"	5/8	21,62
RACG11161210	1" 3/16	5/8	49,18
RACG11161212	1" 3/16	3/4	33,31
RACG11161616	1" 7/16	1"	46,81

**CONEXIONES PRENSAR 4 Y 6 ESPIRALES**  
CRIMPING FITTINGS 4 AND 6 SPIRAL  
CONNEXIONS A SERTIR 4 ET 6 TRESSSES

**CASQUILLOS SISTEMA A3**  
FERRULES A3 SYSTEM  
JUPES SYSTÈME A3

**A3N4 CASQUILLO NO PELAR 4SP/H-R12**  
A3N4 NO-SKIVE FERRULE 4SP/H-R12  
A3N4 JUPE SANS DÉNUDAGE 4SP/H-R12



Ref.	Type	Ø	€
RACA3N412	R12-4SH-R13-R15	3/4"	11,87
RACA3N416	R12-4SH-R13-R15	1"	16,27
RACA3N420	R12-4SH	1" 1/4"	29,03
RACA3N424	R12-4SH	1" 1/2"	48,37
RACA3N432	R12-4SH	2"	77,41

**CASQUILLO A3S6 PRECISA PELADO EXTERNO**  
OUTER SKIVE A3S6 FERRULE  
JUPE A3S6 DÉNUDAJE EXTERNE R13-R15



Ref.	Type	Ø	€
RACA3S620	R13 - R15	1" 1/4"	29,89
RACA3S624	R13 - R15	1" 1/2"	50,04
RACA3S632	R13 - R15	2"	74,50

**CASQUILLO A3N6 NO PRECISA PELADO EXTERNO**  
NO-SKIVE FERRULE R13-R15 A3N6  
JUPE A3N6 SANS DÉNUDAGE EXTERNE R13-R15



Ref.	Type	Ø	€
RACA3N620	R13 - R15	1" 1/4"	35,83
RACA3N624	R13 - R15	1" 1/2"	60,04
RACA3N632	R13 - R15	2"	87,98

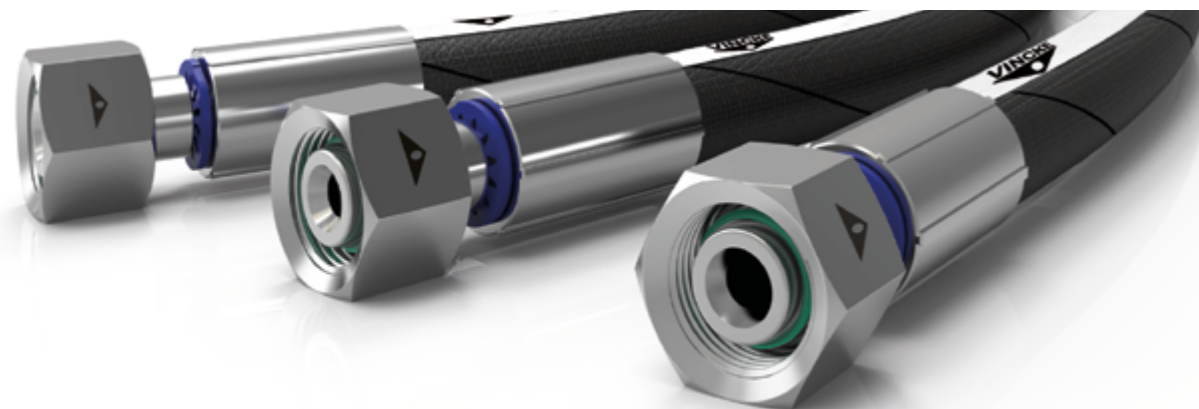

**SISTEMA BSPP**  
BSPP O-RING SYSTEM  
SYSTÈME BSPP O-RING

BS5200 ISO 8434-6 / ISO 12151-6

RECOMENDACIÓN  
RECOMMENDATION  
RECOMMANDATION

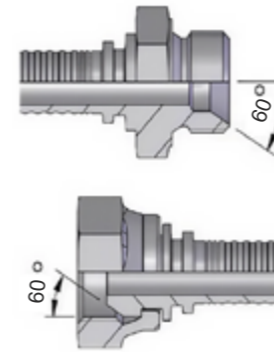

Ø	Torque (Nm)	Working Pressure (bar)
1/8-28	15	420
1/4-19	40	450
3/8-19	45	400
1/2-14	55	400
5/8-14	65	350
3/4-14	85	350
1"-11	135	350
1"1/4-11	175	240
1"1/2-11	240	210
2"-11	300	170

**HEMERA GIRATORIA BSPP O-RING**  
BSPP O-RING SWIVEL FEMALE  
FEMELLE TOURNANTE BSPP O-RING



Ref.	Ø	Ø	€
RACA30111212	3/4"	3/4"	13,88
RACA30111612	1"	3/4"	28,86
RACA30111616	1"	1"	24,43
RACA30112016	1" 1/4"	1"	44,95
RACA30112020	1" 1/4"	1" 1/4"	36,76
RACA30112420	1" 1/2"	1" 1/4"	134,84
RACA30112424	1" 1/2"	1" 1/2"	56,56
RACA30113224	2"	1" 1/2"	112,83
RACA30113232	2"	2"	107,87

**MACHO FIJO BSPP**  
BSPP STUD MALE  
MÂLE FIXE BSPP



Ref.	Ø	Ø	€
RACA30131212	3/4"	3/4"	25,50
RACA30131612	1"	3/4"	43,98
RACA30131616	1"	1"	29,11
RACA30132016	1" 1/4"	1"	79,16
RACA30132020	1" 1/4"	1" 1/4"	46,54
RACA30132420	1" 1/2"	1" 1/4"	130,34
RACA30132424	1" 1/2"	1" 1/2"	65,16
RACA30133232	2"	2"	121,03

**HEMBRA GIRATORIA 90° BSPP O-RING**

90° BSPP SWIVEL FEMALE O-RING  
FEMELLE TOURNANTE 90° BSPP O-RING



Ref.			€
RACA30151212	3/4	3/4	26,02
RACA30151612	1"	3/4	69,34
RACA30151616	1"	1"	41,61
RACA30152016	1" 1/4	1"	109,20
RACA30152020	1" 1/4	1" 1/4	63,28
RACA30152420	1" 1/2	1" 1/4	190,69
RACA30152424	1" 1/2	1" 1/2	104,02
RACA30153224	2"	1" 1/2	186,37
RACA30153232	2"	2"	186,37

**HEMBRA GIRATORIA 45° BSPP O-RING**

45° BSPP O-RING SWIVEL FEMALE  
FEMELLE TOURNANTE 45° BSPP O-RING



Ref.			€
RACA30161212	3/4	3/4	28,76
RACA30161612	1"	3/4	94,38
RACA30161616	1"	1"	46,84
RACA30162016	1" 1/4	1"	116,85
RACA30162020	1" 1/4	1" 1/4	71,91
RACA30162420	1" 1/2	1" 1/4	179,78
RACA30162424	1" 1/2	1" 1/2	104,28
RACA30163232	2"	2"	186,17

**MACHO FIJO NPTF**

NPTF STUD MALE  
MÂLE FIXE NPTF



Ref.			€
RACA30231212	3/4	3/4	29,88
RACA30231616	1"	1"	37,35
RACA30232020	1" 1/4	1" 1/4	52,66
RACA30232424	1" 1/2	1" 1/2	67,47
RACA30233232	2"	2"	120,89

**MACHO FIJO BSPT**

BSPT STUD MALE  
MÂLE FIXE BSPT



Ref.			€
RACA30331212	3/4	3/4	29,88
RACA30331616	1"	1"	37,35
RACA30332020	1" 1/4	1" 1/4	52,66
RACA30332424	1" 1/2	1" 1/2	67,47
RACA30333232	2"	2"	120,89

**RECOMENDACIÓN**  
RECOMMENDATION  
RECOMMENDATION

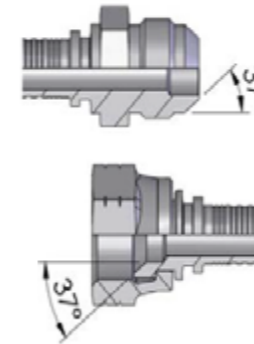

		Working Pressure (bar)
7/16-20	20	350
1/2-20	32	350
9/16-18	40	350
3/4-16	55	310
7/8-14	70	240
1"1/16-12	105	240
1"5/16-12	160	210
1"5/8-12	170	170
1"7/8-12	200	140

ISO 8434-2 / SAE J514 / ISO 12151-5

**HEMBRA GIRATORIA SAE JIC**

SAE JIC SWIVEL FEMALE  
FEMELLE TOURNANTE SAE JIC

Ref.			€
RACA30411212	1" 1/16	3/4	15,28
RACA30411612	1" 5/16	3/4	33,32
RACA30411616	1" 5/16	1"	24,27
RACA30412016	1" 5/8	1"	76,40

Ref.			€
RACA30412020	1" 5/8	1" 1/4	38,65
RACA30412420	1" 7/8	1" 1/4	103,38
RACA30412424	1" 7/8	1" 1/2	67,42
RACA30413232	2" 1/2	2"	116,85

**MACHO FIJO SAE JIC**

SAE JIC STUD MALE  
MÂLE FIXE SAE JIC

Ref.			€
RACA30431212	1" 1/16	3/4	17,98
RACA30431612	1" 5/16	3/4	46,74
RACA30431616	1" 5/16	1"	25,64

Ref.			€
RACA30432016	1" 5/8	1"	81,28
RACA30432020	1" 5/8	1" 1/4	53,93
RACA30432424	1" 7/8	1" 1/2	95,71

**HEMBRA GIRATORIA 90° SAE JIC**

90° SAE JIC SWIVEL FEMALE  
FEMELLE TOURNANTE 90° SAE JIC

Ref.			€
RACA30451212	1" 1/16	3/4	26,96
RACA30451612	1" 5/16	3/4	67,42
RACA30451616	1" 5/16	1"	44,95
RACA30452016	1" 5/8	1"	98,88

Ref.			€
RACA30452020	1" 5/8	1" 1/4	71,91
RACA30452420	1" 7/8	1" 1/4	296,64
RACA30452424	1" 7/8	1" 1/2	27,95

**HEMBRA GIRATORIA 45° SAE JIC**

45° SAE JIC SWIVEL FEMALE  
FEMELLE TOURNANTE 45° SAE JIC

Ref.			€
RACA30461212	1" 1/16	3/4	35,96
RACA30461612	1" 5/16	3/4	71,91
RACA30461616	1" 5/16	1"	53,48
RACA30462016	1" 5/8	1"	116,85

Ref.			€
RACA30462020	1" 5/8	1" 1/4	78,48
RACA30462424	1" 7/8	1" 1/2	127,65
RACA30463232	2" 1/2	2"	252,58

**MÉTRICO SERIE PESADA**  
METRIC HEAVY SERIES  
MÉTRIQUE SÉRIE LOURDE

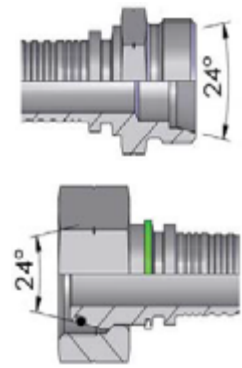

**ISO 8434-1 / DIN 3865 / ISO 12151-2**

		(Nm)	Working Pressure (Nm)
	14x1,5	30	630
	16x1,5	35	630
	18x1,5	50	630
	20x1,5	60	630
	22x1,5	70	630
	24x1,5	80	400
	30x2	130	400
	36x2	190	315
	42x2	260	315
	52x2	270	315

RECOMENDACIÓN  
RECOMMENDATION  
RECOMMENDATION

**HEMBRA GIRATORIA MÉTRICA SERIE PESADA O-RING**  
METRIC SWIVEL FEMALE O-RING HEAVY SERIES  
FEMELLE TOURNANTE MÉTRIQUE SÉRIE LOURDE O-RING



Ref.	∅			€
RACA30913012	20	30x200	3/4	30,46
RACA30913612	25	36x200	3/4	22,75
RACA30913616	25	36x200	1"	50,30
RACA30914216	30	42x200	1"	29,83

Ref.	∅			€
RACA30914220	30	42x200	1" 1/4	89,65
RACA30915220	38	52x200	1" 1/4	49,52
RACA30915224	38	52x200	1" 1/2	130,34

**MACHO FIJO MÉTRICO SERIE PESADA O-RING**  
METRIC STUD MALE O-RING HEAVY SERIES  
MÂLE FIXE MÉTRIQUE SÉRIE LOURDE O-RING



Ref.	∅			€
RACA30933012	20	30x200	3/4	34,16
RACA30933612	25	36x200	3/4	19,76
RACA30933616	25	36x200	1"	53,93
RACA30934216	30	42x200	1"	31,47

Ref.	∅			€
RACA30934220	30	42x200	1" 1/4	71,91
RACA30935220	38	52x200	1" 1/4	53,93
RACA30935224	38	52x200	1" 1/2	89,88

**HEMBRA GIRATORIA 90° SERIE PESADA O-RING**  
90° SWIVEL FEMALE O-RING HEAVY SERIES  
FEMELLE TOURNANTE 90° SÉRIE LOURDE O-RING



Ref.	∅			€
RACA30953012	20	30x200	3/4	44,95
RACA30953612	25	36x200	3/4	44,95
RACA30953616	25	36x200	1"	70,98
RACA30954216	30	42x200	1"	49,43

Ref.	∅			€
RACA30954220	30	42x200	1" 1/4	134,84
RACA30955220	38	52x200	1" 1/4	75,51
RACA30955224	38	52x200	1" 1/2	215,73

**HEMBRA GIRATORIA 45° SERIE PESADA O-RING**  
45° SWIVEL FEMALE O-RING HEAVY SERIES  
FEMELLE TOURNANTE 45° SÉRIE LOURDE O-RING



Ref.	∅			€
RACA30963012	20	30x200	3/4	44,95
RACA30963612	25	36x200	3/4	49,44
RACA30963616	25	36x200	1"	76,40
RACA30964216	30	42x200	1"	58,41

Ref.	∅			€
RACA30964220	30	42x200	1" 1/4	152,82
RACA30965220	38	52x200	1" 1/4	83,13
RACA30965224	38	52x200	1" 1/2	215,72

RECOMENDACIÓN  
RECOMMENDATION  
RECOMMENDATION

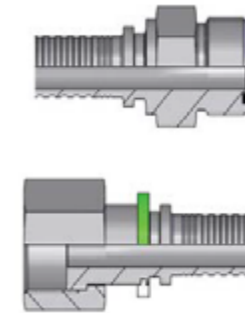

**ISO 8434-3 / SAE J1453 9 ISO 12151-1**

		(Nm)	Working Pressure (bar)
	9/16-18	40	450
	11/16-16	70	450
	13/16-16	80	420
	1"-14	100	420
	1"3/16-12	130	420
	1"7/16-12	170	420
	1"11/16-12	200	350
	2"-12	260	275

**HEMBRA GIRATORIA ORFS**  
ORFS SWIVEL FEMALE  
FEMELLE TOURNANTE ORFS

Ref.			€
RACA31111012	1"	3/4	44,77
RACA31111212	1" 3/16	3/4	22,17
RACA31111612	1" 7/16	3/4	62,90
RACA31111616	1" 7/16	1"	40,46

Ref.			€
RACA31112016	1" 11/16	1"	94,91
RACA31112020	1" 11/16	1" 1/4	50,34
RACA31112424	2"	1" 1/2	94,29

**MACHO FIJO ORFS**  
ORFS STUD MALE  
MÂLE FIXE ORFS

Ref.			€
RACA31131212	1" 3/16	3/4	44,20
RACA31131612	1" 7/16	3/4	47,29
RACA31131616	1" 7/16	1"	47,29
RACA31132016	1" 11/16	1"	65,28

Ref.			€
RACA31132020	1" 11/16	1" 1/4	65,29
RACA31132420	2"	1" 1/4	141,94
RACA31132424	2"	1" 1/2	141,94

**HEMBRA GIRATORIA 90° ORFS**  
90° ORFS SWIVEL FEMALE  
FEMELLE TOURNANTE 90° ORFS

Ref.			€
RACA31151212	1" 3/16	3/4	40,90
RACA31151612	1" 7/16	3/4	75,86
RACA31151616	1" 7/16	1"	58,41
RACA31152016	1" 11/16	1"	89,53

Ref.			€
RACA31152020	1" 11/16	1" 1/4	85,40
RACA31152020-L155	1" 11/16	1" 1/4	106,61
RACA31152424	2"	1" 1/2	152,82

**HEMBRA GIRATORIA 45° ORFS**  
45° ORFS SWIVEL FEMALE  
FEMELLE TOURNANTE 45° ORFS

Ref.			€
RACA31161212	1" 3/16	3/4	38,74
RACA31161612	1" 7/16	3/4	158,16
RACA31161616	1" 7/16	1"	58,41

Ref.			€
RACA31162016	1" 11/16	1"	89,53
RACA31162020	1" 11/16	1" 1/4	83,24

**BRIDAS SAE ISO 6162-1/2**  
6162-1/2 SAE FLANGES  
BRIDE SAE 6162-1/2

**BRIDA RECTA S3000 PSI**  
S3000 PSI STRAIGHT FLANGE  
BRIDE DROITE S3000 PSI



Ref.	Ø			€
RACA31341212	38,1	3/4	3/4	22,23
RACA31341216	38,1	3/4	1"	89,88
RACA31341612	44,5	1"	3/4	34,16
RACA31341616	44,5	1"	1"	29,89
RACA31341620	44,5	1"	1" 1/4	45,63
RACA31342016	50,8	1" 1/4	1"	45,95
RACA31342020	50,8	1" 1/4	1" 1/4	42,69
RACA31342420	60,3	1" 1/2	1" 1/4	76,86
RACA31342424	60,3	1" 1/2	1" 1/2	59,80
RACA31343224	71,4	2"	1" 1/2	106,73
RACA31343232	71,4	2"	2"	97,95

**BRIDA 90° S3000 PSI**  
90° S3000 PSI FLANGE  
BRIDE 90° S3000 PSI



Ref.	Ø			€
RACA31351212	38,1	3/4	3/4	35,86
RACA31351216	38,1	3/4	1"	98,88
RACA31351612	44,5	1"	3/4	51,24
RACA31351616	44,5	1"	1"	46,96
RACA31351620	44,5	1"	1" 1/4	75,45
RACA31352016	50,8	1" 1/4	1"	74,29
RACA31352020	50,8	1" 1/4	1" 1/4	66,61
RACA31352420	60,3	1" 1/2	1" 1/4	98,88
RACA31352424	60,3	1" 1/2	1" 1/2	107,87
RACA31353224	71,4	2"	1" 1/2	179,78
RACA31353232	71,4	2"	2"	179,78

**BRIDA 90° S3000 PSI LARGA**  
90° S3000 PSI FLANGE LONG DROP  
BRIDE 90° S3000 PSI LONGUE



Ref.	Ø	Long.			€
RACA31351212-L120	38,1	120	3/4	3/4	45,57
RACA31351612-L120	44,5	120	1"	3/4	52,40
RACA31351616-L140	44,5	140	1"	1"	52,40
RACA31352016-L140	50,8	140	1" 1/4	1"	90,00
RACA31352020-L160	50,8	160	1" 1/4	1" 1/4	90,00

**BRIDA 45° S3000 PSI**  
45° S3000 PSI FLANGE  
BRIDE 45° S3000 PSI



Ref.	Ø			€
RACA31361212	38,1	3/4	3/4	38,42
RACA31361216	38,1	3/4	1"	80,89
RACA31361612	44,5	1"	3/4	46,96
RACA31361616	44,5	1"	1"	46,96
RACA31362016	50,8	1" 1/4	1"	70,98
RACA31362020	50,8	1" 1/4	1" 1/4	72,58
RACA31362420	60,3	1" 1/2	1" 1/4	103,38
RACA31362424	60,3	1" 1/2	1" 1/2	107,87
RACA31363224	71,4	2"	1" 1/2	179,78
RACA31363232	71,4	2"	2"	181,85

**BRIDA 135° S3000 PSI**  
135° S3000 PSI FLANGE  
BRIDE 135° S3000 PSI



Ref.	Ø			€
RACA31311212	38,1	3/4	3/4	50,20
RACA31311616	44,5	1"	1"	138,44
RACA31312020	50,8	1" 1/4	1" 1/4	142,83
RACA31312424	60,3	1" 1/2	1" 1/2	150,63
RACA31313232	71,4	2"	2"	251,70

**BRIDA 22,5° S3000 PSI**  
22,5° S3000 PSI FLANGE  
BRIDE 22,5° S3000 PSI



Ref.	Ø			€
RACA31321212	38,1	3/4	3/4	50,20
RACA31321616	44,5	1"	1"	138,44
RACA31322020	50,8	1" 1/4	1" 1/4	93,24
RACA31322424	60,3	1" 1/2	1" 1/2	150,63
RACA31323232	71,4	2"	2"	251,70

**BRIDA 30° S3000 PSI**  
30° S3000 PSI FLANGE  
BRIDE 30° S3000 PSI



Ref.	Ø			€
RACA31331212	38,1	3/4	3/4	50,20
RACA31331616	44,5	1"	1"	138,44
RACA31332020	50,8	1" 1/4	1" 1/4	93,24
RACA31332424	60,3	1" 1/2	1" 1/2	150,63
RACA31333232	71,4	2"	2"	251,70

**BRIDA 67,5° S3000 PSI**

67,5° S3000 PSI FLANGE  
BRIDE 67,5° S3000 PSI



Ref.	∅			€
RACA31381212	38,1	3/4	3/4	50,20
RACA31381616	44,5	1"	1"	138,44
RACA31382020	50,8	1" 1/4	1" 1/4	93,24
RACA31382424	60,3	1" 1/2	1" 1/2	150,63
RACA31383232	71,4	2"	2"	251,70

**BRIDA RECTA S6000 PSI**

S6000 PSI STRAIGHT FLANGE  
BRIDE DROITE S6000 PSI



Ref.	∅			€
RACA31441212	41,3	3/4	3/4	26,64
RACA31441216	41,3	3/4	1"	55,86
RACA31441612	47,6	1"	3/4	45,38
RACA31441616	47,6	1"	1"	34,20
RACA31441620	47,6	1"	1" 1/4	68,35
RACA31442016	54	1" 1/4	1"	54,33
RACA31442020	54	1" 1/4	1" 1/4	43,36
RACA31442420	63,5	1" 1/2	1" 1/4	91,02
RACA31442424	63,5	1" 1/2	1" 1/2	69,36
RACA31443224	79,4	2"	1" 1/2	161,03
RACA31443232	79,4	2"	2"	161,03

**BRIDA 90° S6000 PSI**

90° S6000 PSI FLANGE  
BRIDE 90° S6000 PSI



Ref.	∅			€
RACA31451212	41,3	3/4	3/4	49,55
RACA31451216	41,3	3/4	1"	92,90
RACA31451612	47,6	1"	3/4	53,26
RACA31451616	47,6	1"	1"	45,83
RACA31451620	47,6	1"	1" 1/4	93,24
RACA31452016	54	1" 1/4	1"	72,20
RACA31452020	54	1" 1/4	1" 1/4	70,76
RACA31452420	63,5	1" 1/2	1" 1/4	121,03
RACA31452424	63,5	1" 1/2	1" 1/2	121,01
RACA31453224	79,4	2"	1" 1/2	248,96
RACA31453232	79,4	2"	2"	248,96

**BRIDA 90° S6000 PSI LARGA**

90° S6000 PSI FLANGE LONG DROP  
BRIDE 90° S6000 PSI LONGUE



Ref.	∅	Long.			€
RACA31451212-L120	41,3	120	3/4	3/4	55,25
RACA31451612-L120	47,6	120	1"	3/4	62,66
RACA31451616-L140	47,6	140	1"	1"	62,66
RACA31452016-L140	54	140	1" 1/4	1"	95,70
RACA31452020-L160	54	160	1" 1/4	1" 1/4	95,70

**BRIDA 45° S6000 PSI**

45° S6000 PSI FLANGE  
BRIDE 45° S6000 PSI



Ref.	∅			€
RACA31461212	41,3	3/4	3/4	47,84
RACA31461216	41,3	3/4	1"	88,59
RACA31461612	47,6	1"	3/4	54,95
RACA31461616	47,6	1"	1"	53,15
RACA31462016	54	1" 1/4	1"	75,36
RACA31462020	54	1" 1/4	1" 1/4	83,30
RACA31462420	63,5	1" 1/2	1" 1/4	123,59
RACA31462424	63,5	1" 1/2	1" 1/2	124,04
RACA31463224	79,4	2"	1" 1/2	230,37
RACA31463232	79,4	2"	2"	248,10

**BRIDA 135° S6000 PSI**

135° S6000 PSI FLANGE  
135° S6000 PSI BRIDE



Ref.	∅			€
RACA31411212	41,3	3/4	3/4	55,22
RACA31411616	47,6	1"	1"	152,29
RACA31412020	54	1" 1/4	1" 1/4	102,57
RACA31412424	63,5	1" 1/2	1" 1/2	165,70
RACA31413232	79,4	2"	2"	276,87

**BRIDA 22,5° S6000 PSI**

22,5° S6000 PSI FLANGE  
22,5° S6000 PSI BRIDE



Ref.	∅			€
RACA31421212	41,3	3/4	3/4	55,22
RACA31421616	47,6	1"	1"	152,29
RACA31422020	54	1" 1/4	1" 1/4	102,57
RACA31422424	63,5	1" 1/2	1" 1/2	165,70
RACA31423232	79,4	2"	2"	276,87

**BRIDA 30° S6000 PSI**  
30° S6000 PSI FLANGE  
30° S6000 PSI BRIDE



Ref.	∅			€
RACA31431212	41,3	3/4	3/4	55,22
RACA31431616	47,6	1"	1"	152,29
RACA31432020	54	1" 1/4	1" 1/4	102,57
RACA31432424	63,5	1" 1/2	1" 1/2	165,70
RACA31433232	79,4	2"	2"	276,87

**BRIDA 67,5° S6000 PSI**  
67,5° S6000 PSI FLANGE  
67,5° S6000 PSI BRIDE



Ref.	∅			€
RACA31481212	41,3	3/4	3/4	55,22
RACA31481616	47,6	1"	1"	152,29
RACA31482020	54	1" 1/4	1" 1/4	102,57
RACA31482424	63,5	1" 1/2	1" 1/2	165,70
RACA31483232	79,4	2"	2"	276,87

**BRIDA SUPERCAT S9000 PSI**  
S9000 PSI SUPERCAT FLANGE  
BRIDE SUPERCAT S9000 PSI



Ref.	∅			€
RACA31641212	41,3	3/4	3/4	44,19
RACA31641612	47,6	1"	3/4	63,77
RACA31641616	47,6	1"	1"	50,78
RACA31642016	54	1" 1/4	1"	69,56
RACA31642020	54	1" 1/4	1" 1/4	69,66
RACA31642420	63,5	1" 1/2	1" 1/4	126,22
RACA31642424	63,5	1" 1/2	1" 1/2	123,14
RACA31643232	79,4	2"	2"	215,73

**BRIDA SUPERCAT 90° S9000 PSI**  
90° S9000 PSI SUPERCAT FLANGE  
BRIDE SUPERCAT 90° S9000 PSI



Ref.	∅			€
RACA31651212	41,3	3/4	3/4	65,70
RACA31651612	47,6	1"	3/4	58,21
RACA31651616	47,6	1"	1"	68,30
RACA31652016	54	1" 1/4	1"	94,44
RACA31652020	54	1" 1/4	1" 1/4	98,88
RACA31652424	63,5	1" 1/2	1" 1/2	137,81
RACA31653232	79,4	2"	2"	278,64

**BRIDA SUPERCAT 45° S9000 PSI**  
45° S9000 PSI SUPERCAT FLANGE  
BRIDE SUPERCAT 45° S9000 PSI



Ref.	∅			€
RACA31661212	41,3	3/4	3/4	65,70
RACA31661612	41,3	1"	3/4	58,21
RACA31661616	47,6	1"	1"	70,17
RACA31662016	54	1" 1/4	1"	94,44
RACA31662020	54	1" 1/4	1" 1/4	93,67
RACA31662424	63,5	1" 1/2	1" 1/2	123,14

**JUNTAS BRIDA SAE**  
SAE FLANGE SEALS  
JOINTS BRIDE SAE

**JUNTA BRIDA CAT 9000 PSI**  
CAT 9000 PSI O-RING FLANGE  
JOINT BRIDE CAT 9000 PSI



Ref.		€
RACORCAT12	3/4	8,38
RACORCAT16	1"	10,88
RACORCAT20	1" 1/4	12,94
RACORCAT24	1" 1/2	14,03
RACORCAT32	2"	18,14

**JUNTA VITÓN O-RING**  
VITON O-RING  
JOINT VITON



Ref.	∅	€
RACOR3608	1/2	1,87
RACOR3612	3/4	2,29
RACOR3616	1"	2,88
RACOR3620	1" 1/4	3,23
RACOR3624	1" 1/2	3,98
RACOR3632	2"	5,04

**CONEXIONES PRENSAR VIN-BLAST**  
CRIMPING FITTINGS VIN-BLAST  
CONNEXIONS A SERTIR VIN-BLAST

**CASQUILLO VIN-BLAST**  
VIN-BLAST FERRULE  
JUPE VIN-BLAST



Ref.		€
RAPBLAS000008	1/2	14,89
RAPBLAS000012	3/4	19,17

**HEMBRA GIRATORIA BSPP O-RING VIN-BLAST**  
VIN-BLAST BSPP O-RING SWIVEL FEMALE  
FEMELLE TOURNANTE BSPP O-RING VIN-BLAST



Ref.			€
RAPBLAS110808	1/2	1/2	14,98
RAPBLAS111212	3/4	3/4	18,86

**HEMBRA GIRATORIA MÉTRICA SERIE PESADA VIN-BLAST 1100 BAR**  
VIN-BLAST 1100 BARS METRIC SWIVEL FEMALE HEAVY SERIES  
FEMELLE TOURNANTE MÉTRIQUE SÉRIE LOURDE VIN-BLAST 1100 BARS



Ref.	∅			€
RAPBLAS912408	16	24x150	1/2	15,73
RAPBLAS913012	20	30x200	3/4	19,62
RAPBLAS913612	25	36x200	3/4	21,55

**CONEXIONES PRENSAR JACK HOSE 700 BAR**  
CRIMPING FITTINGS JACK HOSE 700 BAR  
CONNEXIONS A SERTIR JACK HOSE 700 BAR

**CASQUILLO 700 BAR**  
700 BAR JACK HOSE FERRULE  
JUPE 700 BAR

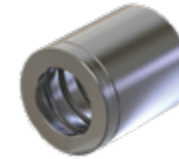

Ref.		€
RAP700000004	1/4	8,19

**RACORD 700 BAR JACK HOSE**  
700 BAR JACK HOSE FITTINGS  
RACCORD ++700 BAR JACK HOSE



Ref.	∅			€
RAP710110404		1/4	1/4	15,22
RAP710130404		1/4	1/4	16,96
RAP710230404		1/4	1/4	20,03
RAP710230604		3/8	1/4	20,95
RAP710410404		7/16	1/4	30,53
RAP710410604		9/16	1/4	27,49
RAP710911604	8	16x150	1/4	20,30
RAP710911804	10	18x150	1/4	30,49





# TODO EN HIDRÁULICA EVERYTHING IN HYDRAULICS TOUTE L'HYDRAULIQUE



**Expertos en distribución. Enviando cada día +1.500 líneas de pedido. Trabajamos con más de 50 países. Envíos en 24 horas.**

Specialists in the distribution of connections and hydraulic components. We dispatch over 1.500 order lines daily and work with over 50 countries. Offering shipping within 24 hours.

*Spécialistes de la distribution de connectique et composants hydrauliques. Expédition quotidienne de +1 500 lignes de commandes. Nous travaillons avec plus de 50 pays. Expédition sous 24 heures.*



# UTILIZA NUESTRA TIENDA ONLINE USE OUR ONLINE STORE UTILISEZ NOTRE BOUTIQUE EN LIGNE

- PRÁCTICA Y RÁPIDA.
- PRIORIZAMOS TUS PEDIDOS.
- PUEDES VER NUESTRO STOCK.
- PUEDES VER TU PRECIO ACTUALIZADO.
- PUEDES VER LA SITUACIÓN DEL PEDIDO.
- ENTRA EN EL CONCURSO MENSUAL PARA GANAR UN CUPÓN REGALO.

- PRACTICAL AND FAST.
- WE PRIORITIZE YOUR ORDERS.
- YOU CAN CHECK OUR STOCK.
- YOU CAN SEE YOUR UPDATED PRICE.
- YOU CAN TRACK THE ORDER STATUS.
- ENTER THE MONTHLY CONTEST TO WIN A GIFT VOUCHER.

- PRATIQUE ET RAPIDE.
- NOUS PRIORISONS VOS COMMANDES.
- VOUS POUVEZ CONSULTER NOTRE STOCK.
- VOUS POUVEZ VOIR VOTRE PRIX ACTUALISÉ.
- VOUS POUVEZ SUIVRE L'ETAT DE LA COMMANDE.
- PARTICIPEZ AU CONCOURS MENSUEL POUR GAGNER UN BON DE REDUCTION.

[www.vinckehydraulics.com](http://www.vinckehydraulics.com)

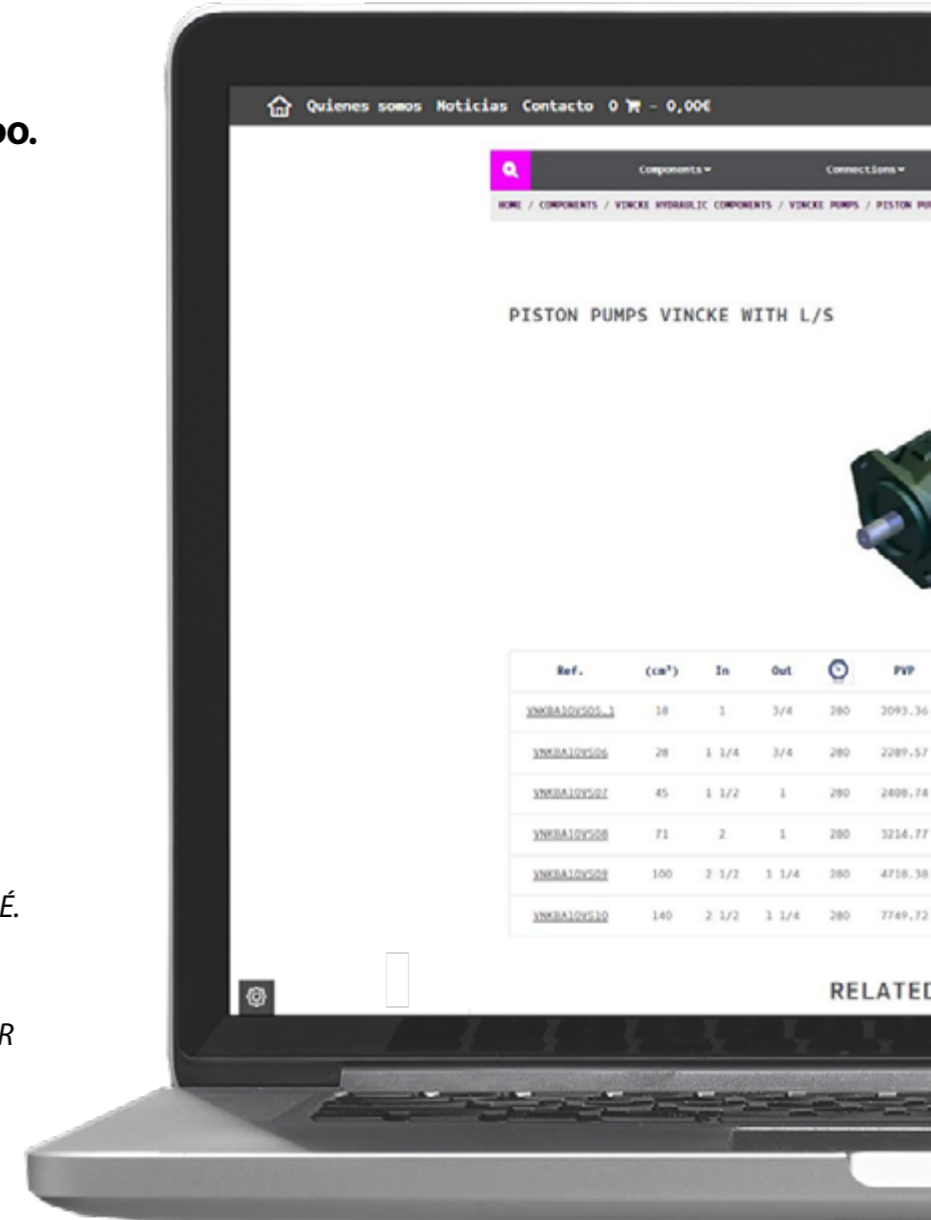

**RACORD TERMOPLÁSTICA ALCANTARILLADO SJ-8**  
SJ-8 SEWER JET THERMOPLASTIC FITTINGS  
RACCORD SJ-8 NETTOYAGE THERMOPLASTIC

**CASQUILLO SJ-8**  
SJ-8 FERRULE  
JUPE SJ-8



Ref.		€
RAPSJ00000008	1/2	7,57
RAPSJ00000012	3/4	14,16
RAPSJ00000016	1"	17,86

**HEMBRA GIRATORIA BSPP SJ-8**  
SJ-8 BSPP SWIVEL FEMALE  
FEMELLE TOURNANTE BSPP SJ-8

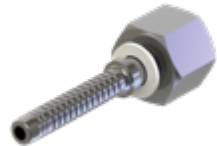

Ref.		€
RAPSJ10110808	1/2	9,33
RAPSJ10111212	3/4	18,74
RAPSJ10111616	1"	29,30

**MACHO BSPP SJ-8**  
SJ-8 BSPP MALE  
MÂLE BSPP SJ-8

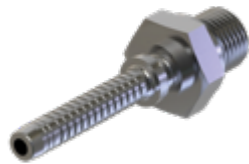

Ref.		€
RAPSJ10130808	1/2	8,18
RAPSJ10131212	3/4	12,23
RAPSJ10131616	1"	17,95

**MACHO NPTF SJ-8**  
SJ-8 NPTF MALE  
MÂLE NPTF SJ-8



Ref.		€
RAPSJ10330808	1/2	8,88
RAPSJ10331212	3/4	13,81
RAPSJ10331616	1"	20,23

**CONEXIONES PRENSAR DE CONTROL DE PRESIÓN**  
CRIMPING FITTINGS PRESSURE CONTROL  
CONNEXIONS A SERTIR DE CONTRÔLE PRESSION

**HEMBRA GIRATORIA BSPP 60°**  
60° BSPP SWIVEL FEMALE  
FEMELLE TOURNANTE BSPP 60°



Ref.		€
RACMH110002	1/8 BSPP	9,59
RACMH110004	1/4 BSPP	10,14

**HEMBRA GIRATORIA BSPP PARA MANÓMETRO**  
BSPP SWIVEL FEMALE FOR PRESSURE GAUGE PLUG-IN CONNECT.  
FEMELLE TOURNANTE BSPP MANOMÈTRE



Ref.		€
RACMH120004	1/4 BSPP	9,05
RACMH120008	1/2 BSPP	26,91

**HEMBRA GIRATORIA TOMA PRESIÓN**  
SWIVEL FEMALE PRESSURE CONNECTION  
FEMELLE TOURNANTE PRISE PRESSION



Ref.		€
RACMH131615	16x150	12,41
RACMH131620	16x200	9,98

**TOMA BAYONETA**  
PLUG-IN CONNECTION  
PRISE BAÏONNETTE



Ref.	€
RACMH140000	9,11

**HEMBRA GIRATORIA CONO 24°**  
24° CONE SWIVEL FEMALE  
FEMELLE TOURNANTE CÔNE 24°



Ref.		€
RACMH150012	12x150	9,16
RACMH150014	14x150	10,08



**ESPIGA LISA RECTA**  
STRAIGHT STANDPIPE  
EMBOUT LISSE DROIT

Ref.	Ø	€
RACMH160006	6	5,95
RACMH160008	8	7,88



**MACHO FIJO**  
STUD MALE  
MÂLE FIXE

Ref.	Ø	€
RACMH680002	1/8 BSPP	10,90
RACMH880002	1/8 NPTF	11,98



**HEMBRA GIRATORIA SAE**  
SAE SWIVEL FEMALE  
FEMELLE TOURNANTE SAE

Ref.	Ø	€
RACMH770004	7/16	10,14



**ESPIGA LISA 90°**  
90° STANDPIPE  
EMBOUT LISSE 90°

Ref.	Ø	€
RACMH440006	6	23,01



**ADAPTADOR MANÓMETRO TOMA PASATABIQUES**  
PRESSURE GAUGE ADAPTER BULKHEAD CONNECTION  
ADAPTATEUR MANOMÈTRE PRISE PASSE-CLOISON

Ref.	Ø	Ø	€
RACMH171604	16x200	1/4	24,44
RACMH171608	16x200	1/2	44,35



**ADAPTADOR MANÓMETRO TOMA PRESIÓN HEMBRA**  
PRESSURE GAUGE ADAPTER FEMALE PRESSURE CONNECTION  
ADAPTATEUR MANOMÈTRE PRISE PRESSION FEMELLE

Ref.	Ø	Ø	€
RACMH181604	16x200	1/4	24,84
RACMH181608	16x200	1/2	40,53



**ADAPTADOR MANÓMETRO TOMA PRESIÓN 90°**  
90° PRESSURE GAUGE CONNECTION ADAPTER  
ADAPTATEUR MANOMÈTRE PRISE PRESSION 90°

Ref.	Ø	Ø	€
RACMH251604	16x200	1/4	34,84
RACMH251608	16x200	1/2	40,53



**ADAPTADOR TOMA PRESIÓN HEMBRA GIRATORIA MÉTRICA**  
METRIC SWIVEL FEMALE PRESSURE CONNECTION ADAPTER  
ADAPTATEUR PRISE PRESSION FEMELLE TOURNANTE MÉTRIQUE

Ref.	Ø	Ø	€
RACMH280014	8	16X200	22,18
RACMH220019	10	16X200	26,00
RACMH220018	12	16X200	26,00
RACMH280022	15	16X200	27,11
RACMH220020	22	16X200	43,12
RACMH220021	12	16X200	29,14
RACMH220022	16	16X200	36,87
RACMH220023	20	16X200	44,00



**ADAPTADOR TOMA PRESIÓN MACHO BSPP**  
BSPP MALE PRESSURE CONNECTION ADAPTER  
ADAPTATEUR PRISE PRESSION MÂLE BSPP

Ref.	Ø	Ø	€
RACMH231602	1/8	16X200	17,39
RACMH231604	1/4	16X200	14,87
RACMH191606	3/8	16X200	23,18
RACMH191608	1/2	16X200	30,97



**ADAPTADOR TOMA PRESIÓN MACHO BSPT**  
BSPT MALE PRESSURE CONNECTION ADAPTER  
ADAPTATEUR PRISE PRESSION MÂLE BSPT

Ref.	Ø	Ø	€
RACMH201602	1/8	16X200	17,39
RACMH201604	1/4	16X200	17,39
RACMH201606	3/8	16X200	23,79

**ADAPTADOR TOMA PRESIÓN MACHO NPTF**

PTF MALE PRESSURE CONNECTION ADAPTER  
ADAPTATEUR PRISE PRESSION MÂLE NPTF



Ref.			€
RACMH211602	1/8	16X200	17,39
RACMH211604	1/4	16X200	17,39
RACMH211606	3/8	16X200	23,79

**ADAPTADOR TOMA PRESIÓN MACHO MÉTRICO**

METRIC MALE PRESSURE CONNECTION ADAPTER  
ADAPTATEUR PRISE PRESSION MÂLE MÉTRIQUE



Ref.			€
RACMH231608	8x100	16X200	17,39
RACMH231610	10x100	16X200	17,39
RACMH231612	12x150	16X200	17,39
RACMH231614	14x150	16X200	17,39
RACMH231616	16x150	16X200	20,72

**ADAPTADOR TOMA PRESIÓN MACHO UNF**

UNF MALE PRESSURE CONNECTION ADAPTER  
ADAPTATEUR PRISE PRESSION MÂLE UNF



Ref.			€
RACMH221604	7/16	16X200	17,39
RACMH221605	1/2	16X200	21,03
RACMH221606	9/16	16X200	17,39
RACMH221608	3/4	16X200	24,35

**ADAPTADOR TOMA PRESIÓN BAYONETA**

PLUG-IN PRESSURE CONNECTION ADAPTER  
ADAPTATEUR PRISE PRESSION BAÏONNETTE



Ref.			€
RACMH240100	10x100		10,45
RACMH240800	8x100		10,45
RACMH240002	1/8		10,45
RACMH240004	1/4		21,57
RACMH240006	3/8		24,57
RACMH240008	1/2		32,55



**CAMPANAS DE PRENSAR**

CRIMPING FERRULES  
JUPES À SERTIR

Ref.	Ø	€
RAC082000010	10	0,46
RAC082000011	11	0,47
RAC082000012	12	0,49
RAC082000013	13	0,49
RAC082000014	14	0,50
RAC082000015	15	0,51
RAC082000016	16	0,55
RAC082000017	17	0,69
RAC082000018	18	0,70
RAC082000019	19	0,75
RAC082000020	20	0,81
RAC082000021	21	0,87
RAC082000022	22	1,05
RAC082000023	23	1,13
RAC082000024	24	1,19
RAC082000025	25	1,33
RAC082000026	26	1,33

**CONEXIONES PRENSAR DE BAJA PRESIÓN**

CRIMPING FITTINGS LOW PRESSURE  
CONNEXIONS A SERTIR BASSE PRESSION

Ref.	Ø	€
RAC082000027	27	1,40
RAC082000028	28	1,45
RAC082000029	29	1,57
RAC082000030	30	1,75
RAC082000031	31	1,87
RAC082000033	33	1,87
RAC082000035	35	1,91
RAC082000036	36	2,28
RAC082000039	39	2,17
RAC082000041	41	4,87
RAC082000046	46	5,75
RAC082000051	51	7,21
RAC082000056	56	8,64
RAC082000061	61	10,11
RAC082000066	66	11,45
RAC082000071	71	11,82

**TUERCA BSPP (BAJA PRESIÓN)**

BSPP NUT (LOW PRESSURE)  
ÉCROU BSPP (BASSE PRESSION)



Ref.		€
RAC080100207	1/8	1,12
RAC080100409	1/4	1,60
RAC080100612	3/8	3,88
RAC080100613	3/8	1,52
RAC080100816	1/2	3,56

Ref.		€
RAC080101221	3/4	11,90
RAC080101626	1"	9,08
RAC080102034	1" 1/4	11,04
RAC080102442	1" 1/2	18,63
RAC080103252	2"	18,80

**BOQUILLA BSPP CIERRE CONO 60°**

60° CONE BSPP NIPPLE  
EMBOUT BSPP FERMETURE CÔNE 60°



Ref.			€
RAC080110206	1/8	6	1,53
RAC080110406	1/4	6	2,73
RAC080110408	1/4	8	2,73
RAC080110606	3/8	6	2,11
RAC080110608	3/8	8	4,55
RAC080110610	3/8	10	3,32
RAC080110612	3/8	12	2,11
RAC080110810	1/2	10	2,47
RAC080110812	1/2	12	10,23

Ref.			€
RAC080110815	1/2	15	5,14
RAC080111212	3/4	12	3,45
RAC080111215	3/4	15	2,47
RAC080111219	3/4	19	6,62
RAC080111620	1"	20	5,15
RAC080111625	1"	25	5,22
RAC080112030	1" 1/4	30	10,60
RAC080112440	1" 1/2	40	28,57
RAC080113250	2"	50	26,96

### BOQUILLA BSPP CIERRE BASE PLANA

FLAT SEAT BSPP NIPPLE  
EMBOUT BSPP FERMETURE FOND PLAT



Ref.			€
RAC080120206	1/8	6	1,58
RAC080120406	1/4	6	1,72
RAC080120408	1/4	8	1,56
RAC080120610	3/8	10	1,70
RAC080120612	3/8	12	2,09
RAC080120810	1/2	10	2,00
RAC080120812	1/2	12	4,98
RAC080120815	1/2	15	2,20

Ref.			€
RAC080121215	3/4	15	3,12
RAC080121220	3/4	20	2,82
RAC080121616	1"	16	5,41
RAC080121620	1"	20	10,42
RAC080121625	1"	25	8,02
RAC080122030	1" 1/4	30	12,69
RAC080122440	1" 1/2	40	20,33
RAC080123250	2"	50	27,38

### MACHO BSPP CIERRE CONO 60°

60° CONE BSPP MALE  
MÂLE BSPP FERMETURE CONIQUE 60°



Ref.			€
RAC080130206	1/8	6	4,48
RAC080130406	1/4	6	5,69
RAC080130408	1/4	8	4,40
RAC080130608	3/8	8	3,24
RAC080130610	3/8	10	4,97
RAC080130612	3/8	12	4,92
RAC080130810	1/2	10	4,36
RAC080130812	1/2	12	8,24
RAC080130815	1/2	15	7,57

Ref.			€
RAC080130819	1/2	19	8,24
RAC080131212	3/4	12	6,94
RAC080131215	3/4	15	5,79
RAC080131220	3/4	20	12,52
RAC080131620	1"	20	15,79
RAC080131625	1"	25	13,97
RAC080132030	1" 1/4	30	39,93
RAC080132440	1" 1/2	40	31,50
RAC080133250	2"	50	43,31

### MACHO BSPP CIERRE BASE PLANA

FLAT SEAT BSPP MALE  
MÂLE BSPP FERMETURE FOND PLAT



Ref.			€
RAC080140206	1/8	6	2,12
RAC080140406	1/4	6	5,03
RAC080140408	1/4	8	5,69
RAC080140608	3/8	8	3,17
RAC080140610	3/8	10	4,14
RAC080140612	3/8	12	6,11
RAC080140810	1/2	10	4,36
RAC080140812	1/2	12	11,99
RAC080140815	1/2	15	8,09

Ref.			€
RAC080140819	1/2	19	8,87
RAC080141212	3/4	12	6,94
RAC080141215	3/4	15	5,79
RAC080141220	3/4	20	12,42
RAC080141620	1"	20	18,63
RAC080141625	1"	25	16,66
RAC080142030	1" 1/4	30	26,25
RAC080142440	1" 1/2	40	31,50
RAC080143250	2"	50	43,31

### CODO 90° BSPP CIERRE CONO 60°

BSPP 90° ELBOW 60° CONE  
COUDE 90° BSPP FERMETURE CONIQUE 60°



Ref.			€
RAC080150206	1/8	6	6,80
RAC080150406	1/4	6	6,60
RAC080150408	1/4	8	16,09
RAC080150608	3/8	8	9,73
RAC080150610	3/8	10	19,25
RAC080150812	1/2	12	17,70
RAC080150815	1/2	15	21,86

Ref.			€
RAC080151215	3/4	15	16,25
RAC080151220	3/4	20	19,43
RAC080151620	1"	20	28,27
RAC080151625	1"	25	36,04
RAC080152030	1" 1/4	30	48,57
RAC080152440	1" 1/2	40	117,35
RAC080153250	2"	50	145,19

### ESPIGA LISA

STANDPIPE  
EMBOUT LISSE



Ref.	Ø		€
RAC080540405	4	5	5,05
RAC080540606	6	6	3,43
RAC080540806	8	6	3,15
RAC080540808	8	8	3,15
RAC080541008	10	8	3,28

Ref.	Ø		€
RAC080541010	10	10	3,45
RAC080541210	12	10	3,43
RAC080541212	12	12	3,43
RAC080541515	15	15	5,31
RAC080541815	18	15	5,84

### TUERCA MÉTRICA

METRIC NUT  
ÉCROU MÉTRIQUE

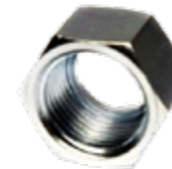

Ref.		€
RAC080601007	10x100	1,12
RAC080601208	12x150	1,10
RAC080601411	14x150	3,62
RAC080601611	16x150	1,42

Ref.		€
RAC080601813	18x150	1,96
RAC080602216	22x150	5,49
RAC080602620	26x150	3,17

### BOQUILLA MÉTRICA CIERRE CONO 60°

60° CONE METRIC NIPPLE  
EMBOUT MÉTRIQUE FERMETURE CONIQUE 60°



Ref.			€
RAC080611005	10x100	5	1,58
RAC080611207	12x150	7	1,65
RAC080611409	14x150	9	4,43
RAC080611609	16x150	9	1,73
RAC080611810	18x150	10	1,75

Ref.			€
RAC080611812	18x150	12	1,75
RAC080612212	22x150	12	1,86
RAC080612215	22x150	15	2,05
RAC080612612	26x150	12	3,45
RAC080612615	26x150	15	2,82

### BOQUILLA MÉTRICA CIERRE BASE PLANA

FLAT SEAT METRIC NIPPLE  
EMBOUT MÉTRIQUE FERMETURE FOND PLAT



Ref.			€
RAC080621005	10x100	5	1,58
RAC080621207	12x150	7	1,65
RAC080621409	14x150	9	1,65
RAC080621609	16x150	9	1,73
RAC080621810	18x150	10	1,75

Ref.			€
RAC080621812	18x150	12	1,75
RAC080622212	22x150	12	1,86
RAC080622215	22x150	15	1,86
RAC080622612	26x150	12	2,82
RAC080622615	26x150	15	2,82



**MACHO MÉTRICO CIERRE CONO 60°**  
60° CONE METRIC MALE  
MÂLE MÉTRIQUE FERMETURE CONIQUE 60°

Ref.			€
RAC080631005	10x100	5	2,13
RAC080631207	12x150	7	2,74
RAC080631409	14x150	9	4,15
RAC080631609	16x150	9	3,06
RAC080631612	16x150	12	3,12
RAC080631810	18x150	10	3,19
RAC080632212	22x150	12	3,38
RAC080632215	22x150	15	3,38
RAC080632612	26x150	12	4,90
RAC080632615	26x150	15	4,90



**MACHO MÉTRICO BASE PLANA**  
FLAT SEAT METRIC MALE  
MÂLE MÉTRIQUE FOND PLAT

Ref.			€
RAC080641005	10x100	5	2,20
RAC080641207	12x150	7	2,74
RAC080641409	14x150	9	2,52
RAC080641609	16x150	9	2,98
RAC080641612	16x150	12	5,59

Ref.			€
RAC080641810	18x150	10	3,19
RAC080642212	22x150	12	3,94
RAC080642215	22x150	15	3,94
RAC080642612	26x150	12	4,96
RAC080642615	26x150	15	4,96



**CODO 90° MÉTRICO CIERRE CONO 60°**  
90° METRIC ELBOW 60° CONE  
COUDE 90° MÉTRIQUE FERMETURE CONE 60°

Ref.			€
RAC080651006	10x100	6	7,21
RAC080651207	12x150	7	6,17
RAC080651409	14x150	9	12,83
RAC080651609	16x150	9	7,84
RAC080651810	18x150	10	7,73
RAC080652215	22x150	15	8,54
RAC080652615	26x150	15	14,99
RACMH220023	16x200	20	44,00

**ESFÉRICO MÉTRICO**  
METRIC BANJO  
BANJO MÉTRIQUE



Ref.	∅		€
RAC081000805	8	5	5,38
RAC081000807	8	7	6,62
RAC081001009	10	5	4,04
RAC081001205	12	5	4,56
RAC081001207	12	7	7,32
RAC081001209	12	9	7,14

Ref.	∅		€
RAC081000507	1/2	7	4,75
RAC081000509	1/2	9	4,75
RAC081001405	14	5	4,75
RAC081001609	16	9	6,53
RAC081002115	21	15	10,13



**BOQUILLA MÉTRICA PARA POLIAMIDA**  
METRIC NIPPLE FOR POLYAMIDE  
EMBOUT MÉTRIQUE POUR POLYAMIDE

Ref.			€
RAC081031005	10X150	5	2,31
RAC081031205	12X150	5	2,09
RAC081031407	14X150	7	2,09
RAC081031409	14X150	9	2,09
RAC081031609	16X150	9	2,09



**MACHO MÉTRICO PARA POLIAMIDA**  
METRIC MALE FOR POLYAMIDE  
MÂLE MÉTRIQUE POUR POLYAMIDE

Ref.			€
RAC081041005	10x100	5	3,49
RAC081041007	10x100	7	3,60
RAC081041205	12x150	5	3,93
RAC081041207	12x150	7	4,04
RAC081041409	14x150	9	4,24
RAC081041509	14x150	9	4,14
RAC081041609	16x150	9	5,00
RAC081041709	16x150	9	4,56



**TORNILLO ORIENTABLE SIMPLE MÉTRICO**  
SINGLE METRIC ADJUSTABLE BOLT  
VIS ORIENTABLE SIMPLE MÉTRIQUE

Ref.		€
RAC081100807	8X75	2,91
RAC081100812	8X125	3,13
RAC081101010	10X100	4,66
RAC081101012	10X125	3,11
RAC081101015	10X150	2,91
RAC081101215	12X150	4,59
RAC081101415	14X150	4,71
RAC081101615	16X150	5,60
RAC081101815	18X150	11,18
RAC081102015	20X150	7,84
RAC081102215	22X150	12,28



Las mangueras Vincke están probadas bajo la norma: EN ISO 6803:2017. Ensayo por pulsos de presión hidráulica. Podemos probar tus racores con nuestra manguera!

Vincke hoses are tested under EN ISO 6803:2017. Hydraulic pressure impulse test. We can test your fittings with our hose!

Les tuyaux Vincke sont testés selon la norme EN ISO 6803:2017. Test d'impulsion de pression hydraulique. Nous pouvons tester vos raccord à sertir avec notre tuyau !



## ESPECIALISTAS EN FABRICACIÓN DE MANGUERAS HIDRÁULICAS

### SPECIALISTS IN HYDRAULIC HOSES ASSEMBLY

### SPÉCIALISTES EN MONTAGE DE TUYAUX HYDRAULIQUES

Proporcionamos un servicio rápido de montaje de flexibles. Operando según los procesos DIN20066, nos aseguramos de que nuestros clientes siempre obtengan una manguera hidráulica ensamblada, segura y de alta calidad.

Providing a rapid high-quality hose assembly service. Operating to DIN20066 processes, we make sure our customers always get a safe, high quality, assembled hydraulic hose.

Nous assurons l'assemblage rapide de tuyaux de haute qualité. Opérant selon les processus DIN20066, nous nous assurons que nos clients obtiennent toujours un tuyau hydraulique assemblé sûr et de haute qualité.





En Vincke ofrecemos una amplia gama de conexiones para tubo rígido, diseñadas para garantizar fiabilidad, estanqueidad y resistencia mecánica en sistemas hidráulicos e industriales.

Nuestra oferta incluye:

- Racores DIN 2353
- Racores JIC/SAE de 37°
- Abrazaderas para tubo

Fabricados bajo estrictos controles de calidad y con recubrimientos anticorrosión de alta durabilidad, los componentes Vincke aseguran un ensamblaje seguro y duradero, incluso en entornos exigentes. Disponibles en acero al carbono y acero inoxidable AISI 316L, son compatibles con los estándares internacionales más utilizados.

At Vincke, we offer a comprehensive range of rigid tube fittings, designed to ensure reliable sealing, mechanical strength, and long-term durability in hydraulic and industrial systems.

Our portfolio includes:

- DIN 2353 fittings
- JIC/SAE 37° flare fittings
- Tube clamps

Manufactured under strict quality controls and treated with high-performance anti-corrosion coatings, Vincke components provide secure, durable assembly, even under demanding conditions. Available in carbon steel and stainless steel AISI 316L, they comply with major international standards.

Chez Vincke, nous proposons une large gamme de connectique pour tuyauterie rigide, conçus pour garantir une étanchéité fiable, une résistance mécanique élevée et une durabilité maximale dans les systèmes hydrauliques et industriels.

Notre offre comprend :

- Raccords DIN 2353
- Raccords JIC/SAE à 37°
- Colliers de fixation pour tubes

Fabriqués sous contrôle qualité strict et protégés par des revêtements anticorrosion performants, les composants Vincke assurent un assemblage sécurisé et durable, même dans les environnements les plus exigeants. Disponibles en acier carbone et acier inoxydable AISI 316L, ils sont conformes aux principales normes internationales.

## CONEXIONES PARA TUBO RÍGIDO

### PIPE CONNECTORS CONNECTIQUE RIGIDE

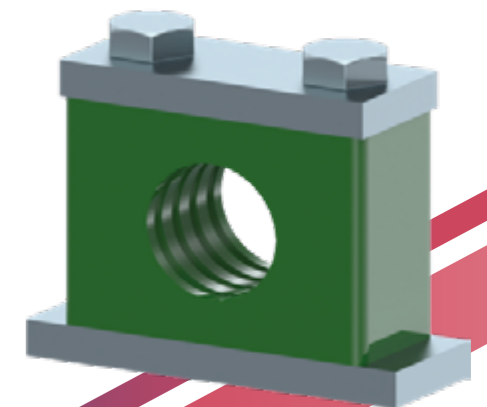

**CONEXIONES  
PARA TUBO RÍGIDO**  
PIPE CONNECTORS  
*CONNECTIQUE RIGIDE*

**01** **RACORES DIN2353**  
DIN2353 FITTINGS  
*RACCORDS DIN2353*  
**PÁGINA 124**

**02** **RACORES SAE JIC**  
SAE JIC FITTINGS  
*RACCORDS SAE JIC*  
**PÁGINA 152**

**03** **ABRAZADERAS**  
CLAMPS  
*COLLIERS*  
**PÁGINA 166**

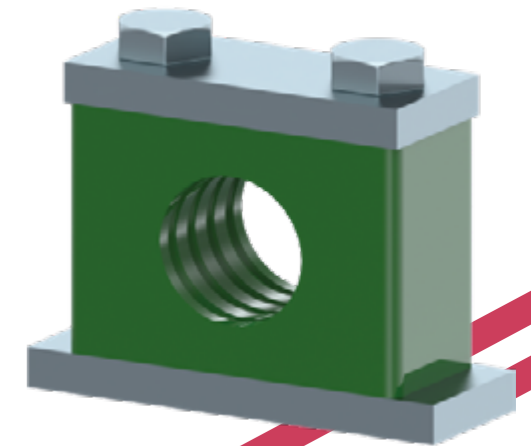

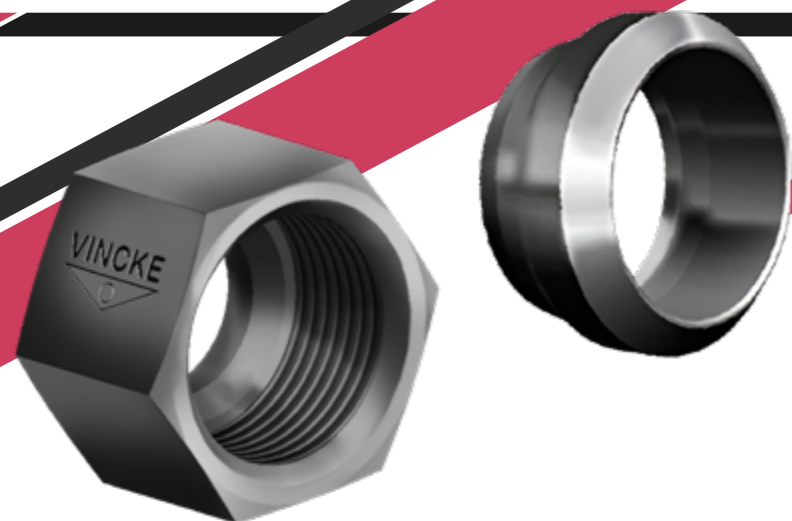

Los racores para tubo rígido Vincke, fabricados según las normas DIN EN ISO 8434-1 y DIN 2353, garantizan una conexión segura y estanca, incluso bajo altas presiones de trabajo, picos de presión y vibraciones intensas.

Gracias a su ajuste preciso y diseño optimizado, ofrecen una transición de flujo fluida, sin turbulencias, y son resistentes a fugas tanto de líquidos como de gases. Están disponibles en una amplia variedad de tipos, tamaños y materiales, lo que los hace ideales para múltiples aplicaciones industriales.

Vincke establece nuevos estándares en resistencia a la corrosión: los cuerpos, tuercas y anillos cortantes cuentan de serie con un recubrimiento de zinc-níquel sin CrVI, conforme a la norma DIN 50979, garantizando una resistencia a la corrosión de hasta 1.500 horas en cámara de niebla salina.

Disponemos de una amplia gama y rápida disponibilidad, lo que nos permite responder de forma ágil a las necesidades del mercado industrial y de mantenimiento.

Vincke tube fittings, manufactured according to DIN EN ISO 8434-1 and DIN 2353 standards, ensure reliable and leak-free connections, even under high working pressures, pressure spikes, and strong vibrations.

Thanks to their tight, form-fitting design and optimized flow paths, they offer smooth, turbulence-free transitions and are highly resistant to both fluid and gas leaks. Available in a wide range of types, sizes, and materials, they are suitable for demanding industrial environments. Vincke sets new standards in corrosion protection: all bodies, union nuts, and cutting rings feature a standard CrVI-free zinc-nickel coating, in compliance with DIN 50979, ensuring up to 1,500 hours of salt spray resistance.

*Les raccords pour tubes rigides Vincke, fabriqués selon les normes DIN EN ISO 8434-1 et DIN 2353, assurent une connexion fiable et étanche, même sous haute pression, pics de pression ou fortes vibrations.*

*Grâce à leur ajustement précis et à leur conception optimisée, ils garantissent une circulation fluide du fluide sans turbulences, tout en étant étanches aux liquides et aux gaz. Disponibles dans une vaste gamme de modèles, tailles et matériaux, ils conviennent à de nombreuses applications industrielles.*

*Vincke établit de nouveaux standards en matière de protection anticorrosion : les corps, écrous et bagues de coupe sont revêtus en standard d'un traitement zinc-nickel sans CrVI, conforme à la norme DIN 50979, offrant jusqu'à 1 500 heures de résistance au brouillard salin.*

## RACORES DIN2353

### DIN2353 FITTINGS

### RACCORDS DIN2353



# RACORES DIN2353

Vincke cuenta con una amplia experiencia en la fabricación de productos de precisión, y junto a un control de calidad riguroso, garantiza la excelencia de los racores DIN2353 desde la selección del material inicial hasta la entrega de las conexiones terminadas.

Los anillos de corte doble R y los racores DIN aseguran una estanqueidad perfecta y permiten un montaje y desmontaje sencillo.

Durante el premontaje, el anillo de corte, impulsado por la forma cónica de 24° del acople, se deforma y realiza dos incisiones en el tubo, garantizando así una estanqueidad perfecta.

El recubrimiento de Zn-Ni proporciona una resistencia excepcional, soportando hasta 720 horas sin corrosión blanca y 1,500 horas sin corrosión roja en pruebas de niebla salina. Este revestimiento de zinc-níquel, junto con la capa de sellado, ofrece un espesor uniforme, un coeficiente de fricción estable y una excelente resistencia al desgaste.

La fase de pasivación y sellado posterior permite alcanzar un rendimiento técnico y una resistencia a la corrosión que superan ampliamente los estándares habituales. De acuerdo con la norma UNI ISO 9227, nuestros racores DIN2353 han demostrado una resistencia superior a las 3.000 horas de exposición sin corrosión roja.



## DIN2353 FITTINGS

Vincke has extensive experience in the manufacturing of precision products and, together with rigorous quality control, guarantees the excellence of DIN2353 fittings from the selection of the initial material to the delivery of the finished connections.

The double cutting rings (R) and DIN fittings ensure perfect leak-tightness and allow for easy assembly and disassembly.

During pre-assembly, the cutting ring, driven by the 24° cone shape of the coupling, deforms and makes two incisions into the tube, thus ensuring perfect sealing.

The Zn-Ni coating provides exceptional resistance, withstanding up to 720 hours without white corrosion and 1,500 hours without red corrosion in salt spray tests. This zinc-nickel coating, together with the sealing layer, delivers uniform thickness, stable friction coefficient, and excellent wear resistance.

The passivation phase and subsequent sealing allow for technical performance and corrosion resistance that far exceed usual standards. In accordance with UNI ISO 9227, our DIN2353 fittings have demonstrated resistance of over 3.000 hours of exposure without red corrosion.

## RACCORDS DIN2353

Vincke possède une vaste expérience dans la fabrication de produits de précision et, avec un contrôle qualité rigoureux, garantit l'excellence des raccords DIN2353 depuis le choix du matériau initial jusqu'à la livraison des connexions terminées.

Les bagues de coupe double R et les raccords DIN garantissent une étanchéité parfaite et permettent un montage et un démontage aisés.

Lors du prémontage, l'anneau de coupe, entraîné par la forme conique de 24° de l'accouplement, se déforme et réalise deux incisions dans le tube, garantissant ainsi une étanchéité parfaite.

Le revêtement Zn-Ni offre une résistance exceptionnelle, pouvant résister jusqu'à 720 heures sans corrosion blanche et 1.500 heures sans corrosion rouge dans les tests de brouillard salin. Ce revêtement de zinc-nickel, avec la couche d'étanchéité, offre une épaisseur uniforme, un coefficient de frottement stable et une excellente résistance à l'usure. La phase de passivation et d'étanchéification ultérieure permet d'atteindre des performances techniques et une résistance à la corrosion largement supérieures aux normes habituelles. Conformément à la norme UNI ISO 9227, nos raccords DIN2353 ont démontré une résistance supérieure à 3.000 heures d'exposition sans corrosion rouge.

**BICONOS Y TUERCAS**  
NUT & RINGS  
BAGUES ET ÉCROUS

**RACOR CON TUERCA Y BICONO**  
FITTING WITH NUT AND RING  
RACCORD AVEC ECROU ET BAGUE

**ANILLO CORTANTE DIN 3861**

DIN 3861 CUTTING RING  
BAGUE COUPANTE DIN 3861



R

Ref.	∅	€
PFZRLS06	6LS	0,41
PFZRLS08	8LS	0,47
PFZRLS10	10LS	0,57
PFZRLS12	12LS	0,67
PFZRL15	15L	0,83
PFZRL18	18L	0,93
PFZRL22	22LL	1,24
PFZRL28	28L	1,81

Ref.	∅	€
PFZRL28	35L	1,81
PFZRL42	42L	2,95
PFZRS14	14S	0,83
PFZRS16	16S	0,93
PFZRS20	20S	1,24
PFZRS25	25S	1,55
PFZRS30	30S	1,91
PFZRS38	38S	2,74

**ANILLO CORTANTE CON JUNTA MOLDEADA DIN 3861**

DIN 3861 SOFT SEALING CUTTING RING  
BAGUE COUPANTE AVEC LE SCEAU DOUX DIN 3861



RE

Ref.	∅	€
PFZREL06	6L	4,70
PFZREL08	8L	4,84
PFZREL10	10L	5,43
PFZREL12	12L	5,70
PFZREL15	15L	6,76
PFZREL18	18L	8,68
PFZREL22	22L	9,01
PFZREL28	28L	10,86
PFZREL35	35L	16,36
PFZREL42	42L	18,81

Ref.	∅	€
PFZRES06	6S	5,23
PFZRES08	8S	5,43
PFZRES10	10S	6,29
PFZRES12	12S	6,36
PFZRES14	14S	7,75
PFZRES16	16S	8,74
PFZRES20	20S	9,54
PFZRES25	25S	12,39
PFZRES30	30S	17,22
PFZRES38	38S	19,14

**TUERCA MÉTRICA**

METRIC NUT  
ÉCROU MÉTRIQUE

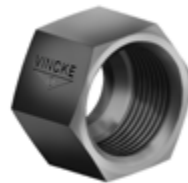

N

Ref.	∅	€
PFZNL06	6L	0,49
PFZNL08	8L	0,53
PFZNL10	10L	0,61
PFZNL12	12L	0,70
PFZNL15	15L	1,35
PFZNL18	18L	1,93
PFZNL22	22L	2,67
PFZNL28	35L	4,20
PFZNL28	35L	8,39
PFZNL42	42L	9,77

Ref.	∅	€
PFZNS06	6S	0,66
PFZNS08	8S	0,82
PFZNS10	10S	1,26
PFZNS12	12S	1,39
PFZNS14	14S	2,02
PFZNS16	16S	2,64
PFZNS20	20S	3,94
PFZNS25	25S	4,68
PFZNS30	30S	5,69
PFZNS38	38S	10,46



G1

**UNIÓN RECTO TUBO TUBO**

TUBE TUBE STRAIGHT UNION  
UNION DROIT TUBE TUBE

Ref.	∅	€
PFZNRG1L06	6L	4,68
PFZNRG1L08	8L	4,82
PFZNRG1L10	10L	5,51
PFZNRG1L12	12L	5,64
PFZNRG1L15	15L	8,26
PFZNRG1L18	18L	10,73
PFZNRG1L22	22L	14,73
PFZNRG1L28	28L	20,65
PFZNRG1L35	35L	34,41
PFZNRG1L42	42L	49,56

**UNIÓN TUBO TUBO**  
TUBE TUBE UNION FITTING  
UNION TUBE TUBE

Ref.	∅	€
PFZNRG1S06	6S	4,96
PFZNRG1S08	8S	5,51
PFZNRG1S10	10S	6,88
PFZNRG1S12	12S	7,58
PFZNRG1S14	14S	10,73
PFZNRG1S16	16S	11,01
PFZNRG1S20	20S	16,52
PFZNRG1S25	25S	27,53
PFZNRG1S30	30S	38,54
PFZNRG1S38	38S	57,82



G1R

**UNIÓN REDUCTOR TUBO TUBO**

TUBE TUBE REDUCER UNION  
UNION RÉDUCTEUR TUBE TUBE

Ref.	∅	€
PFZNRG1RL0806	8/6L	4,82
PFZNRG1RL1006	10/6L	5,51
PFZNRG1RL1008	10/8L	5,51
PFZNRG1RL1206	12/6L	5,79
PFZNRG1RL1208	12/8L	5,79
PFZNRG1RL1210	12/10L	5,79
PFZNRG1RL1510	15/10L	7,98
PFZNRG1RL1512	15/12L	7,98
PFZNRG1RL1810	18/10L	10,05
PFZNRG1RL1812	18/12L	10,05
PFZNRG1RL1815	18/15L	10,05
PFZNRG1RL2212	22/12L	13,77
PFZNRG1RL2215	22/15L	13,77
PFZNRG1RL2218	22/18L	13,77
PFZNRG1RL2818	28/18L	20,65
PFZNRG1RL2822	28/22L	20,65
PFZNRG1RL3522	35/22L	60,57
PFZNRG1RL3528	35/28L	60,57
PFZNRG1RS0806	8/6S	5,92

Ref.	∅	€
PFZNRG1RS1006	10/6S	6,20
PFZNRG1RS1008	10/8S	6,20
PFZNRG1RS1206	12/6S	7,58
PFZNRG1RS1208	12/8S	7,58
PFZNRG1RS1210	12/10S	7,58
PFZNRG1RS1410	14/10S	9,64
PFZNRG1RS1412	14/12S	9,64
PFZNRG1RS1612	16/12S	9,64
PFZNRG1RS1614	16/14S	9,64
PFZNRG1RS2010	20/10S	16,52
PFZNRG1RS2012	20/12S	16,52
PFZNRG1RS2014	20/14S	16,52
PFZNRG1RS2016	20/16S	16,52
PFZNRG1RS2516	25/16S	23,40
PFZNRG1RS2520	25/20S	23,40
PFZNRG1RS3020	30/20S	55,06
PFZNRG1RS3025	30/25S	55,06
PFZNRG1RS3825	38/25S	75,71
PFZNRG1RS3830	38/30S	75,71

**CUERPO RECTO PASATABIQUE TUBO TUBO**

TUBE TUBE BULKHEAD STRAIGHT FITTING  
RACCORD DROIT PASSE-CLOISON TUBE TUBE



**B1**

Ref.	Ø	€
PFZNRB1L06	6L	6,88
PFZNRB1L08	8L	7,58
PFZNRB1L10	10L	8,26
PFZNRB1L12	12L	9,92
PFZNRB1L15	15L	13,77
PFZNRB1L18	18L	20,65
PFZNRB1L22	22L	23,40
PFZNRB1L28	28L	34,41
PFZNRB1L35	35L	48,18
PFZNRB1L42	42L	61,94

Ref.	Ø	€
PFZNRB1S06	6S	8,26
PFZNRB1S08	8S	9,09
PFZNRB1S10	10S	11,01
PFZNRB1S12	12S	12,39
PFZNRB1S14	14S	17,90
PFZNRB1S16	16S	16,52
PFZNRB1S20	20S	27,53
PFZNRB1S25	25S	45,43
PFZNRB1S30	30S	52,31
PFZNRB1S38	38S	61,07

**CODO 90° PASAMUROS TUBO TUBO**

TUBE TUBE BULKHEAD 90° ELBOW FITTING  
RACCORD COUDE 90° PASSE-CLOISON TUBE TUBE



**B2**

Ref.	Ø	€
PFZNRB2L06	6L	11,41
PFZNRB2L08	8L	11,59
PFZNRB2L10	10L	13,08
PFZNRB2L12	12L	15,61
PFZNRB2L15	15L	15,14
PFZNRB2L18	18L	26,02
PFZNRB2L22	22L	32,65
PFZNRB2L28	28L	59,19
PFZNRB2L35	35L	79,84
PFZNRB2L42	42L	116,46

Ref.	Ø	€
PFZNRB2S06	6S	17,60
PFZNRB2S08	8S	18,61
PFZNRB2S10	10S	16,25
PFZNRB2S12	12S	20,10
PFZNRB2S14	14S	20,37
PFZNRB2S16	16S	27,58
PFZNRB2S20	20S	41,71
PFZNRB2S25	25S	68,83
PFZNRB2S30	30S	79,84
PFZNRB2S38	38S	136,28

**TUERCA PASATABIQUE**

NUT BULKHEAD  
ECROU PASSE CLOISON



**B5**

Ref.	Ø	€
PFZB512	6L	0,85
PFZB514	6S/8L	0,91
PFZB516	10L/8S	1,14
PFZB518	12L/10S	1,25
PFZB520	12S	1,48
PFZB522	15L/14S	1,48
PFZB524	16S	1,82

Ref.	Ø	€
PFZB526	18L	2,16
PFZB530	22L/20S	3,53
PFZB536	28L/25S	4,33
PFZB542	30S	6,26
PFZB545	35L	7,29
PFZB552	42L/38S	8,20

**UNIÓN T TUBO TUBO**

TUBE TUBE T UNION  
UNION T TUBE TUBE



**T1**

Ref.	Ø	€
PFZNRT1L06	6L	8,80
PFZNRT1L08	8L	10,35
PFZNRT1L10	10L	11,39
PFZNRT1L12	12L	12,42
PFZNRT1L15	15L	16,97
PFZNRT1L18	18L	25,39
PFZNRT1L22	22L	32,99
PFZNRT1L28	28L	43,60
PFZNRT1L35	35L	71,90
PFZNRT1L42	42L	88,60

Ref.	Ø	€
PFZNRT1S06	6S	9,32
PFZNRT1S08	8S	11,39
PFZNRT1S10	10S	12,42
PFZNRT1S12	12S	15,63
PFZNRT1S14	14S	18,86
PFZNRT1S16	16S	26,33
PFZNRT1S20	20S	36,79
PFZNRT1S25	25S	52,79
PFZNRT1S30	30S	59,00
PFZNRT1S38	38S	91,08

**UNIÓN CODO 90° TUBO TUBO**

TUBE TUBE 90° UNION ELBOW  
UNION COUDE 90° TUBE TUBE



**W1**

Ref.	Ø	€
PFZNRW1L06	6L	7,04
PFZNRW1L08	8L	7,16
PFZNRW1L10	10L	8,71
PFZNRW1L12	12L	10,17
PFZNRW1L15	15L	13,80
PFZNRW1L18	18L	16,56
PFZNRW1L22	22L	22,49
PFZNRW1L28	28L	31,88
PFZNRW1L35	35L	47,49
PFZNRW1L42	42L	60,93

Ref.	Ø	€
PFZNRW1S06	6S	6,32
PFZNRW1S08	8S	7,86
PFZNRW1S10	10S	10,01
PFZNRW1S12	12S	9,39
PFZNRW1S14	14S	13,33
PFZNRW1S16	16S	14,83
PFZNRW1S20	20S	23,11
PFZNRW1S25	25S	33,81
PFZNRW1S30	30S	45,20
PFZNRW1S38	38S	62,86

**UNIÓN CRUZ TUBO TUBO**

TUBE TUBE CROSS UNION  
UNION CROIX TUBE TUBE



**C1**

Ref.	Ø	€
PFZNRCL06	6L	19,35
PFZNRCL08	8L	23,08
PFZNRCL10	10L	25,88
PFZNRCL12	12L	33,12
PFZNRCL15	15L	45,75
PFZNRCL18	18L	68,72
PFZNRCL22	22L	88,70
PFZNRCL28	28L	117,78
PFZNRCL35	35L	199,03
PFZNRCL42	42L	242,19

Ref.	Ø	€
PFZNRCS06	6S	23,08
PFZNRCS08	8S	25,46
PFZNRCS10	10S	32,71
PFZNRCS12	12S	36,74
PFZNRCS14	14S	46,16
PFZNRCS16	16S	60,44
PFZNRCS20	20S	91,18
PFZNRCS25	25S	123,58
PFZNRCS30	30S	153,08
PFZNRCS38	38S	247,99

**TUBO A HEMBRA GIRATORIA**  
TUBE TO SWIVEL  
TUBE À FEMELLE TOURNANTE



**W2**

**CODO 90° HEMBRA GIRATORIA**

90° ELBOW SWIVEL  
COUDE 90° FEMELLE TOURNANTE

Ref.	Ø	€
PFZNRW2L06	6L	6,67
PFZNRW2L08	8L	6,88
PFZNRW2L10	10L	7,21
PFZNRW2L12	12L	10,28
PFZNRW2L15	15L	11,19
PFZNRW2L18	18L	16,57
PFZNRW2L22	22L	23,11
PFZNRW2L28	28L	41,89
PFZNRW2L35	35L	57,75
PFZNRW2L42	42L	77,97

Ref.	Ø	€
PFZNRW2S06	6S	6,08
PFZNRW2S08	8S	7,04
PFZNRW2S10	10S	8,49
PFZNRW2S12	12S	9,11
PFZNRW2S14	14S	9,80
PFZNRW2S16	16S	13,94
PFZNRW2S20	20S	23,53
PFZNRW2S25	25S	42,85
PFZNRW2S30	30S	51,62
PFZNRW2S38	38S	78,94

**CODO 45° HEMBRA GIRATORIA**

45° ELBOW SWIVEL  
CODO 45° HEMBRA GIRATORIA



**W3**

Ref.	Ø	€
PFZNRW3L06	6L	6,90
PFZNRW3L08	8L	7,68
PFZNRW3L10	10L	8,97
PFZNRW3L12	12L	10,78
PFZNRW3L15	15L	12,24
PFZNRW3L18	18L	19,06
PFZNRW3L22	22L	29,24
PFZNRW3L28	28L	53,04
PFZNRW3L35	35L	73,14
PFZNRW3L42	42L	98,76

Ref.	Ø	€
PFZNRW3S06	6S	7,68
PFZNRW3S08	8S	8,88
PFZNRW3S10	10S	10,69
PFZNRW3S12	12S	11,56
PFZNRW3S16	16S	17,60
PFZNRW3S20	20S	29,76
PFZNRW3S25	25S	54,25
PFZNRW3S30	30	65,29
PFZNRW3S38	38S	99,96

**TE HEMBRA GIRATORIA CENTRAL**

SWIVEL NUT BRANC TEE  
TE FEMELLE TOURNANTE CENTRAL



**T2**

Ref.	Ø	€
PFZNRT2L06	6L	9,66
PFZNRT2L08	8L	10,35
PFZNRT2L10	10L	12,91
PFZNRT2L12	12L	13,97
PFZNRT2L15	15L	17,80
PFZNRT2L18	18L	26,90
PFZNRT2L22	22L	34,36
PFZNRT2L28	28L	49,96
PFZNRT2L35	35L	98,05
PFZNRT2L42	42L	114,68

Ref.	Ø	€
PFZNRT2S06	6S	10,35
PFZNRT2S08	8S	12,76
PFZNRT2S10	10S	15,60
PFZNRT2S12	12S	16,69
PFZNRT2S14	14S	17,94
PFZNRT2S14	16S	24,15
PFZNRT2S20	20S	35,19
PFZNRT2S25	25S	51,88
PFZNRT2S30	30S	87,56
PFZNRT2S38	38S	116,61



**T4**

**TE HEMBRA GIRATORIA LATERAL**

SWIVEL NUT RUN TEE  
SWIVEL NUT RUN TEE

Ref.	Ø	€
PFZNRT4L06	6L	9,66
PFZNRT4L08	8L	10,35
PFZNRT4L10	10L	12,91
PFZNRT4L12	12L	13,97
PFZNRT4L15	15L	17,80
PFZNRT4L18	18L	26,90
PFZNRT4L22	22L	34,36
PFZNRT4L28	28L	49,96
PFZNRT4L35	35L	98,05
PFZNRT4L42	42L	114,68

Ref.	Ø	€
PFZNRT4S06	6S	10,35
PFZNRT4S08	8S	12,76
PFZNRT4S10	10S	15,60
PFZNRT4S12	12S	16,69
PFZNRT4S14	14S	17,94
PFZNRT4S16	16S	24,15
PFZNRT4S20	20S	35,19
PFZNRT4S25	25S	51,88
PFZNRT4S30	30S	87,56
PFZNRT4S38	38S	116,61

**HEMBRA GIRATORIA A TUBO REDUCIDO**

TUB END REDUCER  
Zn-Ni REDUC. TUBE FT MÂLE K0-8/6L



**K0**

Ref.	Ø	€
PFZNRK0L0806	8/6L	5,51
PFZNRK0L1006	10/6L	5,79
PFZNRK0L1008	10/8L	5,79
PFZNRK0L1206	12/6L	6,20
PFZNRK0L1208	12/8L	6,20
PFZNRK0L1210	12/10L	6,20
PFZNRK0L1506	15/6L	6,88
PFZNRK0L1508	15/8L	6,88
PFZNRK0L1510	15/10L	6,88
PFZNRK0L1512	15/12L	6,88
PFZNRK0L1806	18/6L	16,52
PFZNRK0L1808	18/8L	16,52
PFZNRK0L1810	18/10L	9,64
PFZNRK0L1812	18/12L	9,64
PFZNRK0L1815	18/15L	12,39
PFZNRK0L2210	22/10L	21,97
PFZNRK0L2212	22/12L	21,97
PFZNRK0L2215	22/15L	21,97
PFZNRK0L2218	22/18L	21,97
PFZNRK0L2815	28/15L	29,29
PFZNRK0L2818	28/18L	29,29
PFZNRK0L2822	28/22L	29,29
PFZNRK0L3518	35/18L	54,93
PFZNRK0L3522	35/22L	36,62
PFZNRK0L3528	35/28L	36,62
PFZNRK0L4222	42/22L	73,24
PFZNRK0L4228	42/28L	73,24
PFZNRK0L4235	42/35L	64,08
PFZNRK0S0806	8/6S	25,63

Ref.	Ø	€
PFZNRK0S1006	10/6S	27,46
PFZNRK0S1008	10/8S	27,46
PFZNRK0S1206	12/6S	28,38
PFZNRK0S1208	12/8S	28,38
PFZNRK0S1210	12/10S	28,38
PFZNRK0S1410	14/10S	36,62
PFZNRK0S1412	14/12S	36,62
PFZNRK0S1606	16/6S	36,62
PFZNRK0S1608	16/8S	36,62
PFZNRK0S1610	16/10S	36,62
PFZNRK0S1612	16/12S	36,62
PFZNRK0S1614	16/14S	36,62
PFZNRK0S2008	20/8S	40,28
PFZNRK0S2010	20/10S	40,28
PFZNRK0S2012	20/12S	40,28
PFZNRK0S2014	20/14S	40,28
PFZNRK0S2016	20/16S	40,28
PFZNRK0S2510	25/10	43,94
PFZNRK0S2512	25/12S	43,94
PFZNRK0S2514	25/14S	43,94
PFZNRK0S2516	25/16S	43,94
PFZNRK0S2520	25/20S	43,94
PFZNRK0S3016	30/16S	54,93
PFZNRK0S3020	30/20S	54,93
PFZNRK0S3025	35/25S	54,93
PFZNRK0S3816	38/16S	69,57
PFZNRK0S3820	38/20S	69,57
PFZNRK0S3825	38/25S	69,57

**UNION HEMBRA GIRATORIA**  
SWIVEL TO SWIVEL  
UNION DOUBLE TOURNANTE



**G5**

Ref.	Ø	€
PFZG5L06	6L	16,52
PFZG5L08	8L	7,58
PFZG5L10	10L	8,47
PFZG5L12	12L	10,1
PFZG5L15	15L	13,08
PFZG5L18	18L	16,52
PFZG5L22	22L	33,04
PFZG5L28	28L	41,30
PFZG5L35	35L	61,94
PFZG5L42	42L	99,11

Ref.	Ø	€
PFZG5S06	6S	17,21
PFZG5S08	8S	18,86
PFZG5S10	10S	20,65
PFZG5S12	12S	22,72
PFZG5S14	14S	26,15
PFZG5S16	16S	16,52
PFZG5S20	20S	35,79
PFZG5S25	25S	45,43
PFZG5S30	30S	68,83
PFZG5S38	38S	103,24

**RECTO MACHO**  
MALE STUD CONNECTOR  
DROIT MÂLE



**G2-R-ED**

**RECTO ROSCA BSP ED**  
BSP MALE ED STUD CONNECTOR  
DROIT FILETAGE BSP ED

Ref.	Ø	€
PFZNRG2LRE0602	6L 1/8	3,58
PFZNRG2LRE0604	6L 1/4	4,13
PFZNRG2LRE0606	6L 3/8	4,26
PFZNRG2LRE0608	6L 1/2	6,05
PFZNRG2LRE0802	8L 1/8	4,09
PFZNRG2LRE0804	8L 1/4	4,00
PFZNRG2LRE0806	8L 3/8	4,26
PFZNRG2LRE0808	8L 1/2	6,05
PFZNRG2LRE1002	10L 1/8	4,26
PFZNRG2LRE1004	10L 1/4	4,26
PFZNRG2LRE1006	10L 3/8	4,82
PFZNRG2LRE1008	10L 1/2	6,05
PFZNRG2LRE1204	12L 1/4	4,76
PFZNRG2LRE1206	12L 3/8	4,66
PFZNRG2LRE1208	12L 1/2	5,28
PFZNRG2LRE1506	15L 3/8	6,33
PFZNRG2LRE1508	15L 1/2	6,88
PFZNRG2LRE1512	15L 3/4	7,76
PFZNRG2LRE1808	18L 1/2	8,88
PFZNRG2LRE1812	18L 3/4	8,95
PFZNRG2LRE2208	22L 1/2	9,64
PFZNRG2LRE2212	22L 3/4	10,33
PFZNRG2LRE2216	22L 1	14,49
PFZNRG2LRE2812	28L 3/4	15,73
PFZNRG2LRE2816	28L 1	15,73
PFZNRG2LRE3516	35L 1	27,53
PFZNRG2LRE3520	35L 1 1/4	27,53

Ref.	Ø	€
PFZNRG2LRE4224	42L 1 1/2	35,79
PFZNRG2SRE0604	6S 1/4	3,62
PFZNRG2SRE0606	6S 3/8	4,14
PFZNRG2SRE0608	6S 1/2	4,66
PFZNRG2SRE0804	8S 1/4	3,62
PFZNRG2SRE0806	8S 3/8	4,14
PFZNRG2SRE0808	8S 1/2	4,66
PFZNRG2SRE1004	10S 1/4	3,93
PFZNRG2SRE1006	10S 3/8	4,14
PFZNRG2SRE1008	10S 1/2	4,66
PFZNRG2SRE1204	12S 1/4	4,35
PFZNRG2SRE1206	12S 3/8	4,35
PFZNRG2SRE1208	12S 1/2	5,28
PFZNRG2SRE1406	14S 3/8	6,16
PFZNRG2SRE1408	14S 1/2	6,00
PFZNRG2SRE1606	16S 3/8	6,21
PFZNRG2SRE1608	16S 1/2	7,22
PFZNRG2SRE1612	16S 3/4	8,80
PFZNRG2SRE2008	20S 1/2	9,32
PFZNRG2SRE2012	20S 3/4	9,32
PFZNRG2SRE2016	20S 1	12,94
PFZNRG2SRE2512	25S 3/4	15,06
PFZNRG2SRE2516	25S 1	17,27
PFZNRG2SRE3016	30S 1	18,63
PFZNRG2SRE3020	30S 1 1/4	18,63
PFZNRG2SRE3820	38S 1 1/4	30,02
PFZNRG2SRE3824	38S 1 1/2	30,02



**G2-R**

**RECTO ROSCA BSP**  
BSP MALE STUD CONNECTOR  
DROIT FILETAGE BSP

Ref.	Ø	€
PFZNRG2LR0602	6L 1/8	3,58
PFZNRG2LR0604	6L 1/4	4,13
PFZNRG2LR0802	8L 1/8	4,09
PFZNRG2LR0804	8L 1/4	4,00
PFZNRG2LR0806	8L 3/8	4,26
PFZNRG2LR0808	8L 1/2	6,05
PFZNRG2LR1004	10L 1/4	4,26
PFZNRG2LR1006	10L 3/8	4,82
PFZNRG2LR1008	10L 1/2	6,05
PFZNRG2LR1204	12L 1/4	4,76
PFZNRG2LR1206	12L 3/8	4,66
PFZNRG2LR1208	12L 1/2	5,28
PFZNRG2LR1506	15L 3/8	6,33
PFZNRG2LR1508	15L 1/2	6,88
PFZNRG2LR1808	18L 1/2	8,88
PFZNRG2LR1812	18L 3/4	8,95
PFZNRG2LR2208	22L 1/2	9,64
PFZNRG2LR2212	22L 3/4	10,33
PFZNRG2LR2812	28L 3/4	15,73
PFZNRG2LR2816	28L 1	15,73
PFZNRG2LR3516	35L 1	27,53
PFZNRG2LR3520	35L 1 1/4	27,53
PFZNRG2LR4224	42L 1 1/2	35,79
PFZNRG2SR0604	6S 1/4	3,45
PFZNRG2SR0606	6S 3/8	3,93



**G2-RT**

**RECTO ROSCA BSPT**  
BSPT MALE STUD CONNECTOR  
DROIT FILETAGE BSPT

Ref.	Ø	€
PFZNRG2LRT0602	6L 1/8	3,52
PFZNRG2LRT0604	6L 1/4	3,62
PFZNRG2LRT0802	8L 1/8	3,45
PFZNRG2LRT0804	8L 1/4	3,62
PFZNRG2LRT0806	8L 3/8	4,00
PFZNRG2LRT0808	8L 1/2	5,51
PFZNRG2LRT1004	10L 1/4	4,13
PFZNRG2LRT1006	10L 3/8	4,66
PFZNRG2LRT1008	10L 1/2	5,51
PFZNRG2LRT1204	12L 1/4	5,51
PFZNRG2LRT1206	12L 3/8	5,51
PFZNRG2LRT1208	12L 1/2	6,73
PFZNRG2LRT1506	15L 1/4	7,58
PFZNRG2LRT1508	15L 1/2	7,58
PFZNRG2LRT1808	18L 1/2	7,58
PFZNRG2LRT2212	22L 3/8	9,64
PFZNRG2LRT2816	28L 1"	16,52
PFZNRG2LRT3520	35L 1" 1/4	30,02
PFZNRG2LRT4224	42L 1" 1/2	39,33

Ref.	Ø	€
PFZNRG2SR0608	6S 1/2	4,43
PFZNRG2SR0804	8S 1/4	3,45
PFZNRG2SR0806	8S 3/8	3,93
PFZNRG2SR0808	8S 1/2	4,43
PFZNRG2SR1004	10S 1/4	3,74
PFZNRG2SR1006	10S 3/8	5,51
PFZNRG2SR1008	10S 1/2	6,20
PFZNRG2SR1204	12S 1/4	5,79
PFZNRG2SR1206	12S 3/8	5,79
PFZNRG2SR1208	12S 1/2	6,20
PFZNRG2SR1406	14S 3/8	7,30
PFZNRG2SR1408	14S 1/2	7,58
PFZNRG2SR1606	16S 3/8	8,26
PFZNRG2SR1608	16S 1/2	8,26
PFZNRG2SR1612	16S 3/4	10,33
PFZNRG2SR2008	20S 1/2	12,39
PFZNRG2SR2012	20S 3/4	12,39
PFZNRG2SR2016	20S 1	17,21
PFZNRG2SR2512	25S 3/4	17,27
PFZNRG2SR2516	25S 1	17,27
PFZNRG2SR3016	30S 1	24,78
PFZNRG2SR3020	30S 1 1/4	24,78
PFZNRG2SR3820	38S 1 1/4	39,92
PFZNRG2SR3824	38S 1 1/2	39,92

Ref.	Ø	€
PFZNRG2SRT0604	6S 1/4	3,11
PFZNRG2SRT0804	8S 1/4	4,14
PFZNRG2SRT1004	10S 1/4	4,14
PFZNRG2SRT1006	10S 3/8	4,14
PFZNRG2SRT1204	12S 1/4	5,80
PFZNRG2SRT1206	12S 3/8	5,80
PFZNRG2SRT1208	12S 1/2	6,73
PFZNRG2SRT1406	14S 3/8	6,73
PFZNRG2SRT1408	14S 1/2	6,73
PFZNRG2SRT1606	16S 3/8	6,73
PFZNRG2SRT1608	16S 1/2	6,73
PFZNRG2SRT2008	20S 1/2	9,32
PFZNRG2SRT2012	20S 3/4	9,32
PFZNRG2SRT2512	25S 3/4	13,46
PFZNRG2SRT2516	25S 1"	13,46
PFZNRG2SRT3016	30S 1"	39,33
PFZNRG2SRT3020	30S 1" 1/4	39,33
PFZNRG2SRT3824	38S 1" 1/2	32,09



**G2-NPT**

**RECTO ROSCA NPPT**  
NPT MALE STUD CONNECTOR  
DROIT FILETAGE NPT

Ref.	Ø	Filetado	€
PFZNRG2LN0602	6L	1/8	3,58
PFZNRG2LN0604	6L	1/4	3,72
PFZNRG2LN0802	8L	1/8	3,72
PFZNRG2LN0804	8L	1/4	3,72
PFZNRG2LN0808	10L	1/8	4,13
PFZNRG2LN1004	10L	1/4	4,13
PFZNRG2LN1006	10L	3/8	4,66
PFZNRG2LN1008	10L	1/2	5,51
PFZNRG2LN1204	12L	1/4	5,51
PFZNRG2LN1206	12L	3/8	5,51
PFZNRG2LN1208	12L	1/2	6,88
PFZNRG2LN1506	15L	3/8	7,58
PFZNRG2LN1508	15L	1/2	7,58
PFZNRG2LN1808	18L	1/2	8,26
PFZNRG2LN2212	22L	3/4	11,01
PFZNRG2LN2816	28L	1"	16,51
PFZNRG2LN3520	35L	1"1/4	30,02
PFZNRG2LN4224	42L	1"1/2	40,37

Ref.	Ø	Filetado	€
PFZNRG2SN0604	6S	1/4	3,11
PFZNRG2SN0804	8S	1/4	4,14
PFZNRG2SN1004	10S	1/4	4,14
PFZNRG2SN1006	10S	3/8	4,14
PFZNRG2SN1204	12S	1/4	5,80
PFZNRG2SN1206	12S	3/8	5,80
PFZNRG2SN1208	12S	1/2	6,73
PFZNRG2SN1408	14S	1/2	6,73
PFZNRG2SN1606	16S	3/8	6,73
PFZNRG2SN1608	16S	3/8	6,73
PFZNRG2SN2008	20S	1/2	9,32
PFZNRG2SN2012	20S	3/4	9,32
PFZNRG2SN2512	25S	3/4	13,46
PFZNRG2SN2516	25S	1"	13,46
PFZNRG2SN3016	30S	1"	39,33
PFZNRG2SN3020	30S	1"1/4	39,33
PFZNRG2SN3824	38S	1"1/4	32,09



**E6-R-ED**

**HEMBRA GIRATORIA ROSCA MACHO BSP ED**  
SWIVEL CONNECTOR BSP ED  
FEMELLE TOURNANTE FILETAGE MÂLE BSP ED

Ref.	Ø	Filetado	€
PFZE6LRE0602	6L	1/8	4,66
PFZE6LRE0804	8L	1/4	4,66
PFZE6LRE0806	8L	3/8	6,47
PFZE6LRE1004	10L	1/4	6,33
PFZE6LRE1006	10L	3/8	6,73
PFZE6LRE1204	12L	1/4	7,87
PFZE6LRE1206	12L	3/8	6,21
PFZE6LRE1208	12L	1/2	8,64
PFZE6LRE1506	15L	3/8	8,26
PFZE6LRE1508	15L	1/2	8,26
PFZE6LRE1808	18L	1/2	8,94
PFZE6LRE2212	22L	3/4	11,01
PFZE6LRE2816	28L	1	19,27
PFZE6LRE3520	35L	1"1/4	38,54

Ref.	Ø	Filetado	€
PFZE6LRE4224	42L	1"1/2	48,18
PFZE6SRE0604	6S	1/4	6,60
PFZE6SRE0804	8S	1/4	6,20
PFZE6SRE0806	8S	3/8	6,20
PFZE6SRE1004	10S	1/4	6,20
PFZE6SRE1006	10S	3/8	6,20
PFZE6SRE1206	12S	3/8	7,37
PFZE6SRE1208	12S	1/2	7,98
PFZE6SRE1408	14S	1/2	8,54
PFZE6SRE1608	16S	1/2	9,64
PFZE6SRE2012	20S	3/4	15,14
PFZE6SRE2516	25S	1	24,78
PFZE6SRE3020	30S	1"1/4	44,04
PFZE6SRE3824	38S	1"1/2	61,94



**G2-M-ED**

**RECTO ROSCA MÉTRICA**  
METRIC MALE STUD CONNECTOR  
DROIT FILETAGE METRIQUE

Ref.	Ø	Filetado	€
PFZNRG2LME0610	6L	10X1,5	4,13
PFZNRG2LME0812	8L	12X1,5	4,14
PFZNRG2LME0814	8L	14X1,5	4,35
PFZNRG2LME0816	8L	16X1,5	4,35
PFZNRG2LME1014	10L	14X1,5	4,96
PFZNRG2LME1016	10L	16X1,5	5,64
PFZNRG2LME1018	10L	18X1,5	6,20
PFZNRG2LME1022	10L	22X1,5	6,33
PFZNRG2LME1214	12L	14X1,5	5,64
PFZNRG2LME1216	12L	16X1,5	5,64
PFZNRG2LME1218	12L	18X1,5	6,33
PFZNRG2LME1222	12L	22X1,5	6,33
PFZNRG2LME1516	15L	16X1,5	8,26
PFZNRG2LME1518	15L	18X1,5	8,26
PFZNRG2LME1522	15L	22X1,5	8,26
PFZNRG2LME1818	18L	18X1,5	8,95
PFZNRG2LME1822	18L	22X1,5	8,95

Ref.	Ø	Filetado	€
PFZNRG2LME2226	22L	26X1,5	12,39
PFZNRG2LME2833	28L	33X2	16,52
PFZNRG2LME3542	35L	42X2	30,28
PFZNRG2LME4248	42L	48X2	43,47
PFZNRG2SME0612	6S	12X1,5	3,11
PFZNRG2SME0814	8S	14X1,5	4,14
PFZNRG2SME1016	10S	16X1,5	4,35
PFZNRG2SME1218	12S	18X1,5	5,80
PFZNRG2SME1222	12S	22X1,5	6,73
PFZNRG2SME1420	14S	20X1,5	6,73
PFZNRG2SME1622	16S	22X1,5	8,28
PFZNRG2SME1624	16S	24X1,5	8,80
PFZNRG2SME2027	20S	27X2	12,42
PFZNRG2SME2527	25S	27X2	14,49
PFZNRG2SME2533	25S	33X2	14,49
PFZNRG2SME3042	30S	42X2	18,63
PFZNRG2SME3848	38S	48X2	28,98



**E6-M-ED**

**HEMBRA GIRATORIA ROSCA MACHO METRICO ED**  
SWIVEL CONNECTOR METRIC ED  
FEMELLE TOURNANTE FILETAGE MÂLE METRIQUE ED

Ref.	Ø	Filetado	€
PFZE6LME0610	6L	10X1,5	20,65
PFZE6LME0812	8L	12X1,5	22,72
PFZE6LME1014	10L	14X1,5	24,78
PFZE6LME1216	12L	16X1,5	28,22
PFZE6LME1518	15L	18X1,5	30,98
PFZE6LME1822	18L	22X1,5	35,79
PFZE6LME2226	22L	26X1,5	44,05
PFZE6LME2833	28L	33X2	63,32
PFZE6LME3542	35L	42X2	94,98
PFZE6LME4248	42L	48X2	128,02

Ref.	Ø	Filetado	€
PFZE6SME0612	6SM	12X1,5	4,72
PFZE6SME0814	8SM	14X1,5	6,40
PFZE6SME1016	10SM	16X1,5	6,96
PFZE6SME1218	12SM	18X1,5	7,20
PFZE6SME1420	14SM	20X1,5	7,51
PFZE6SME1622	16SM	22X1,5	8,07
PFZE6SME2027	20SM	27X2	10,81
PFZE6SME2533	25SM	33X2	15,28
PFZE6SME3042	30SM	42X2	28,32
PFZE6SME3848	38SM	48X2	33,29

**ORIENTABLE A TUBO**  
LOCKNUT ADJUSTABLE  
ORIENTABLE À TUBE

**CODO NO AJUSTABLE**  
NON ADJUSTABLE ELBOW  
COUDE NON RÉGLABLE



**W6R**

**CODO 90° ORIENTABLE BSP TUBO**  
90° BSP ADJUSTABLE ELBOW TUBE  
COUDE 90° ORIENTABLE BSP TUBE

Ref.	Ø	Threads	€
PFZNRW6LRE0602	6L	1/8	10,56
PFZNRW6LRE0804	8LR	1/4	10,76
PFZNRW6LRE1004	10L	1/4	11,87
PFZNRW6LRE1006	10L	3/8	12,35
PFZNRW6LRE1206	12L	3/8	13,11
PFZNRW6LRE1208	12L	1/2	15,73
PFZNRW6LRE1508	15L	1/2	16,28
PFZNRW6LRE1808	18L	1/2	20,21
PFZNRW6LRE2212	22L	3/4	26,22
PFZNRW6LRE2816	28L	1	41,89
PFZNRW6LRE3520	35L	1 1/4	79,70

Ref.	Ø	Threads	€
PFZNRW6LRE4224	42L	1 1/4	91,77
PFZNRW6SRE0604	6S	1/4	10,76
PFZNRW6SRE0804	8S	1/4	11,80
PFZNRW6SRE1006	10S	3/8	13,04
PFZNRW6SRE1206	12S	3/8	14,15
PFZNRW6SRE1408	14S	1/2	16,35
PFZNRW6SRE1608	16S	1/2	18,22
PFZNRW6SRE2012	20S	3/4	26,63
PFZNRW6SRE2516	25S	1	42,85
PFZNRW6SRE3020	30S	1 1/4	67,20
PFZNRW6SRE3824	38S	1 1/2	92,74



**W4-RT**

**CODO 90° MACHO BSPT TUBO**  
BSPT STUD 90° ELBOW  
COUDE 90° MÂLE BSPT TUBE

Ref.	Ø	Threads	€
PFZNRW4LRT0602	6L	1/8	3,93
PFZNRW4LRT0604	6L	1/4	5,12
PFZNRW4LRT0802	8L	1/8	5,69
PFZNRW4LRT0804	8L	1/4	5,07
PFZNRW4LRT0806	8L	3/8	7,35
PFZNRW4LRT0808	8L	1/2	8,22
PFZNRW4LRT1004	10L	1/4	5,66
PFZNRW4LRT1006	10L	3/8	7,35
PFZNRW4LRT1008	10L	1/2	8,23
PFZNRW4LRT1204	12L	1/4	7,45
PFZNRW4LRT1206	12L	3/8	7,62
PFZNRW4LRT1208	12L	1/2	8,94
PFZNRW4LRT1508	15L	1/2	9,16
PFZNRW4LRT1808	18L	1/2	11,64

Ref.	Ø	Threads	€
PFZNRW4LRT2212	22L	3/4	17,94
PFZNRW4LRT2816	28L	1	25,80
PFZNRW4LRT3520	35L	1 1/4	44,09
PFZNRW4LRT4224	42L	1 1/2	50,51
PFZNRW4SRT0604	6S	1/4	4,69
PFZNRW4SRT0804	8S	1/4	5,59
PFZNRW4SRT1006	10S	3/8	7,11
PFZNRW4SRT1206	12S	3/8	7,45
PFZNRW4SRT1408	14S	1/2	8,90
PFZNRW4SRT1608	16S	1/2	11,52
PFZNRW4SRT2012	20S	3/4	18,35
PFZNRW4SRT2516	25S	1	26,91
PFZNRW4SRT3020	30S	1 1/4	37,39
PFZNRW4SRT3824	38S	1 1/2	51,47

**BANJO TUBO**  
CODO BANJO BSP ED  
BSP BANJO ELBOW ED



**W5-R-ED**

**CODO BANJO BSP ED**  
BSP BANJO ELBOW ED  
COUDE BANJO BSP ED

Ref.	Ø	Threads	€
PFZNRW5LRE0602	6L	1/8	12,68
PFZNRW5LRE0804	8L	1/4	13,33
PFZNRW5LRE1004	10L	1/4	11,50
PFZNRW5LRE1206	12L	3/8	14,72
PFZNRW5LRE1508	15L	1/2	23,39
PFZNRW5LRE1808	18L	1/2	35,01
PFZNRW5LRE2212	22L	3/4	44,51
PFZNRW5LRE2816	28L	1	75,99
PFZNRW5LRE3520	35L	1 1/4	124,63
PFZNRW5LRE4224	42L	1 1/2	151,03

Ref.	Ø	Threads	€
PFZNRW5SRE0604	6S	1/4	14,08
PFZNRW5SRE0804	8S	1/4	15,18
PFZNRW5SRE1006	10S	3/8	18,14
PFZNRW5SRE1206	12S	3/8	22,15
PFZNRW5SRE1408	14S	1/2	23,46
PFZNRW5SRE1608	16S	1/2	28,15
PFZNRW5SRE2012	20S	3/4	36,02
PFZNRW5SRE2516	25S	1	61,76
PFZNRW5SRE3020	30S	1 1/4	124,72
PFZNRW5SRE3824	38S	1 1/2	152,23



**W4-NPT**

**CODO 90° MACHO NPT TUBO**  
NPT STUD 90° ELBOW  
COUDE 90° MÂLE NPT TUBE

Ref.	Ø	Threads	€
PFZNRW4LN0602	6L	1/8	4,92
PFZNRW4LN0604	6L	1/4	5,09
PFZNRW4LN0802	8L	1/8	4,69
PFZNRW4LN0804	8L	1/4	4,69
PFZNRW4LN1004	10L	1/4	5,66
PFZNRW4LN1006	10L	3/8	6,34
PFZNRW4LN1204	12L	1/4	7,17
PFZNRW4LN1206	12L	3/8	7,17
PFZNRW4LN1208	12L	1/2	7,52
PFZNRW4LN1508	15L	1/2	8,83
PFZNRW4LN1808	18L	1/2	13,32
PFZNRW4LN2212	22L	3/4	22,43
PFZNRW4LN2816	28L	1	32,26

Ref.	Ø	Threads	€
PFZNRW4LN3520	35L	1 1/4	55,1
PFZNRW4LN4224	42L	1 1/2	63,14
PFZNRW4SN0604	6S	1/4	5,87
PFZNRW4SN0804	8S	1/4	6,99
PFZNRW4SN1006	10S	3/8	8,88
PFZNRW4SN1206	12S	3/8	9,32
PFZNRW4SN1408	14S	1/2	11,13
PFZNRW4SN1608	16S	1/2	14,41
PFZNRW4SN2012	20S	3/4	22,95
PFZNRW4SN2516	25S	1	33,64
PFZNRW4SN3020	30S	1 1/4	46,75
PFZNRW4SN3824	35S	1 1/2	64,35

**TUBO A HEMBRA**  
TUBE TO FEMALE  
TUBE À FEMELLE



**L1R**

**TUBO A HEMBRA BSP**  
TUBE TO BSP FEMALE  
TUBE À FEMELLE BSP

Ref.	Ø	Ref.	Ø	€
PFZNRL1LR0602	6L	1/8		3,29
PFZNRL1LR0804	8L	1/4		3,93
PFZNRL1LR0806	8L	3/8		4,35
PFZNRL1LR0808	8L	1/2		7,33
PFZNRL1LR1004	10L	1/4		4,00
PFZNRL1LR1006	10L	3/8		4,76
PFZNRL1LR1008	10L	1/2		7,33
PFZNRL1LR1206	12L	3/8		5,49
PFZNRL1LR1208	12L	1/2		5,86
PFZNRL1LR1508	15L	1/2		7,33
PFZNRL1LR1808	18L	1/2		8,39
PFZNRL1LR2212	22L	3/4		12,94
PFZNRL1LR2816	28L	1		16,29
PFZNRL1LR3520	35L	1*1/4		50,93
PFZNRL1LR4224	42L	1*1/2		57,82
PFZNRL1SR0604	6S	1/4		4,40
PFZNRL1SR0804	8S	1/4		5,12
PFZNRL1SR1006	10S	3/8		7,14
PFZNRL1SR1206	12S	3/8		8,24
PFZNRL1SR1408	14S	1/2		7,33
PFZNRL1SR1608	16S	1/2		8,80
PFZNRL1SR2012	20S	3/4		13,22
PFZNRL1SR2516	25S	1		17,95
PFZNRL1SR3020	30S	1*1/4		54,93
PFZNRL1SR3824	38S	1*1/2		60,57



**L1M**

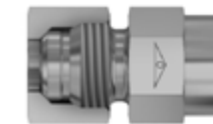

**MV-NR**

**TUBO A HEMBRA METRICA**  
TUBE TO METRIC FEMALE  
TUBE À FEMELLE METRIQUE

Ref.	Ø	Ref.	Ø	€
PFZNRL1LM0610	6L	10x100		4,82
PFZNRL1LM0812	8L	12x150		5,09
PFZNRL1LM1014	10L	14x150		5,50
PFZNRL1LM1216	12L	16x150		6,20
PFZNRL1LM1518	15L	18x150		9,64
PFZNRL1LM1822	18L	22x150		9,94
PFZNRL1LM2226	22L	26x250		11,71
PFZNRL1LM2833	28L	33x200		19,27
PFZNRL1LM3542	35L	42x200		54,93
PFZNRL1LM4248	42L	48x200		65,91
PFZNRL1SM0612	6S	12x150		5,23
PFZNRL1SM0814	8S	14x150		5,23
PFZNRL1SM1016	10S	16x150		7,71
PFZNRL1SM1218	12S	18x150		9,36
PFZNRL1SM1420	14S	20x150		9,63
PFZNRL1SM1622	16S	22x150		9,92
PFZNRL1SM2027	20S	27x200		14,86
PFZNRL1SM2533	25S	33x200		20,33
PFZNRL1SM3042	30S	42x200		54,93
PFZNRL1SM3848	38S	48x200		65,91

**ADAPTADOR MANOMETRO TUBO**  
PRESSURE GAUGE ADAPTER  
ADAPTATEUR POUR MANOMÈTRE À TUBE

Ref.	Ø	Ref.	Ø	€
PFZNRMLV0604	6L	1/4		5,38
PFZNRMLV0804	8L	1/4		5,59
PFZNRMLV1004	10L	1/4		6,90
PFZNRMLV1204	12L	1/4		7,45
PFZNRMVS0604	6S	1/4		5,59
PFZNRMVS0804	8S	1/4		6,83
PFZNRMVS1004	10S	1/4		7,38
PFZNRMVS1204	12S	1/4		10,22
PFZNRMVR04	L	1/4		1,86
PFZNRMVR08	S	1/2		2,28

**RACOR SIN TUERCA Y BICONO**  
**FITTING WITHOUT NUT AND RING**  
**RACCORD SANS ECROU ET BAGUE**

**UNIÓN TUBO TUBO**  
**TUBE TUBE UNION**  
**UNION TUBE TUBE**

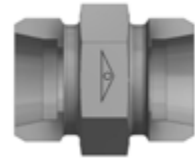

**G1**

**UNIÓN RECTO TUBO TUBO**  
**TUBE TUBE STRAIGHT UNION**  
**UNION DROIT TUBE TUBE**

Ref.	Ø	€
PFZG1L06	6L	1,45
PFZG1L08	8L	1,72
PFZG1L10	10L	1,86
PFZG1L12	12L	1,90
PFZG1L15	15L	2,89
PFZG1L18	18L	3,45
PFZG1L22	22L	5,23
PFZG1L28	28L	7,71
PFZG1L35	35L	12,67
PFZG1L42	42L	21,34

Ref.	Ø	€
PFZG1S06	6S	1,58
PFZG1S08	8S	2,20
PFZG1S10	10S	2,62
PFZG1S12	12S	2,71
PFZG1S14	14S	3,45
PFZG1S16	16S	3,85
PFZG1S20	20S	6,60
PFZG1S25	25S	10,18
PFZG1S30	30S	19,25
PFZG1S38	38S	26,15



**G1R**

**UNIÓN RECTO REDUCTOR TUBO TUBO**  
**TUBE TUBE REDUCER UNION**  
**UNION RÉDUCTEUR TUBE TUBE**

Ref.	Ø	€
PFZG1RL0806	8/6L	3,58
PFZG1RL1006	10/6L	2,20
PFZG1RL1008	10/8L	2,20
PFZG1RL1206	12/6L	2,34
PFZG1RL1208	12/8L	2,34
PFZG1RL1210	12/10L	2,34
PFZG1RL1510	15/10L	5,23
PFZG1RL1512	15/12L	5,23
PFZG1RL1810	18/10L	4,13
PFZG1RL1812	18/12L	7,85
PFZG1RL1815	18/15L	7,85
PFZG1RL2212	22/12L	13,08
PFZG1RL2215	22/15L	13,08
PFZG1RL2218	22/18L	8,95
PFZG1RL2818	28/18L	20,65
PFZG1RL2822	28/22L	43,50
PFZG1RL3522	35/22L	27,53
PFZG1RL3528	35/28L	13,48
PFZG1RS0806	8/6S	7,85

Ref.	Ø	€
PFZG1RS1006	10/6S	2,75
PFZG1RS1008	10/8S	2,75
PFZG1RS1206	12/6S	4,82
PFZG1RS1208	12/8S	4,82
PFZG1RS1210	12/10S	4,82
PFZG1RS1410	14/10S	4,82
PFZG1RS1412	14/12S	4,82
PFZG1RS1612	16/12S	4,13
PFZG1RS1614	16/14S	4,13
PFZG1RS2010	20/10S	7,85
PFZG1RS2012	20/12S	7,58
PFZG1RS2014	20/14S	7,58
PFZG1RS2016	20/16S	7,58
PFZG1RS2516	25/16S	8,95
PFZG1RS2520	25/20S	20,65
PFZG1RS3020	30/20S	43,50
PFZG1RS3025	30/25S	27,53
PFZG1RS3825	38/25S	15,28
PFZG1RS3830	38/30S	15,28



**B1**

**CUERPO RECTO PASATABIQUE TUBO TUBO**

TUBE TUBE BULKHEAD STRAIGHT  
DROIT PASSE-CLOISON TUBE TUBE

Ref.	Ø	€
PFZB1L06	6L	3,71
PFZB1L08	8L	4,41
PFZB1L10	10L	4,92
PFZB1L12	12L	6,09
PFZB1L15	15L	7,85
PFZB1L18	18L	10,60
PFZB1L22	22L	13,77
PFZB1L28	28L	20,65
PFZB1L35	35L	34,41
PFZB1L42	42L	47,61

Ref.	Ø	€
PFZB1S06	6S	5,51
PFZB1S08	8S	5,85
PFZB1S10	10S	7,02
PFZB1S12	12S	8,12
PFZB1S14	14S	10,00
PFZB1S16	16S	10,12
PFZB1S20	20S	17,90
PFZB1S25	25S	28,22
PFZB1S30	30S	37,17
PFZB1S38	38S	47,61



**W1**

**UNIÓN CODO 90° TUBO TUBO**

TUBE TUBE 90° UNION ELBOW  
UNION COUDE 90° TUBE TUBE

Ref.	Ø	€
PFZW1L06	6L	4,24
PFZW1L08	8L	5,38
PFZW1L10	10L	5,34
PFZW1L12	12L	6,44
PFZW1L15	15L	7,64
PFZW1L18	18L	12,50
PFZW1L22	22L	16,61
PFZW1L28	28L	22,25
PFZW1L35	35L	51,20
PFZW1L42	42L	60,93

Ref.	Ø	€
PFZW1S06	6S	6,09
PFZW1S08	8S	7,91
PFZW1S10	10S	8,38
PFZW1S12	12S	9,11
PFZW1S14	14S	9,54
PFZW1S16	16S	12,21
PFZW1S20	20S	17,13
PFZW1S25	25S	22,77
PFZW1S30	30S	29,08
PFZW1S38	38S	43,81



**T1**

**UNIÓN T TUBO TUBO**

TUBE TUBE T UNION  
UNION T TUBE TUBE

Ref.	Ø	€
PFZT1L06	6L	5,72
PFZT1L08	8L	6,73
PFZT1L10	10L	7,40
PFZT1L12	12L	8,07
PFZT1L15	15L	11,03
PFZT1L18	18L	16,51
PFZT1L22	22L	21,43
PFZT1L28	28L	28,35
PFZT1L35	35L	46,73
PFZT1L42	42L	57,59

Ref.	Ø	€
PFZT1S06	6S	6,05
PFZT1S08	8S	7,40
PFZT1S10	10S	8,07
PFZT1S12	12S	10,16
PFZT1S14	14S	12,25
PFZT1S16	16S	17,12
PFZT1S20	20S	23,92
PFZT1S25	25S	28,93
PFZT1S25	30S	38,35
PFZT1S38	38S	59,20

**TUBO A HEMBRA GIRATORIA**  
TUBE TO SWIVEL  
TUBE À FEMELLE TOURNANTE



**W2**

**CODO 90° HEMBRA GIRATORIA**  
90° ELBOW SWIVEL  
COUDE 90° FEMELLE TOURNANTE

Ref.	Ø	€
PFZW2L06	6L	6,91
PFZW2L08	8L	7,56
PFZW2L10	10L	8,30
PFZW2L12	12L	8,33
PFZW2L15	15L	10,92
PFZW2L18	18L	15,39
PFZW2L22	22L	21,42
PFZW2L28	28L	29,81
PFZW2L35	35L	52,90
PFZW2L42	42L	77,76

Ref.	Ø	€
PFZW2S06	6S	8,39
PFZW2S08	8S	8,80
PFZW2S10	10S	9,08
PFZW2S12	12S	9,11
PFZW2S14	14S	9,42
PFZW2S16	16S	14,72
PFZW2S20	20S	19,65
PFZW2S25	25S	35,30
PFZW2S30	30S	52,89
PFZW2S38	38S	67,62



**W3**

**CODO 45° HEMBRA GIRATORIA**  
45° ELBOW SWIVEL  
COUDE 45° FEMELLE TOURNANTE

Ref.	Ø	€
PFZW3L06	6L	5,69
PFZW3L08	8L	6,21
PFZW3L10	10L	7,16
PFZW3L12	12L	8,71
PFZW3L15	15L	9,49
PFZW3L18	18L	15,09
PFZW3L22	22L	23,81
PFZW3L28	28L	46,06
PFZW3L35	35L	63,48
PFZW3L42	42L	84,73

Ref.	Ø	€
PFZW3S06	6S	6,21
PFZW3S08	8S	7,16
PFZW3S10	10S	8,71
PFZW3S12	12S	9,14
PFZW3S16	16S	13,46
PFZW3S20	20S	23,81
PFZW3S25	25S	46,06
PFZW3S30	30S	55,55
PFZW3S38	38S	85,73



**T2**

**TE HEMBRA GIRATORIA CENTRAL**  
SWIVEL NUT BRANC TEE  
TE EMELLE TOURNANTE CENTRAL

Ref.	Ø	€
PFZT2L06	6L	7,73
PFZT2L08	8L	8,00
PFZT2L10	10L	10,01
PFZT2L12	12L	11,28
PFZT2L15	15L	13,38
PFZT2L18	18L	19,87
PFZT2L22	22L	25,67
PFZT2L28	28L	38,78
PFZT2L35	35L	82,59
PFZT2L42	42L	93,84

Ref.	Ø	€
PFZT2S06	6S	8,00
PFZT2S08	8S	10,01
PFZT2S10	10S	12,42
PFZT2S12	12S	12,83
PFZT2S14	14S	13,38
PFZT2S16	16S	17,52
PFZT2S20	20S	25,67
PFZT2S25	25S	38,78
PFZT2S30	30S	71,96
PFZT2S38	38S	93,84



**T4**

**TE HEMBRA GIRATORIA LATERAL**  
SWIVEL NUT RUN TEE  
TE FEMELLE TOURNANTE LATÉRALE

Ref.	Ø	€
PFZT4L06	6L	7,73
PFZT4L08	8L	8,00
PFZT4L10	10L	10,01
PFZT4L12	12L	11,28
PFZT4L15	15L	13,38
PFZT4L18	18L	19,87
PFZT4L22	22L	25,67
PFZT4L28	28L	38,78
PFZT4L35	35L	82,59
PFZT4L42	42L	93,84

Ref.	Ø	€
PFZT4S06	6S	8,00
PFZT4S08	8S	10,01
PFZT4S10	10S	12,42
PFZT4S12	12S	12,83
PFZT4S14	14S	13,38
PFZT4S16	16S	17,52
PFZT4S20	20S	25,67
PFZT4S25	25S	38,78
PFZT4S30	30S	71,96
PFZT4S38	38S	93,84



**KO**

**HEMBRA GIRATORIA A TUBO REDUCIDO**  
TUB END REDUCER  
RÉDUCTEUR FEMELLE TOURNANTE - TUBE

Ref.	Ø	€
PFZK0L0806	8/6L	4,14
PFZK0L1006	10/6L	4,35
PFZK0L1008	10/8L	4,35
PFZK0L1206	12/6L	4,66
PFZK0L1208	12/8L	4,66
PFZK0L1210	12/10L	4,66
PFZK0L1506	15/6L	5,18
PFZK0L1508	15/8L	5,18
PFZK0L1510	15/10L	5,18
PFZK0L1512	15/12L	5,18
PFZK0L1806	18/6L	12,42
PFZK0L1808	18/8L	12,42
PFZK0L1810	18/10L	7,25
PFZK0L1812	18/12L	7,25
PFZK0L1815	18/15L	9,32
PFZK0L2210	22/10L	16,52
PFZK0L2212	22/12L	16,52
PFZK0L2215	22/15L	16,52
PFZK0L2218	22/18L	16,52
PFZK0L2815	28/15L	22,02
PFZK0L2818	28/18L	22,02
PFZK0L2822	28/22L	22,02
PFZK0L3518	35/18L	41,30
PFZK0L3522	35/22L	27,53
PFZK0L3528	35/28L	27,53
PFZK0L4222	42/22L	55,06
PFZK0L4228	42/28L	55,06
PFZK0L4235	42/35L	48,18
PFZK0S0806	8/6S	19,27

Ref.	Ø	€
PFZK0S1006	10/6S	20,65
PFZK0S1008	10/8S	20,65
PFZK0S1206	12/6S	21,34
PFZK0S1208	12/8S	21,34
PFZK0S1210	12/10S	21,34
PFZK0S1410	14/10S	27,53
PFZK0S1412	14/12S	27,53
PFZK0S1606	16/6S	27,53
PFZK0S1608	16/8S	27,53
PFZK0S1610	16/10S	27,53
PFZK0S1612	16/12S	27,53
PFZK0S1614	16/14S	27,53
PFZK0S2008	20/8S	30,28
PFZK0S2010	20/10S	30,28
PFZK0S2012	20/12S	30,28
PFZK0S2014	20/14S	30,28
PFZK0S2016	20/16S	30,28
PFZK0S2510	25/10S	33,04
PFZK0S2512	25/12S	33,04
PFZK0S2514	25/14S	33,04
PFZK0S2516	25/16S	33,04
PFZK0S2520	25/20S	33,04
PFZK0S3016	30/16S	41,30
PFZK0S3020	30/20S	41,30
PFZK0S3025	30/25S	41,30
PFZK0S3816	38/16S	52,31
PFZK0S3820	38/20S	52,31
PFZK0S3825	38/25S	52,31

**RECTO MACHO**  
MALE STUD CONNECTOR  
DROIT MÂLE



**G2-R-ED**

**RECTO ROSCA BSP ED**

BSP MALE ED STUD CONNECTOR  
DROIT FILETAGE BSP ED

Ref.	Ø	Filetado	€
PFZG2LRE0602	6L	1/8	2,59
PFZG2LRE0604	6L	1/4	2,33
PFZG2LRE0804	8L	1/4	2,41
PFZG2LRE0806	8L	3/8	2,96
PFZG2LRE0808	8L	1/2	4,82
PFZG2LRE1004	10L	1/4	2,20
PFZG2LRE1006	10L	3/8	2,70
PFZG2LRE1008	10L	1/2	3,78
PFZG2LRE1204	12L	1/4	2,62
PFZG2LRE1206	12L	3/8	2,62
PFZG2LRE1208	12L	1/2	3,72
PFZG2LRE1506	15L	3/8	3,72
PFZG2LRE1508	15L	1/2	4,20
PFZG2LRE1512	15L	3/4	6,20
PFZG2LRE1808	18L	1/2	4,00
PFZG2LRE1812	18L	3/4	5,51
PFZG2LRE2208	22L	1/2	6,05
PFZG2LRE2212	22L	3/4	6,05
PFZG2LRE2812	28L	3/4	11,70
PFZG2LRE2816	28L	1	11,70
PFZG2LRE3516	35L	1	19,27
PFZG2LRE3520	35L	1" 1/4	19,27

**RECTO ROSCA MÉTRICA**

BSPT MALE STUD CONNECTOR  
DROIT FILETAGE BSPT



**G2-M-ED**

Ref.	Ø	Filetado	€
PFZG2LME0610	6L	10X1,5	2,33
PFZG2LME0812	8L	12X1,5	2,50
PFZG2LME0814	8L	14X1,5	2,50
PFZG2LME0816	8L	16X1,5	2,93
PFZG2LME1014	10L	14X1,5	2,93
PFZG2LME1016	10L	16X1,5	3,36
PFZG2LME1018	10L	18X1,5	3,96
PFZG2LME1022	10L	22X1,5	4,66
PFZG2LME1214	12L	14X1,5	3,36
PFZG2LME1216	12L	16X1,5	3,36
PFZG2LME1218	12L	18X1,5	3,96

Ref.	Ø	Filetado	€
PFZG2LRE4224	42L	1" 1/2	26,15
PFZG2SRE0604	6S	1/4	2,38
PFZG2SRE0804	8S	1/4	2,59
PFZG2SRE0806	8S	3/8	3,21
PFZG2SRE0808	8S	1/2	3,31
PFZG2SRE1004	10S	1/4	3,15
PFZG2SRE1006	10S	3/8	3,00
PFZG2SRE1204	12S	1/4	3,26
PFZG2SRE1206	12S	3/8	2,90
PFZG2SRE1208	12S	1/2	3,31
PFZG2SRE1408	14S	1/2	3,42
PFZG2SRE1606	16S	3/8	3,62
PFZG2SRE1608	16S	1/2	3,62
PFZG2SRE1612	16S	3/4	5,23
PFZG2SRE2008	20S	1/2	6,42
PFZG2SRE2012	20S	3/4	6,42
PFZG2SRE2016	20S	1	13,77
PFZG2SRE2512	25S	3/4	10,35
PFZG2SRE2516	25S	1	10,35
PFZG2SRE3016	30S	1	13,46
PFZG2SRE3020	30S	1" 1/4	13,46
PFZG2SRE3824	38S	1" 1/2	27,95

Ref.	Ø	Filetado	€
PFZG2LME1220	12L	20X1,5	4,66
PFZG2LME1222	12L	22X1,5	4,66
PFZG2LME1516	15L	16X1,5	4,66
PFZG2LME1518	15L	18X1,5	4,66
PFZG2LME1522	15L	22X1,5	4,66
PFZG2LME1818	18L	18X1,5	5,18
PFZG2LME1822	18L	22X1,5	5,18
PFZG2LME2226	22L	26X1,5	7,42
PFZG2LME2833	28L	33X1,5	12,24
PFZG2LME3542	35L	42X1,5	21,56
PFZG2LME4248	42L	48X1,5	27,77



**G2-RT**

**RECTO ROSCA BSPT**

BSPT MALE STUD CONNECTOR  
DROIT FILETAGE BSPT

Ref.	Ø	Filetado	€
PFZG2LRT0602	6L	1/8	1,66
PFZG2LRT0604	6L	1/4	2,59
PFZG2LRT0802	8L	1/8	2,28
PFZG2LRT0804	8L	1/4	2,28
PFZG2LRT0806	8L	3/8	2,90
PFZG2LRT0808	8L	1/2	4,76
PFZG2LRT1004	10L	1/4	3,09
PFZG2LRT1006	10L	3/8	4,13
PFZG2LRT1008	10L	1/2	5,23
PFZG2LRT1204	12L	1/4	2,59

Ref.	Ø	Filetado	€
PFZG2LRT1206	12L	3/8	3,00
PFZG2LRT1208	12L	1/2	4,66
PFZG2LRT1506	15L	3/8	3,58
PFZG2LRT1508	15L	1/2	3,58
PFZG2LRT1808	18L	1/2	4,26
PFZG2LRT2212	22L	3/4	6,11
PFZG2LRT2816	28L	1"	13,35
PFZG2LRT3520	35L	1" 1/4	20,93
PFZG2LRT4224	42L	1" 1/2	29,08



**G2-NPT**

**RECTO ROSCA NPT**

NPT MALE STUD CONNECTOR  
DROIT FILETAGE NPT

Ref.	Ø	Filetado	€
PFZG2LN0602	6L	1/8	23,39
PFZG2LN0604	6L	1/4	2,75
PFZG2LN0802	8L	1/8	2,75
PFZG2LN0804	8L	1/4	2,45
PFZG2LN0808	8L	1/2	5,23
PFZG2LN1004	10L	1/4	3,09
PFZG2LN1006	10L	3/8	5,23
PFZG2LN1008	10L	1/2	5,23
PFZG2LN1204	12L	1/4	4,66

Ref.	Ø	Filetado	€
PFZG2LN1206	12L	3/8	2,99
PFZG2LN1208	12L	1/2	3,03
PFZG2LN1506	15L	3/8	5,23
PFZG2LN1508	15L	1/2	5,79
PFZG2LN1808	18L	1/2	5,79
PFZG2LN2212	22L	3/4	8,26
PFZG2LN2816	28L	1"	12,39
PFZG2LN3520	35L	1" 1/4	20,18
PFZG2LN4224	42L	1" 1/2	28,98

**ORIENTABLE A TUBO**  
LOCKNUT ADJUSTABLE  
ORIENTABLE À TUBE

**CODO NO AJUSTABLE**  
NON ADJUSTABLE ELBOW  
COUDE NON RÉGLABLE



**W6-R**

**CODO 90° ORIENTABLE BSP TUBO**  
90° BSP ADJUSTABLE ELBOW TUBE  
COUDE 90° ORIENTABLE BSP TUBE

Ref.	Ø	Threads	€
PFZW6LRE0602	6L	1/8	9,59
PFZW6LRE0804	8L	1/4	9,59
PFZW6LRE1004	10L	1/4	10,42
PFZW6LRE1006	10L	3/8	10,90
PFZW6LRE1206	12L	3/8	11,46
PFZW6LRE1208	12L	1/2	14,08
PFZW6LRE1508	15L	1/2	14,08
PFZW6LRE1808	18L	1/2	17,05
PFZW6LRE2212	22L	3/4	21,87
PFZW6LRE2816	28L	1	36,30
PFZW6LRE3520	35L	1 1/4	71,96

Ref.	Ø	Threads	€
PFZW6LRE4224	42L	1 1/2	81,35
PFZW6SRE0604	6S	1/4	9,59
PFZW6SRE0804	8S	1/4	10,42
PFZW6SRE1006	10S	3/8	11,46
PFZW6SRE1206	12S	3/8	12,21
PFZW6SRE1408	14S	1/2	14,08
PFZW6SRE1608	16S	1/2	14,90
PFZW6SRE2012	20S	3/4	21,87
PFZW6SRE2516	25S	1	36,30
PFZW6SRE3020	30S	1 1/4	59,41
PFZW6SRE3824	38S	1 1/2	81,35



**W4-RT**

**CODO 90° MACHO BSPT TUBO**  
BSPT STUD 90° ELBOW  
COUDE 90° MÂLE BSPT TUBE

Ref.	Ø	Threads	€
PFZW4LRT0602	6L	1/8	3,71
PFZW4LRT0604	6L	1/4	3,88
PFZW4LRT0804	8L	1/4	4,40
PFZW4LRT0806	8L	3/8	6,13
PFZW4LRT1004	10L	1/4	5,26
PFZW4LRT1006	10L	3/8	6,13
PFZW4LRT1008	10L	1/2	7,07
PFZW4LRT1204	12L	1/4	6,90
PFZW4LRT1206	12L	3/8	6,90
PFZW4LRT1208	12L	1/2	7,33
PFZW4LRT1508	15L	1/2	8,28
PFZW4LRT1808	18L	1/2	13,97
PFZW4LRT2212	22L	3/4	16,99
PFZW4LRT2816	28L	1	25,27
PFZW4LRT3520	35L	1 1/4	45,46
PFZW4LRT4224	42L	1 1/2	50,11
PFZW4SRT0604	6S	1/4	4,40
PFZW4SRT0804	8S	1/4	5,26
PFZW4SRT1006	10S	3/8	6,90
PFZW4SRT1206	12S	3/8	6,90
PFZW4SRT1408	14S	1/2	8,28
PFZW4SRT1608	16S	1/2	10,27
PFZW4SRT2012	20S	3/4	16,99
PFZW4SRT2516	25S	1	25,44
PFZW4SRT3020	30S	1 1/4	37,00
PFZW4SRT3824	38S	1 1/2	50,11

**BANJO TUBO**  
BANJO FITTINGS  
BANJO



**W5-R**

**CODO BANJO BSP ED**  
BSP BANJO ELBOW ED  
COUDE BANJO BSP ED

Ref.	Ø	Threads	€
PFZW5LRE0602	6L	1/8	11,93
PFZW5LRE0804	8L	1/4	12,91
PFZW5LRE1004	10L	1/4	12,42
PFZW5LRE1206	12L	3/8	15,18
PFZW5LRE1508	15L	1/2	21,19
PFZW5LRE1808	18L	1/2	24,84
PFZW5LRE2212	22L	3/4	31,26
PFZW5LRE2816	28L	1	55,20
PFZW5LRE3520	35L	1 1/4	91,98
PFZW5LRE4224	42L	1 1/2	110,40

Ref.	Ø	Threads	€
PFZW5SRE0604	6S	1/4	12,91
PFZW5SRE0804	8S	1/4	13,80
PFZW5SRE1006	10S	3/8	16,56
PFZW5SRE1206	12S	3/8	20,21
PFZW5SRE1408	14S	1/2	21,19
PFZW5SRE1608	16S	1/2	24,84
PFZW5SRE2012	20S	3/4	31,26
PFZW5SRE2516	25S	1	55,20
PFZW5SRE3020	30S	1 1/4	91,98
PFZW5SRE3824	38S	1 1/2	110,40

**TUBO A HEMBRA**  
TUBE TO FEMALE  
TUBE À FEMELLE

**TAPONES**  
PLUGS  
BOUCHONS

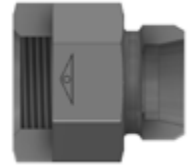

**L1R**

**TUBO A HEMBRA BSP**  
TUBE TO BSP FEMALE  
TUBE À FEMELLE BSP

Ref.	Ø		€
PFZL1LR0602	6L	1/8	2,47
PFZL1LR0804	8L	1/4	2,75
PFZL1LR0806	8L	3/8	3,03
PFZL1LR0808	8L	1/2	5,51
PFZL1LR1004	10L	1/4	3,03
PFZL1LR1006	10L	3/8	3,58
PFZL1LR1008	10L	1/2	5,51
PFZL1LR1206	12L	3/8	4,30

Ref.	Ø		€
PFZL1LR1208	12L	1/2	4,41
PFZL1LR1508	15L	1/2	5,51
PFZL1LR1808	18L	1/2	5,51
PFZL1LR2212	22L	3/4	9,42
PFZL1LR2816	28L	1	12,25
PFZL1LR3520	35L	1"1/4	38,30
PFZL1LR4224	42L	1"1/2	43,47

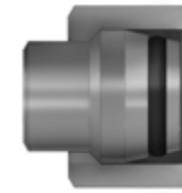

**P1**

**TAPON OBTURADOR CON TUERCA 24°**  
24° BLANKING PLUG WITH NUT  
BOUCHON OBTURATEUR 24° AVEC ÉCROU

Ref.	Ø	€
PFZP1L06	6L	1,29
PFZP1L08	8L	1,35
PFZP1L10	10L	1,66
PFZP1L12	12L	2,07
PFZP1L15	15L	2,79
PFZP1L18	18L	5,34
PFZP1L22	22L	6,11
PFZP1L28	28L	8,28
PFZP1L35	35L	13,25
PFZP1L42	42L	14,49

Ref.	Ø	€
PFZP1S06	6S	1,35
PFZP1S08	8S	1,66
PFZP1S10	10S	2,07
PFZP1S12	12S	2,48
PFZP1S14	14S	2,79
PFZP1S16	16S	4,04
PFZP1S20	20S	6,11
PFZP1S25	25S	8,28
PFZP1S30	30S	12,42
PFZP1S38	38S	13,25



**L1M**

**TUBO A HEMBRA METRICA**  
TUBE TO METRIC FEMALE  
TUBE À FEMELLE METRIQUE

Ref.	Ø	€
PFZL1LM0610	6L	3,62
PFZL1LM0812	8L	3,83
PFZL1LM1014	10L	4,13
PFZL1LM1216	12L	4,66
PFZL1LM1518	15L	7,25

Ref.	Ø	€
PFZL1LM1822	18L	7,47
PFZL1LM2226	22L	8,80
PFZL1LM2833	28L	14,49
PFZL1LM3542	35L	41,30
PFZL1LM4248	42L	49,56



**BZ**

**TAPON OBTURADOR 24°**  
24° BLANKING PLUG  
BOUCHON OBTURATEUR 24°

Ref.	Ø	€
PFZBZLS06	6LS	1,42
PFZBZLS08	8LS	1,42
PFZBZLS10	10LS	1,54
PFZBZLS12	12LS	1,6
PFZBZS14	14S	2,49
PFZBZL15	15L	2,06
PFZBZS16	16S	2,4
PFZBZL18	18L	2,5

Ref.	Ø	€
PFZBZS20	20S	4,35
PFZBZL22	22L	3,95
PFZBZS25	25S	5,4
PFZBZL28	28L	5,4
PFZBZS30	30S	8,45
PFZBZL35	35L	8,9
PFZBZS38	38S	10,77
PFZBZL42	42L	11,04

**TAPON MACHO 24°**

BLANKING MALE PLUG 24°  
BOUCHON MÂLE 24°



**P3**

Ref.	Ø	€
PFZP3L06	6L	0,62
PFZP3L08	8L	0,68
PFZP3L10	10L	0,75
PFZP3L12	12L	0,81
PFZP3L15	15L	1,18
PFZP3L18	18L	1,55
PFZP3L22	22L	2,48
PFZP3L28	28L	3,42
PFZP3L35	35L	6,09
PFZP3L42	42L	9,00

Ref.	Ø	€
PFZP3S06	6S	0,68
PFZP3S08	8S	0,75
PFZP3S10	10S	0,81
PFZP3S12	12S	0,99
PFZP3S14	14S	1,18
PFZP3S16	16S	1,43
PFZP3S20	20S	2,48
PFZP3S25	25S	3,42
PFZP3S30	30S	7,20
PFZP3S38	38S	9,00

**TAPON MACHO ALLEN BSP ED**

BSP ED MALE PLUG  
BOUCHON ALLEN BSP ED



**VST-R-ED**

Ref.	Ø	€
PFZVSTR02ED	1/8	2,78
PFZVSTR04ED	1/4	2,93
PFZVSTR06ED	3/8	3,67
PFZVSTR08ED	1/2	4,93

Ref.	Ø	€
PFZVSTR12ED	3/4	6,45
PFZVSTR16ED	1	13,98
PFZVSTR20ED	1"1/4	25,62
PFZVSTR24ED	1"1/2	32,19

**TAPON MACHO ALLEN METRICO ED**

METRIC ED MALE PLUG  
BOUCHON ALLEN METRIQUE ED



**VST-M-ED**

Ref.	Ø	€
PFZVSTM10ED	10X1	3,53
PFZVSTM12ED	12X1,5	4,60
PFZVSTM14ED	14X1,5	4,93
PFZVSTM16ED	16X1,5	6,10
PFZVSTM18ED	18X1,5	5,86
PFZVSTM20ED	20X1,5	5,72

Ref.	Ø	€
PFZVSTM22ED	22X1,5	8,53
PFZVSTM26ED	26X1,5	11,15
PFZVSTM27ED	27X2	9,77
PFZVSTM33ED	33X2	19,55
PFZVSTM42ED	42X2	32,19
PFZVSTM48ED	48X2	40,28

**VALVULAS ANTIRRETORNO TUBO TUBO**

TUBE TUBE CHECK VALVES  
TUBE TUBE VALVES ANTI-RETOURS



**CHD**

Ref.	Ø	€
PFZCHDL06	6L	30,12
PFZCHDL08	8L	32,29
PFZCHDL10	10L	34,47
PFZCHDL12	12L	40,37
PFZCHDL15	15L	46,26
PFZCHDL18	18L	49,52
PFZCHDL22	22L	63,50
PFZCHDL28	28L	86,11

Ref.	Ø	€
PFZCHDS06	6S	32,29
PFZCHDS08	8S	32,29
PFZCHDS10	10S	35,50
PFZCHDS12	12S	37,67
PFZCHDS14	14S	43,06
PFZCHDS16	16S	47,35
PFZCHDS20	20S	55,99
PFZCHDS25	25S	78,04

**VALVULAS ANTIRRETORNO BSP TUBO**

BSP TUBE CHECK VALVES  
BSP TUBE VALVES ANTI-RETOURS



**CHV-R-ED**

Ref.	Ø	Ø	€
PFZCHVL06	1/8	6L	30,12
PFZCHVL08	1/4	8L	32,29
PFZCHVL10	1/4	10L	34,47
PFZCHVL12	3/8	12L	40,37
PFZCHVL15	1/2	15L	46,26
PFZCHVL18	1/2	18L	49,52
PFZCHVL22	3/4	22L	63,50
PFZCHVL28	1	28L	86,11

Ref.	Ø	Ø	€
PFZCHVS06	1/4	6SR	32,29
PFZCHVS08	1/4	8SR	32,29
PFZCHVS10	3/8	10SR	35,50
PFZCHVS12	3/8	12SR	37,67
PFZCHVS14	1/2	14SR	43,06
PFZCHVS16	1/2	16SR	47,35
PFZCHVS20	3/4	20SR	55,99
PFZCHVS25	1	25SR	78,04

**VALVULAS ANTIRRETORNO TUBO BSP**

TUBE BSP CHECK VALVES  
TUBE BSP VALVES ANTI-RETOURS



**CHZ-R-ED**

Ref.	Ø	Ø	€
PFZCHZL06	6L	1/8	30,12
PFZCHZL08	8L	1/4	32,29
PFZCHZL10	10L	1/4	34,47
PFZCHZL12	12L	3/8	40,37
PFZCHZL15	15L	1/2	46,26
PFZCHZL18	18L	1/2	49,52
PFZCHZL22	22L	3/4	63,50
PFZCHZL28	28L	1	86,11

Ref.	Ø	Ø	€
PFZCHZS06	6S	1/4	32,29
PFZCHZS08	8S	1/4	32,29
PFZCHZS10	10S	3/8	35,50
PFZCHZS12	12S	3/8	37,67
PFZCHZS14	14S	1/2	43,06
PFZCHZS16	16S	1/2	47,35
PFZCHZS20	20S	3/4	55,99
PFZCHZS25	25S	1	78,04

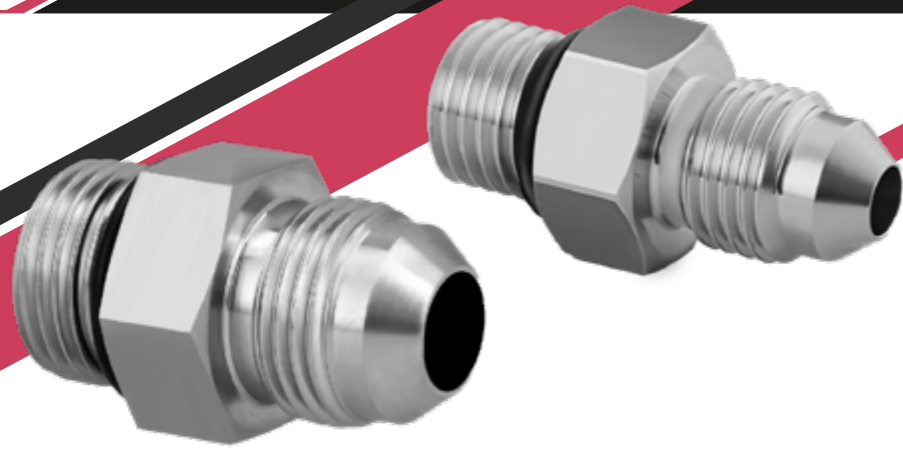

Los racores JIC/SAE Vincke están diseñados conforme a la normativa SAE J514. Utilizan una conexión cónica de 37° que proporciona un sellado metálico seguro y resistente, ideal para sistemas hidráulicos de media y alta presión.

Disponemos de una amplia gama y rápida disponibilidad, lo que nos permite responder de forma ágil a las necesidades del mercado industrial y de mantenimiento.

Vincke JIC/SAE adapters, built to SAE J514 standard, use a 37° flare design for secure metal-to-metal sealing in medium and high-pressure applications.

We offer a wide range with fast availability, ensuring quick response to industrial and maintenance demands.

*Les raccords JIC/SAE Vincke, conformes à la norme SAE J514, utilisent une connexion conique à 37° garantissant une étanchéité métallique fiable pour les systèmes sous moyenne et haute pression.*

*Disponibles en versions droites et coudées à 90°, en acier carbone avec revêtement anticorrosion ou acier inox AISI 316L. Gamme incluant modèles filetés, vissés et adaptateurs. Nous disposons d'une large gamme et d'une disponibilité rapide, pour répondre efficacement aux besoins industriels et de maintenance.*

## RACORES SAE JIC

### SAE JIC FITTINGS

### RACCORD SAE JIC

**RACORES SAE JIC**  
SAE JIC FITTINGS  
RACCORD SAE JIC

**TUERCAS Y FERULAS**  
NUTS & SLEEVES  
ÉCROUS ET FERRULES



**TUERCA SAE JIC**  
SAE JIC NUT  
ÉCROU JIC

Ref.		€
RAC070000004	7/16	1,16
RAC070000005	1/2	1,16
RAC070000006	9/16	1,21
RAC070000008	3/4	1,82
RAC070000010	7/8	2,06

Ref.		€
RAC070000012	1" 1/16	4,45
RAC070000016	1" 5/16	7,03
RAC070000020	1" 5/8	17,63
RAC070000024	1" 7/8	22,89

**FERULAS SAE JIC PARA TUBO PULGADAS**

SAE JIC SLEEVE FOR TUBE INCHES  
FERRULES JIC TUBE POUCES



Ref.	Ø	€
RAC070010004	7/16	0,47
RAC070010005	1/2	0,55
RAC070010006	9/16	1,00
RAC070010008	3/4	1,00
RAC070010010	7/8	1,27

Ref.	Ø	€
RAC070010012	1" 1/16	1,66
RAC070010016	1" 5/16	3,36
RAC070010020	1" 5/8	5,79
RAC070010024	1" 7/8	10,24

**FERULAS SAE JIC PARA TUBO MÉTRICO**

SAE JIC SLEEVE FOR METRIC TUBE  
FERRULES SAE JIC POUR TUBE MÉTRIQUE



Ref.	Ø	€
RAC070370406	6	1,48
RAC070370508	8	1,94
RAC070370610	10	2,02
RAC070370812	12	3,57

Ref.	Ø	€
RAC070371015	15	3,57
RAC070371016	16	1,56
RAC070371220	20	4,95
RAC070371625	25	5,37

**MACHO SOLDABLE SAE JIC**

SAE JIC WELDING MALE  
MÂLE À SOUDER SAE JIC



Ref.		€
RAC070020004	7/16	5,75
RAC070020005	1/2	2,38
RAC070020006	9/16	7,18
RAC070020008	3/4	10,07

Ref.		€
RAC070020010	7/8	10,21
RAC070020012	1" 1/16	6,20
RAC070020016	1" 5/16	12,58



**TAPÓN HEMBRA**  
FEMALE PLUG  
BOUCHON FEMELLE

Ref.		€
RAC070030004	7/16	2,47
RAC070030005	1/2	2,21
RAC070030006	9/16	2,15
RAC070030008	3/4	3,29
RAC070030010	7/8	4,44
RAC070030012	1" 1/16	7,38
RAC070030016	1" 5/16	11,61
RAC070030020	1" 5/8	24,39
RAC070030024	1" 7/8	51,75



**TAPÓN MACHO SAE JIC**  
SAE JIC MALE PLUG  
BOUCHONS MÂLE SAE JIC

Ref.		€
RAC070040004	7/16	2,01
RAC070040005	1/2	2,11
RAC070040006	9/16	2,20
RAC070040008	3/4	2,73
RAC070040010	7/8	3,91
RAC070040012	1" 1/16	6,18
RAC070040016	1" 5/16	8,38
RAC070040020	1" 5/8	21,82
RAC070040024	1" 7/8	24,16

**TAPONES**  
PLUGS  
BOUCHON

**RACOR RECTO**  
STRAIGHT FITTING  
RACOR DROIT



**PASATABIQUE SAE JIC CON TUERCA**  
SAE JIC BULKHEAD WITH NUT  
PASSE CLOISON SAE JIC AVEC ÉCROU

Ref.		€
RAC070050004	7/16	5,41
RAC070050005	1/2	5,76
RAC070050006	9/16	6,10
RAC070050008	3/4	7,43

Ref.		€
RAC070050010	7/8	10,19
RAC070050012	1" 1/16	12,02
RAC070050016	1" 5/16	20,49

**UNIÓN MACHO MACHO SAE JIC**  
SAE JIC MALE MALE UNION  
UNION MÂLE MÂLE SAE JIC



Ref.			€
RAC070070404	7/16	7/16	2,39
RAC070070505	1/2	1/2	3,32
RAC070070606	9/16	9/16	2,56
RAC070070808	3/4	3/4	2,88
RAC070071010	7/8	7/8	3,43

Ref.			€
RAC070071212	1" 1/16	1" 1/16	4,71
RAC070071616	1" 5/16	1" 5/16	10,65
RAC070072020	1" 5/8	1" 5/8	21,77
RAC070072424	1" 7/8	1" 7/8	28,22
RAC070073232	2" 1/2	2" 1/2	48,29

**UNIÓN MACHO-MACHO SAE JIC-BSPP**  
SAE JIC-BSPP MALE-MALE UNION  
UNION MÂLE -MÂLE SAE JIC BSPP



Ref.			€
RAC070080402	7/16	1/8	2,20
RAC070080404	7/16	1/4	2,92
RAC070080406	7/16	3/8	3,50
RAC070080408	7/16	1/2	5,62
RAC070080412	7/16	3/4	10,72
RAC070080504	1/2	1/4	3,36
RAC070080506	1/2	3/8	3,58
RAC070080604	9/16	1/4	2,97
RAC070080606	9/16	3/8	3,25
RAC070080608	9/16	1/2	4,99
RAC070080804	3/4	1/4	2,99
RAC070080806	3/4	3/8	3,15
RAC070080808	3/4	1/2	3,87
RAC070080812	3/4	3/4	6,20

Ref.			€
RAC070081006	7/8	3/8	3,82
RAC070081008	7/8	1/2	4,00
RAC070081012	7/8	3/4	6,38
RAC070081206	1" 1/16	3/8	5,94
RAC070081208	1" 1/16	1/2	4,80
RAC070081212	1" 1/16	3/4	5,96
RAC070081216	1" 1/16	1"	11,02
RAC070081612	1" 5/16	3/4	8,89
RAC070081616	1" 5/16	1"	10,92
RAC070081620	1" 5/16	1" 1/4	25,13
RAC070082016	1" 5/8	1"	28,74
RAC070082020	1" 5/8	1" 5/8	25,66
RAC070082020	1" 5/8	1" 1/4	35,10
RAC070082424	1" 7/8	1" 1/2	33,77



**UNIÓN MACHO-MACHO SAE JIC-UNF**  
SAE JIC-UNF MALE-MALE UNION  
UNION MÂL-MÂLE SAE JIC-UNF

Ref.			€
RAC070090404	7/16	7/16	2,69
RAC070090405	7/16	1/2	3,18
RAC070090406	7/16	9/16	2,83
RAC070090505	1/2	1/2	2,62
RAC070090606	9/16	9/16	2,53
RAC070090608	9/16	3/4	3,80
RAC070090808	3/4	3/4	2,89
RAC070090810	3/4	7/8	6,51
RAC070090812	3/4	1" 1/16	5,82
RAC070091006	7/8	9/16	4,55
RAC070091008	7/8	3/4	4,51
RAC070091010	7/8	7/8	77,41

Ref.			€
RAC070091012	7/8	1" 1/16	5,82
RAC070091208	1" 1/16	3/4	4,32
RAC070091210	1" 1/16	7/8	5,24
RAC070091212	1" 1/16	1" 1/16	5,82
RAC070091216	1" 1/16	1" 5/16	11,48
RAC070091612	1" 5/16	1" 1/16	12,17
RAC070091616	1" 5/16	1" 5/16	12,47
RAC070092016	1" 5/8	1" 5/16	23,42
RAC070092020	1" 5/8	1" 5/8	25,19
RAC070092024	1" 5/8	1" 7/8	28,03
RAC070092420	1" 7/8	1" 5/8	30,44
RAC070092424	1" 7/8	1" 7/8	36,21

**UNIÓN MACHO-MACHO SAE JIC-MÉTRICO**  
SAE JIC-MÉTRIC MALE-MALE UNION  
UNION MÂLE-MÂLE SAE JIC-MÉTRIQUE



Ref.			€
RAC070100410	7/16	10x100	5,49
RAC070100512	1/2	12x150	5,92
RAC070100614	9/16	14x150	5,56
RAC070100816	3/4	16x150	9,83
RAC070100818	3/4	18x150	7,14
RAC070100822	3/4	22x150	5,31
RAC070100826	3/4	26x150	12,97

Ref.			€
RAC070101018	7/8	18x150	13,52
RAC070101022	7/8	22x150	13,34
RAC070101218	1" 1/16	18x150	14,12
RAC070101222	1" 1/16	22x150	13,78
RAC070101226	1" 1/16	26x150	13,77
RAC070101626	1" 5/16	26x150	15,76

**UNIÓN MACHO-MACHO SAE JIC-NPTF**  
SAE JIC-NPTF MALE-MALE UNION  
UNION MÂLE-MÂLE SAE JIC-NPTF



Ref.			€
RAC070110402	7/16	1/8	2,72
RAC070110404	7/16	1/4	3,22
RAC070110502	1/2	1/8	2,73
RAC070110504	1/2	1/4	3,49
RAC070110602	9/16	1/8	3,32
RAC070110604	9/16	1/4	3,28
RAC070110606	9/16	3/8	3,59
RAC070110806	3/4	3/8	3,65

Ref.			€
RAC070110808	3/4	1/2	5,09
RAC070111006	7/8	3/8	8,01
RAC070111008	7/8	1/2	6,47
RAC070111208	1" 1/16	1/2	8,58
RAC070111212	1" 1/16	3/4	7,88
RAC070111612	1" 5/16	3/4	10,87
RAC070111616	1" 5/16	1"	10,82



**ADAPTADOR MACHO-HEMBRA GIRATORIA SAE JIC**  
MALE ADAPTER-SAE JIC SWIVEL FEMALE  
ADAPTATEUR MÂLE-FEMELLE TOURNANTE SAE JIC

Ref.			€
RAC070120404	7/16	7/16	5,82
RAC070120505	1/2	1/2	6,07
RAC070120606	9/16	9/16	7,37
RAC070120808	3/4	3/4	9,24
RAC070121010	7/8	7/8	8,44
RAC070121212	1" 1/16	1" 1/16	12,47
RAC070121616	1" 5/16	1" 5/16	26,26



**REDUCTOR HEMBRA GIRATORIA-MACHO SAE JIC**  
SWIVEL FEMALE REDUCER-SAE JIC MALE  
RÉDUCTEUR FEMELLE TOURNANTE-MÂLE SAE JIC

Ref.			€
RAC070130504	1/2	7/16	11,87
RAC070130604	9/16	7/16	6,30
RAC070130605	9/16	1/2	8,69
RAC070130804	3/4	7/16	4,09
RAC070130805	3/4	1/2	11,08
RAC070130806	3/4	9/16	12,55
RAC070131006	7/8	9/16	14,59
RAC070131008	7/8	3/4	7,68
RAC070131206	1" 1/16	9/16	15,72
RAC070131208	1" 1/16	3/4	21,34
RAC070131210	1" 1/16	7/8	13,04
RAC070131612	1" 5/16	1" 1/16	28,82
RAC070132012	1" 5/8	1" 1/16	14,81
RAC070132016	1" 5/8	1" 5/16	12,68
RAC070132420	1" 7/8	1" 5/8	21,06



**ADAPTADOR HEMBRA GIRATORIA-MACHO SAE JIC-BSPP**  
SWIVEL FEMALE ADAPTER -SAE JIC-BSPP MALE  
ADAPTATEUR FEMELLE TOURNANTE-MÂLE SAE JIC-BSPP

Ref.			€
RAC070140402	7/16	1/8	
RAC070140404	7/16	1/4	
RAC070140504	1/2	1/4	
RAC070140604	9/16	1/4	
RAC070140606	9/16	3/8	
RAC070140806	3/4	3/8	
RAC070140808	3/4	1/2	
RAC070141008	7/8	1/2	
RAC070141212	1" 1/16	3/4	
RAC070141612	1" 5/16	3/4	
RAC070141616	1" 5/16	1"	
RAC070142020	1" 5/8	1" 1/4	
RAC070142424	1" 7/8	1" 1/2	



**ADAPTADOR MACHO-HEMBRA FIJA SAE JIC-BSPP**  
MALE ADAPTER-SAE JIC-BSPP STUD FEMALE  
ADAPTATEUR MÂLE-FEMELLE FIXE JIC-BSPP

Ref.			€
RAC070150402	7/16	1/8	4,70
RAC070150404	7/16	1/4	5,55
RAC070150502	1/2	1/8	5,22
RAC070150504	1/2	1/4	4,70
RAC070150604	9/16	1/4	7,32
RAC070150606	9/16	3/8	6,38
RAC070150806	3/4	3/8	6,98
RAC070150808	3/4	1/2	8,83
RAC070151008	7/8	1/2	8,44
RAC070151208	1" 1/16	1/2	13,08
RAC070151212	1" 1/16	3/4	12,47
RAC070151616	1" 5/16	1"	23,54
RAC070152020	1" 5/8	1" 1/4	61,07
RAC070152424	1" 7/8	1" 1/2	67,30



**ADAPTADOR HEMBRA GIRATORIA-HEMBRA GIRATORIA SAE JIC**  
SWIVEL FEMALE ADAPTER-SAE JIC SWIVEL FEMALE  
ADAPTATEUR FEMELLE TOURNANTE-FEMELLE TOURNANTE SAE JIC

Ref.			€
RAC070160404	7/16	7/16	8,01
RAC070160505	1/2	1/2	6,28
RAC070160606	9/16	9/16	9,14
RAC070160808	3/4	3/4	12,42
RAC070161010	7/8	7/8	13,35
RAC070161212	1" 1/16	1" 1/16	20,94
RAC070161616	1" 5/16	1" 5/16	30,60



**TUERCA PASATABIQUE SAE JIC**  
SAE JIC BULKHEAD NUT  
ÉCROU PASSE CLOISON SAE JIC

Ref.		€
RAC070060004	7/16	1,80
RAC070060005	5/16	2,17
RAC070060006	9/16	2,82
RAC070060008	3/4	1,57
RAC070060010	7/8	2,53
RAC070060012	1" 1/16	4,71
RAC070060016	1" 5/16	7,77

**CODO 90°**  
90° ELBOW  
COUDE 90°



**CODO 90° MACHO FIJO-MACHO FIJO SAE JIC**  
90° ELBOW STUD MALE -SAE JIC STUD MALE  
COUDE 90° MÂLE FIXE-MÂLE FIXE SAE JIC

Ref.			€
RAC070170404	7/16	7/16	6,56
RAC070170505	1/2	1/2	7,68
RAC070170606	9/16	9/16	6,61
RAC070170808	3/4	3/4	13,73
RAC070171010	7/8	7/8	13,83

Ref.			€
RAC070171212	1" 1/16	1" 1/16	11,27
RAC070171616	1" 5/16	1" 5/16	33,28
RAC070172020	1" 5/8	1" 5/8	52,66
RAC070172424	1" 7/8	1" 7/8	88,29



**CODO 90° MACHO FIJO SAE JIC-MACHO FIJO NPTF**  
SAE JIC STUD MALE 90° ELBOW-NPTF STUD MALE  
COUDE 90° MÂLE FIXE SAE JIC-MÂLE FIXE NPTF

Ref.			€
RAC070200402	7/16	1/8	8,64
RAC070200404	7/16	1/4	7,22
RAC070200502	1/2	1/8	7,43
RAC070200504	1/2	1/4	7,22
RAC070200602	9/16	1/8	7,43
RAC070200604	9/16	1/4	7,22
RAC070200606	9/16	3/8	8,23
RAC070200806	3/4	3/8	8,23

Ref.			€
RAC070200808	3/4	1/2	10,74
RAC070201006	7/8	3/8	12,58
RAC070201008	7/8	1/2	12,42
RAC070201212	1" 1/16	3/4	16,70
RAC070201612	1" 5/16	3/4	33,68
RAC070201616	1" 5/16	1"	33,67
RAC070202020	1" 5/8	1" 1/4	66,74



**CODO 90° MACHO FIJO SAE JIC-MACHO ORIENTABLE BSPP**  
SAE JIC STUD MALE 90° ELBOW-BSPP ADJUSTABLE MALE  
COUDE 90° MÂLE FIXE SAE JIC-MÂLE ORIENTABLE BSPP

Ref.			€
RAC070180402	7/16	1/8	8,74
RAC070180404	7/16	1/4	10,84
RAC070180502	1/2	1/8	17,81
RAC070180504	1/2	1/4	10,92
RAC070180604	9/16	1/4	8,77
RAC070180606	9/16	3/8	10,74
RAC070180804	3/4	1/4	10,40
RAC070180806	3/4	3/8	10,69
RAC070180808	3/4	1/2	13,27
RAC070181006	7/8	3/8	14,89

Ref.			€
RAC070181008	7/8	1/2	13,27
RAC070181012	7/8	3/4	19,80
RAC070181208	1" 1/16	1/2	19,70
RAC070181212	1" 1/16	3/4	20,79
RAC070181612	1" 5/16	3/4	45,54
RAC070181616	1" 5/16	1"	35,19
RAC070181620	1" 5/16	1" 1/4	83,00
RAC070182016	1" 5/8	1"	52,43
RAC070182020	1" 5/8	1" 1/4	64,19



**CODO 90° PASATABIQUE MACHO FIJO-MACHO FIJO SAE JIC**  
BULKHEAD STUD MALE 90° ELBOW -SAE JIC STUD MALE  
COUDE 90° PASSE CLOISON MÂLE FIXE-MÂLE FIXE SAE JIC

Ref.			€
RAC070210404	7/16	7/16	26,41
RAC070210505	1/2	1/2	16,56
RAC070210606	9/16	9/16	13,42
RAC070210808	3/4	3/4	15,01

Ref.			€
RAC070211010	7/8	7/8	37,00
RAC070211212	1" 1/16	1" 1/16	32,76
RAC070211616	1" 5/16	1" 5/16	59,47



**CODO 90° MACHO FIJO SAE JIC-MACHO ORIENTABLE UNF**  
SAE JIC STUD MALE 90° ELBOW-UNF ADJUSTABLE MALE  
COUDE 90° MÂLE FIXE SAE JIC-MÂLE ORIENTABLE UNF

Ref.			€
RAC070190404	7/16	7/16	8,44
RAC070190505	1/2	1/2	13,08
RAC070190606	9/16	9/16	8,58
RAC070190808	3/4	3/4	19,49
RAC070190810	3/4	7/8	16,16
RAC070191010	7/8	7/8	14,54
RAC070191012	7/8	1" 1/16	20,21

Ref.			€
RAC070191210	1" 1/16	7/8	24,29
RAC070191212	1" 1/16	1" 1/16	19,46
RAC070191612	1" 5/16	1" 1/16	35,13
RAC070191616	1" 5/16	1" 5/16	35,55
RAC070192020	1" 5/8	1" 5/8	73,99
RAC070192424	1" 7/8	1" 7/8	122,57



**CODO 90° HEMBRA GIRATORIA-MACHO FIJO SAE JIC**  
SWIVEL FEMALE 90° ELBOW- SAE JIC STUD MALE  
COUDE 90° FEMELLE TOURNANTE-MÂLE FIXE SAE JIC

Ref.			€
RAC070220404	7/16	7/16	7,53
RAC070220505	1/2	1/2	9,60
RAC070220606	9/16	9/16	7,24
RAC070220808	3/4	3/4	9,35
RAC070221010	7/8	7/8	10,04

Ref.			€
RAC070221212	1" 1/16	1" 1/16	16,85
RAC070221616	1" 5/16	1" 5/16	32,92
RAC070222020	1" 5/8	1" 5/8	73,21
RAC070222424	1" 7/8	1" 7/8	160,09

**CODO 45°**  
45° ELBOW  
COUDE 45



**CODO 45° MACHO FIJO SAE JIC-MACHO ORIENTABLE BSPP**  
SAE JIC STUD MALE 45° ELBOW-BSPP ADJUSTABLE MALE  
COUDE 45° MÂLE FIXE SAE JIC-MÂLE ORIENTABLE BSPP

Ref.	1/16	1/8	€
RAC070240402	7/16	1/8	27,87
RAC070240404	7/16	1/4	17,87
RAC070240504	1/2	1/4	17,87
RAC070240604	9/16	1/4	19,08
RAC070240606	9/16	3/8	21,70
RAC070240804	3/4	1/4	30,51
RAC070240806	3/4	3/8	20,33
RAC070240808	3/4	1/2	26,55
RAC070241006	7/8	3/8	26,40
RAC070241008	7/8	1/2	26,55
RAC070241012	7/8	3/4	36,78
RAC070241208	1" 1/16	1/2	36,62
RAC070241212	1" 1/16	3/4	36,78
RAC070241612	1" 5/16	3/4	73,21
RAC070241616	1" 5/16	1"	73,21
RAC070241620	1" 5/16	1" 1/4	186,12
RAC070242016	1" 5/8	1"	174,26
RAC070242020	1" 5/8	1" 1/4	186,12

**CODO 45° MACHO FIJO SAE JIC-MACHO ORIENTABLE UNF**  
SAE JIC STUD MALE 45° ELBOW-UNF ADJUSTABLE MALE  
COUDE 45° MÂLE FIXE SAE JIC-MÂLE ORIENTABLE UNF



Ref.	1/16	1/8	€
RAC070250404	7/16	7/16	17,71
RAC070250505	1/2	1/2	17,91
RAC070250606	9/16	9/16	19,03
RAC070250808	3/4	3/4	23,65
RAC070251010	7/8	7/8	30,69
RAC070251212	1" 1/16	1" 1/16	42,80
RAC070251616	1" 5/16	1" 5/16	73,99

**CODO 45° MACHO FIJO SAE JIC-MACHO FIJO NPTF**  
SAE JIC STUD MALE 45° ELBOW-NPTF STUD MALE  
COUDE 45° MÂLE FIXE SAE JIC-MÂLE FIXE NPTF



Ref.	1/16	1/8	€
RAC070260402	7/16	1/8	8,85
RAC070260404	7/16	1/4	8,58
RAC070260502	1/2	1/8	13,97
RAC070260504	1/2	1/4	10,76
RAC070260602	9/16	1/8	18,46
RAC070260604	9/16	1/4	10,25
RAC070260606	9/16	3/8	11,29
RAC070260806	3/4	3/8	16,46
RAC070260808	3/4	1/2	16,88
RAC070261008	7/8	1/2	20,16
RAC070261212	1" 1/16	3/4	25,86
RAC070261616	1" 5/16	1"	33,62



**CODO 45° MACHO FIJO-HEMBRA GIRATORIA SAE JIC**  
SAE JIC STUD MALE 45° ELBOW-SAE JIC SWIVEL FEMALE  
COUDE 45° MÂLE FIXE-FEMELLE TOURNANTE SAE JIC

Ref.	1/16	1/8	€
RAC070270404	7/16	7/16	13,28
RAC070270505	1/2	1/2	13,39
RAC070270606	9/16	9/16	13,28
RAC070270808	3/4	3/4	16,65
RAC070271010	7/8	7/8	25,09
RAC070271212	1" 1/16	1" 1/16	27,89
RAC070271616	1" 5/16	1" 5/16	65,23
RAC070272020	1" 5/8	1" 5/8	99,03

**RACOR "T"**  
"T" FITTING  
RACCORD "T"



**T MACHO FIJO-MACHO FIJO-MACHO FIJO SAE JIC**  
T MALE STUD-MALE STUD-SAE JIC MALE STUD  
T MÂLE FIXE-MÂLE FIXE-MÂLE FIXE SAE JIC

Ref.	1/16	€
RAC070280404	7/16	8,94
RAC070280505	1/2	11,47
RAC070280606	9/16	13,24
RAC070280808	3/4	16,87
RAC070281010	7/8	15,19
RAC070281212	1" 1/16	20,97
RAC070281616	1" 5/16	46,70
RAC070282020	1" 5/8	93,08



**T MACHO FIJO-MACHO FIJO SAE JIC-MACHO ORIENTABLE BSPP**  
T SAE JIC MALE STUD -MALE STUD- SAE JIC ADJUSTABLE MALE  
T MÂLE FIXE-MÂLE FIXE SAE JIC-MÂLE ORIENTABLE BSPP

Ref.	1/16	1/8	€
RAC070290402	7/16	1/8	15,59
RAC070290502	1/2	1/8	16,52
RAC070290604	9/16	1/4	32,35
RAC070290806	3/4	3/8	28,92
RAC070291008	7/8	1/2	18,69
RAC070291212	1" 1/16	3/4	23,42
RAC070291616	1" 5/16	1"	35,98



**T MACHO FIJO-MACHO FIJO SAE JIC-MACHO ORIENTABLE BSPP CENTRAL**  
T MALE STUD- SAE JIC MALE STUD- BSPP CENTRAL ADJUSTABLE MALE  
T MÂLE FIXE- MÂLE FIXE SAE JIC-MÂLE ORIENTABLE BSPP CENTRAL

Ref.	1/16	1/8	€
RAC070300402	7/16	1/8	12,48
RAC070300502	1/2	1/8	10,50
RAC070300604	9/16	1/4	21,40
RAC070300606	9/16	3/8	16,68
RAC070300806	3/4	3/8	24,10
RAC070301008	7/8	1/2	22,96
RAC070301208	1" 1/16	1/2	26,51
RAC070301212	1" 1/16	3/4	50,29
RAC070301616	1" 5/16	1"	68,02

**T MACHO FIJO-MACHO FIJO-HEMBRA GIRATORIA SAE JIC**

T STUD MALE- STUD MALE-SAE JIC SWIVEL FEMALE  
T MÂLE FIXE- MÂLE FIXE- FEMELLE TOURNANTE SAE JIC



Ref.		€
RAC070310404	7/16	10,04
RAC070310505	1/2	13,27
RAC070310606	9/16	15,11
RAC070310808	3/4	13,49
RAC070311010	7/8	17,84
RAC070311212	1" 1/16	28,32
RAC070311616	1" 5/16	46,98
RAC070312020	1" 5/8	102,48

**T MACHO FIJO-HEMBRA GIRATORIA-MACHO FIJO SAE JIC**

T STUD MALE-SWIVEL FEMALE-SAE JIC STUD MALE  
T MÂLE FIXE-FEMELLE TOURNANTE-MÂLE FIXE SAE JIC



Ref.		€
RAC070320404	7/16	9,76
RAC070320505	1/2	11,82
RAC070320606	9/16	9,86
RAC070320808	3/4	14,84
RAC070321010	7/8	18,24
RAC070321212	1" 1/16	29,40
RAC070321616	1" 5/16	56,76
RAC070322020	1" 5/8	112,83

**T MACHO FIJO-MACHO FIJO SAE JIC-MACHO ORIENTABLE UNF**

T SAE JIC STUD MALE-STUD MALE-UNF ADJUSTABLE MALE  
T MÂLE FIXE-MÂLE FIXE SAE JIC-MÂLE ORIENTABLE UNF



Ref.			€
RAC070330404	7/16	7/16	18,33
RAC070330505	1/2	1/2	18,50
RAC070330606	9/16	9/16	18,33
RAC070330808	3/4	3/4	24,60
RAC070331010	7/8	7/8	31,88
RAC070331212	1" 1/16	1" 1/16	60,14
RAC070331616	1" 5/16	1" 5/16	50,39

**T MACHO FIJO-MACHO FIJO SAE JIC -MACHO ORIENTABLE UNF CENTRAL**

T SAE JIC STUD MALE-STUD MALE- CENTRAL UNF ADJUSTABLE MALE  
T MÂLE FIXE-MÂLE FIXE SAE JIC-MÂLE ORIENTABLE UNF CENTRAL



Ref.			€
RAC070340404	7/16	7/16	18,33
RAC070340505	1/2	1/2	18,50
RAC070340606	9/16	9/16	27,07
RAC070340808	3/4	3/4	28,29
RAC070341010	7/8	7/8	28,49
RAC070341212	1" 1/16	1" 1/16	37,82
RAC070341616	1" 5/16	1" 5/16	50,39

**¡GRACIAS POR CONFIAR EN NOSOTROS!  
PARA VINCKE ERES LO MÁS IMPORTANTE.**

**THANK YOU FOR YOUR TRUST!  
FOR VINCKE YOU ARE THE  
MOST IMPORTANT.**

**MERCI DE NOUS FAIRE CONFIANCE!  
POUR VINCKE, VOUS ÊTES  
LE PLUS IMPORTANT.**

**ABRAZADERAS VINCKE**  
VINCKE CLAMPS  
COLLIERS VINCKE

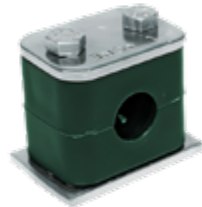

**ABRAZADERAS POLIPROPILENO SIMPLE SERIE LIGERA COMPLETA**  
SINGLE POLYPROPYLENE CLAMPS LIGHT SERIES COMPLET  
COLLIERS POLYPROPYLENE SIMPLE SÉRIE LÉGÈRE COMPLET

Ref.	Ø	Type	€
RAASLPP0106C	6	Gr. 1	2,29
RAASLPP0108C	8	Gr. 1	2,29
RAASLPP0110C	10	Gr. 1	2,29
RAASLPP0112C	12	Gr. 1	2,29
RAASLPP0212C	12,7	Gr. 2	2,37
RAASLPP0213C	13,5	Gr. 2	2,37
RAASLPP0214C	14	Gr. 2	2,37
RAASLPP0215C	15	Gr. 2	2,37
RAASLPP0216C	16	Gr. 2	2,37
RAASLPP0217C	17,2	Gr. 2	2,37
RAASLPP0218C	18	Gr. 2	2,37
RAASLPP0319C	19	Gr. 3	2,74
RAASLPP0320C	20	Gr. 3	2,65
RAASLPP0321C	21	Gr. 3	2,74
RAASLPP0322C	22	Gr. 3	2,65

Ref.	Ø	Type	€
RAASLPP0323C	23	Gr. 3	2,74
RAASLPP0325C	25	Gr. 3	2,74
RAASLPP0426C	26,9	Gr. 4	3,29
RAASLPP0428C	28	Gr. 4	3,29
RAASLPP0430C	30	Gr. 4	3,29
RAASLPP0532C	32	Gr. 5	4,21
RAASLPP0533C	33,7	Gr. 5	4,21
RAASLPP0535C	35	Gr. 5	4,21
RAASLPP0538C	38	Gr. 5	4,21
RAASLPP0540C	40	Gr. 5	4,21
RAASLPP0542C	42	Gr. 5	4,21
RAASLPP0644C	44,5	Gr. 6	5,52
RAASLPP0648C	48,3	Gr. 6	5,52
RAASLPP0650C	50,8	Gr. 6	5,52

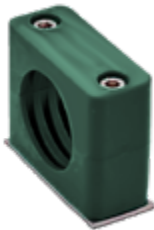

**ABRAZADERAS POLIPROPILENO SIMPLE SERIE LIGERA**  
SINGLE POLYPROPYLENE CLAMPS LIGHT SERIES  
COLLIERS POLYPROPYLENE SIMPLE SÉRIE LÉGÈRE

Ref.	Ø	Type	€
RAASLPP0106S	6	Gr. 1	1,93
RAASLPP0108S	8	Gr. 1	1,93
RAASLPP0110S	10	Gr. 1	1,93
RAASLPP0112S	12	Gr. 1	1,93
RAASLPP0212S	12,7	Gr. 2	2,05
RAASLPP0213S	13,5	Gr. 2	2,05
RAASLPP0214S	14	Gr. 2	2,05
RAASLPP0215S	15	Gr. 2	2,05
RAASLPP0216S	16	Gr. 2	2,05
RAASLPP0217S	17,2	Gr. 2	2,05
RAASLPP0218S	18	Gr. 2	2,05
RAASLPP0319S	19	Gr. 3	2,40
RAASLPP0320S	20	Gr. 3	2,40
RAASLPP0321S	21	Gr. 3	2,40
RAASLPP0322S	22	Gr. 3	2,40

Ref.	Ø	Type	€
RAASLPP0323S	23	Gr. 3	2,40
RAASLPP0325S	25	Gr. 3	2,40
RAASLPP0426S	26,9	Gr. 4	2,93
RAASLPP0428S	28	Gr. 4	2,93
RAASLPP0430S	30	Gr. 4	2,93
RAASLPP0532S	32	Gr. 5	2,93
RAASLPP0533S	33,7	Gr. 5	2,93
RAASLPP0535S	35	Gr. 5	2,93
RAASLPP0538S	38	Gr. 5	2,93
RAASLPP0540S	40	Gr. 5	2,93
RAASLPP0542S	42	Gr. 5	2,93
RAASLPP0644S	44,5	Gr. 6	4,97
RAASLPP0648S	48,3	Gr. 6	4,97
RAASLPP0650S	50,8	Gr. 6	4,97



**ABRAZADERAS POLIPROPILENO DOBLE SERIE LIGERA COMPLETA**  
DOUBLE POLYPROPYLENE CLAMPS LIGHT SERIES COMPLET  
COLLIERS POLYPROPYLENE DOBLE SÉRIE LÉGÈRE COMPLET

Ref.	Ø	Type	€
RAASDPP0106C	6	Gr. 1	2,84
RAASDPP0108C	8	Gr. 1	3,01
RAASDPP0110C	10	Gr. 1	3,11
RAASDPP0112C	12	Gr. 1	3,11
RAASDPP0212C	12,7	Gr. 2	3,87
RAASDPP0213C	13,5	Gr. 2	3,87
RAASDPP0214C	14	Gr. 2	3,87
RAASDPP0215C	15	Gr. 2	3,87
RAASDPP0216C	16	Gr. 2	3,87
RAASDPP0217C	17,2	Gr. 2	3,87
RAASDPP0218C	18	Gr. 2	3,87
RAASDPP0319C	19	Gr. 3	5,02

Ref.	Ø	Type	€
RAASDPP0320C	20	Gr. 3	5,02
RAASDPP0321C	21	Gr. 3	5,02
RAASDPP0322C	22	Gr. 3	5,02
RAASDPP0323C	23	Gr. 3	5,02
RAASDPP0325C	25	Gr. 3	5,02
RAASDPP0426C	26,9	Gr. 4	5,72
RAASDPP0428C	28	Gr. 4	5,72
RAASDPP0430C	30	Gr. 4	5,72
RAASDPP0533C	33	Gr. 5	7,12
RAASDPP0535C	35	Gr. 5	7,12
RAASDPP0538C	38	Gr. 5	7,12
RAASDPP0542C	42	Gr. 5	7,12



**ABRAZADERAS POLIPROPILENO SIMPLE SERIE PESADA COMPLETA**  
SINGLE POLYPROPYLENE CLAMPS HEAVY SERIES COMPLET  
COLLIERS POLYPROPYLENE SIMPLE SÉRIE LOURDE COMPLET

Ref.	Ø	Type	€
RAASPPP0106C	6	Gr. 1	6,98
RAASPPP0108C	8	Gr. 1	6,98
RAASPPP0110C	10	Gr. 1	6,98
RAASPPP0112C	12	Gr. 1	6,98
RAASPPP0114C	14	Gr. 1	6,98
RAASPPP0116C	16	Gr. 1	6,98
RAASPPP0118C	18	Gr. 1	6,98
RAASPPP0220C	20	Gr. 2	8,37
RAASPPP0221C	21	Gr. 2	8,37
RAASPPP0222C	22	Gr. 2	8,37
RAASPPP0225C	25	Gr. 2	8,37
RAASPPP0226C	26,7	Gr. 2	8,37
RAASPPP0228C	28	Gr. 2	8,37
RAASPPP0230C	30	Gr. 2	8,62
RAASPPP0330C	30	Gr. 3	8,62
RAASPPP0333C	33,7	Gr. 3	22,78
RAASPPP0338C	38	Gr. 3	22,78
RAASPPP0342C	42	Gr. 3	22,78

Ref.	Ø	Type	€
RAASPPP0438C	38	Gr. 4	22,78
RAASPPP0442C	42	Gr. 4	22,78
RAASPPP0448C	48,3	Gr. 4	22,78
RAASPPP0450C	50	Gr. 4	22,78
RAASPPP0455C	55	Gr. 4	22,78
RAASPPP0460C	60	Gr. 4	22,78
RAASPPP0463C	63	Gr. 4	22,78
RAASPPP0465C	65	Gr. 4	22,78
RAASPPP0570C	70	Gr. 5	40,06
RAASPPP0575C	75	Gr. 5	40,06
RAASPPP0576C	76	Gr. 5	40,06
RAASPPP0580C	80	Gr. 5	40,06
RAASPPP0588C	88	Gr. 5	40,06
RAASPPP06101C	101	Gr. 6	128,89
RAASPPP06106C	106	Gr. 6	128,89
RAASPPP06114C	114	Gr. 6	128,89
RAASPPP07139C	139	Gr. 7	182,50

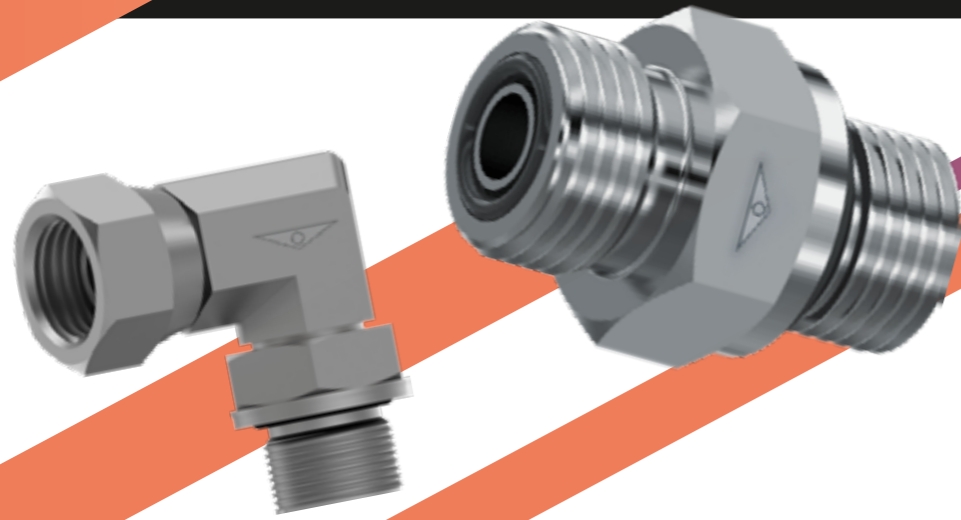

En adaptadores Vincke encontrarás una completa gama en adaptadores BSPP, soldable, mecanizado y estampado. Accesorios ORFS, bridas SAE y estanqueidad.

In Vincke adapters you will find a complete range of BSPP, weldable, machined and pressed adaptors. ORFS adaptors, SAE flanges and seals.

*Dans les adaptateurs Vincke, vous trouverez une gamme complète d'adaptateurs BSPP, de soudage, d'usinage et d'emboutissage. Accessoires ORFS, brides et joints SAE*

## ADAPTADORES VINCKE

## VINCKE ADAPTERS ADAPTEURS VINCKE



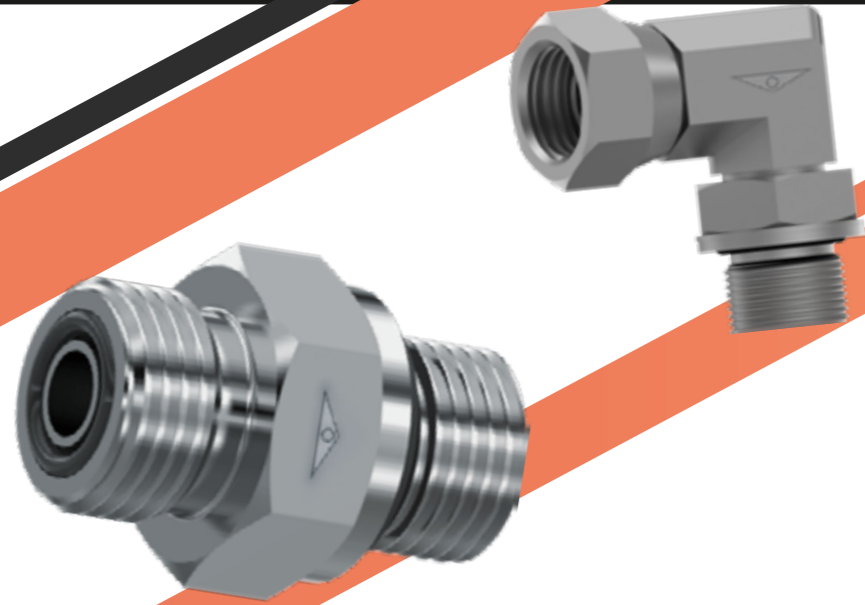

**ADAPTADORES VINCKE**  
**VINCKE ADAPTERS**  
**ADAPTEURS VINCKE**

**01** **ADAPTADORES BSPP**  
 BSPP ADAPTER  
 ADAPTEURS BSPP  
 PÁGINA 173

**02** **ADAPTADORES ORFS**  
 ORFS ADAPTERS  
 ADAPTEURS ORFS  
 PÁGINA 188

**03** **BRIDAS SAE**  
 SAE FLANGES  
 BRIDES SAE  
 PÁGINA 194



Disponemos de una amplia gama y rápida disponibilidad en adaptadores hidráulicos BSP, lo que nos permite responder de forma ágil a las necesidades del mercado industrial y de mantenimiento.

Los adaptadores BSP Vincke son ideales para aplicaciones de media y alta presión, cumpliendo con los estándares más exigentes del sector hidráulico.

At Vincke, we offer a wide range of BSP hydraulic adapters with fast availability, allowing us to respond quickly and efficiently to the demands of industrial and maintenance markets.

Vincke BSP adapters are ideal for medium and high-pressure hydraulic applications, meeting the industry's most stringent standards.

*Chez Vincke, nous proposons une large gamme d'adaptateurs hydrauliques BSP avec une disponibilité rapide, ce qui nous permet de répondre efficacement aux besoins des secteurs industriels et de la maintenance.*

*Les adaptateurs BSP Vincke sont parfaitement adaptés aux applications hydrauliques de moyenne et haute pression, selon les normes les plus strictes du marché.*

## ADAPTADORES BSPP

### BSPP ADAPTER

### ADAPTEURS BSPP

**ADAPTADORES BSPP**  
BSPP ADAPTER  
ADAPTEURS BSPP



**TUERCA BSPP (ALTA PRESIÓN)**  
BSPP NUT (HIGH PRESSURE)  
ÉCROU BSPP (HAUTE PRESSION)

Ref.		€
RAC06000002	1/8	0,81
RAC06000004	1/4	1,23
RAC06000006	3/8	1,39
RAC06000008	1/2	1,84
RAC06000012	3/4	2,77
RAC06000016	1"	5,31
RAC06000020	1" 1/4	13,04
RAC06000024	1" 1/2	14,34
RAC06000032	2"	21,52

**RACOR SOLDABLE**  
WELDING FITTING  
RACCORDS À SOUDER



**CONO BSPP SOLDABLE**  
BSPP WELDING MALE  
CÔNE BSPP À SOUDER

Ref.		€
RAC06001002	1/8	0,90
RAC06001004	1/4	1,02
RAC06001006	3/8	1,32
RAC06001008	1/2	1,70
RAC06001012	3/4	2,38
RAC06001016	1"	3,69
RAC06001020	1" 1/4	9,36
RAC06001024	1" 1/2	10,54
RAC06001032	2"	14,06



**MANGUITO SOLDABLE ROSCA INTERIOR**  
WELDING ADAPTER INNER THREAD  
MANCHON À SOUDER FILETAGE INTÉRIEUR

Ref.		€
RAC06002002	1/8	1,70
RAC06002004	1/4	1,92
RAC06002006	3/8	2,36
RAC06002008	1/2	3,86
RAC06002012	3/4	4,60
RAC06002016	1"	7,96
RAC06002020	1" 1/4	16,73
RAC06002024	1" 1/2	19,75
RAC06002032	2"	32,16



**EMPALME LISO SOLDABLE BSPP CONO 60°**  
60° BSPP WELDING CONE UNION  
UNION LISSE À SOUDER BSPP CÔNE 60°

Ref.		€
RAC060030002	1/8	1,97
RAC060030004	1/4	1,35
RAC060030006	3/8	1,50
RAC060030008	1/2	1,98
RAC060030012	3/4	3,07
RAC060030016	1"	5,79
RAC060030020	1" 1/4	14,69
RAC060030024	1" 1/2	17,44
RAC060030032	2"	24,67



**MACHO BSPP CONO 60° SOLDABLE CON PERNO**  
60° BSPP MALE WELDING CONE  
MÂLE BSPP CÔNE 60° À SOUDER AVEC BOULON

Ref.		€
RAC060040002	1/8	1,46
RAC060040004	1/4	1,51
RAC060040006	3/8	1,73
RAC060040008	1/2	2,33
RAC060040012	3/4	3,47
RAC060040016	1"	6,82
RAC060040020	1" 1/4	17,76
RAC060040024	1" 1/2	21,57
RAC060040032	2"	39,33



**MACHO BSPP CONO 60° SOLDABLE CON ENCASTE**  
60° BSPP MALE WELDING CONE  
MÂLE BSPP CÔNE 60° À SOUDER AVEC PRISE

Ref.		€
RAC060050002	1/8	1,97
RAC060050004	1/4	1,38
RAC060050006	3/8	1,83
RAC060050008	1/2	2,46
RAC060050012	3/4	3,90
RAC060050016	1"	8,67
RAC060050020	1" 1/4	23,88
RAC060050024	1" 1/2	22,55
RAC060050032	2"	42,28ss



**ESFÉRICO BSPP SOLDABLE**  
BSPP WELDING BANJO  
BANJO BSPP À SOUDER

Ref.		€
RAC060080002	1/8	6,76
RAC060080004	1/4	10,47
RAC060080006	3/8	8,75
RAC060080008	1/2	10,61
RAC060080012	3/4	22,54
RAC060080016	1"	31,56

**RACOR RECTO**  
STRAIGHT FITTING  
RACCORD DROIT



**MANGUITO HEXAGONAL ROSCA INTERIOR**  
HEXAGONAL INNER THREAD ADAPTER  
MANCHON HEXAGONAL FILETAGE INTÉRIEUR

Ref.		€
RAC060510004	1/4	1,75
RAC060510006	3/8	2,47
RAC060510008	1/2	2,96
RAC060510012	3/4	4,81
RAC060510016	1"	6,89
RAC060510020	1" 1/4	22,52
RAC060510024	1" 1/2	29,06

**ESFÉRICO BSPP ROSCADO**  
BSPP THREADED BANJO  
BANJO BSPP TARAUDÉ



Ref.		€
RAC060090002	1/8	6,83
RAC060090004	1/4	3,88
RAC060090006	3/8	4,41
RAC060090008	1/2	6,17
RAC060090012	3/4	12,04
RAC060090016	1"	33,43

**TAPÓN REDUCTOR MACHO 60° HEMBRA FIJA BSPP**  
MALE REDUCER 60° PLUG BSPP STRAIGHT FEMALE  
BOUCHON RÉDUCTEUR MÂLE 60° FEMELLE FIXE BSPP



Ref.			€
RAC060160402	1/4	1/8	1,38
RAC060160602	3/8	1/8	2,18
RAC060160604	3/8	1/4	1,56
RAC060160804	1/2	1/4	2,27
RAC060160806	1/2	3/8	2,59
RAC060161206	3/4	3/8	3,10
RAC060161208	3/4	1/2	3,42
RAC060161606	1"	3/8	6,86
RAC060161608	1"	1/2	5,41
RAC060161612	1"	3/4	5,41
RAC060162012	1" 1/4	3/4	14,70
RAC060162016	1" 1/4	1"	16,07
RAC060162416	1" 1/2	1"	19,85
RAC060162420	1" 1/2	1" 1/4	19,79
RAC060163220	2"	1" 1/4	32,14
RAC060163224	2"	1" 1/2	31,88



**SUPLEMENTO MACHO-HEMBRA FIJA BSPP**  
MALE STRAIGHT FEMALE BSPP ADAPTER  
SUPPLÉMENT MÂLE-FEMELLE FIXE BSPP

Ref.			€
RAC060170202	1/8	1/8	2,11
RAC060170204	1/8	1/4	1,78
RAC060170206	1/8	3/8	2,43
RAC060170402	1/4	1/8	1,97
RAC060170404	1/4	1/4	1,72
RAC060170406	1/4	3/8	1,93
RAC060170408	1/4	1/2	3,31
RAC060170602	3/8	1/8	2,38
RAC060170604	3/8	1/4	1,98
RAC060170606	3/8	3/8	2,11
RAC060170608	3/8	1/2	2,78
RAC060170612	3/8	3/4	5,22
RAC060170804	1/2	1/4	3,12
RAC060170806	1/2	3/8	2,58
RAC060170808	1/2	1/2	2,84
RAC060170812	1/2	3/4	3,55
RAC060170816	1/2	1"	7,04
RAC060171206	3/4	3/8	6,58
RAC060171208	3/4	1/2	4,58
RAC060171212	3/4	3/4	4,30

Ref.			€
RAC060171216	3/4	1"	7,15
RAC060171220	3/4	1" 1/4	25,06
RAC060171608	1"	1/2	7,59
RAC060171612	1"	3/4	7,59
RAC060171616	1"	1"	6,67
RAC060171620	1"	1" 1/4	21,92
RAC060171624	1"	1" 1/2	29,94
RAC060172012	1" 1/4	3/4	27,79
RAC060172016	1" 1/4	1"	23,56
RAC060172020	1" 1/4	1" 1/4	21,90
RAC060172024	1" 1/4	1" 1/2	24,33
RAC060172032	1" 1/4	2"	39,37
RAC060172416	1" 1/2	1"	27,04
RAC060172420	1" 1/2	1" 1/4	29,54
RAC060172424	1" 1/2	1" 1/2	26,91
RAC060172432	1" 1/2	2"	56,15
RAC060173220	2"	1" 1/4	40,95
RAC060173224	2"	1" 1/2	41,32
RAC060173232	2"	2"	54,70

**UNIÓN MACHO-MACHO BSPP**  
BSPP MALE-MALE UNION  
UNION MÂLE-MÂLE BSPP



Ref.			€
RAC060180202	1/8	1/8	1,23
RAC060180204	1/8	1/4	1,25
RAC060180206	1/8	3/4	1,71
RAC060180404	1/4	1/4	1,07
RAC060180406	1/4	3/8	1,36
RAC060180408	1/4	1/2	2,11
RAC060180606	3/8	3/8	1,34
RAC060180608	3/8	1/2	1,95
RAC060180612	3/8	3/4	3,71
RAC060180808	1/2	1/2	1,95
RAC060180810	1/2	5/8	3,78
RAC060180812	1/2	3/4	3,08
RAC060180816	1/2	1"	5,96
RAC060181010	5/8	5/8	3,20

Ref.			€
RAC060181212	3/4	3/4	3,04
RAC060181216	3/4	1"	5,53
RAC060181220	3/4	1" 1/4	15,90
RAC060181224	3/4	1" 1/4	29,00
RAC060181616	1"	1"	5,39
RAC060181620	1"	1" 1/4	14,75
RAC060181624	1"	1" 1/2	19,81
RAC060182020	1" 1/4	1" 1/4	13,81
RAC060182024	1" 1/4	1" 1/2	18,89
RAC060182032	1" 1/4	2"	24,50
RAC060182424	1" 1/2	1" 1/2	20,96
RAC060182432	1" 1/2	2"	28,29
RAC060183232	2"	2"	30,67

**UNIÓN MACHO-MACHO BSPP-NPTF**

 BSPP-NPTF MALE-MALE UNION  
 UNION MÂLE-MÂLE BSPP-NPTF

Ref.	1/8"	1/4"	€
RAC060190202	1/8	1/8	2,21
RAC060190204	1/8	1/4	2,73
RAC060190404	1/4	1/4	1,73
RAC060190406	1/4	3/8	3,12
RAC060190604	3/8	1/4	2,15
RAC060190606	3/8	3/8	3,00
RAC060190806	1/2	3/8	2,81
RAC060190808	1/2	1/2	3,43
RAC060190812	1/2	3/4	4,03
RAC060191208	3/4	1/2	7,25

Ref.	3/4"	1"	€
RAC060191212	3/4	3/4	4,33
RAC060191216	3/4	1"	11,02
RAC060191612	1"	3/4	11,02
RAC060191616	1"	1"	7,40
RAC060191620	1"	1" 1/4	24,25
RAC060192016	1" 1/4	1"	24,96
RAC060192020	1" 1/4	1" 1/4	29,11
RAC060192424	1" 1/2	1" 1/2	35,32
RAC060193232	2"	2"	31,33

**MACHO-HEMBRA GIRATORIA 60° BSPP**

 BSPP MALE - 60° SWIVEL FEMALE  
 MÂLE-FEMELLE TOURNANTE 60° BSPP

Ref.	1/8"	1/4"	€
RAC060200202	1/8	1/8	3,48
RAC060200204	1/8	1/4	4,52
RAC060200404	1/4	1/4	2,54
RAC060200406	1/4	3/8	3,28
RAC060200604	3/8	1/4	3,94
RAC060200606	3/8	3/8	3,20
RAC060200608	3/8	1/2	4,24
RAC060200806	1/2	3/8	6,48
RAC060200808	1/2	1/2	4,04
RAC060200812	1/2	3/4	7,30

Ref.	3/4"	1"	€
RAC060201208	3/4	1/2	9,48
RAC060201212	3/4	3/4	5,76
RAC060201216	3/4	1"	9,70
RAC060201616	1"	1"	12,23
RAC060201620	1"	1" 1/4	23,61
RAC060202016	1" 1/4	1"	28,45
RAC060202020	1" 1/4	1" 1/4	28,76
RAC060202024	1" 1/4	1" 1/2	43,26
RAC060202424	1" 1/2	1" 1/2	35,35

**MACHO NPTF - HEMBRA BSPP GIRATORIA 60°**

 NPTF MALE - 60° BSPP SWIVEL FEMALE  
 MÂLE NPTF - FEMELLE TOURNANTE BSPP 60°

Ref.	1/8"	1/4"	€
RAC060210202	1/8	1/8	3,90
RAC060210404	1/4	1/4	5,80
RAC060210606	3/8	3/8	7,13
RAC060210808	1/2	1/2	10,26

Ref.	3/4"	1"	€
RAC060211212	3/4	3/4	12,49
RAC060211616	1"	1"	20,74
RAC060212020	1" 1/4	1" 1/4	28,39
RAC060212424	1" 1/2	1" 1/2	42,55

**HEMBRA GIRATORIA BSPP 60° - HEMBRA BSPP GIRATORIA 60°**

 60° BSPP SWIVEL FEMALE - 60° BSPP SWIVEL FEMALE  
 FEMELLE TOURNANTE BSPP FEMELLE TOURNANTE BSPP 60°

Ref.	1/8"	1/4"	€
RAC060220202	1/8	1/8	7,13
RAC060220404	1/4	1/4	4,14
RAC060220606	3/8	3/8	4,99
RAC060220808	1/2	1/2	6,39

Ref.	3/4"	1"	€
RAC060221212	3/4	3/4	9,45
RAC060221616	1"	1"	17,50
RAC060222020	1" 1/4	1" 1/4	31,34
RAC060222424	1" 1/2	1" 1/2	40,26

**RACOR GIRATORIO RECTO**

 STRAIGHT SWIVEL  
 RACCORD TOURNANT DROIT

Ref.	1/4"	€
STU2604	1/4	28,67
STU2606	3/8	31,42
STU2608	1/2	36,62
STU2612	3/4	56,16
STU2616	1"	81,69
STU2620	1" 1/4	124,36
STU2624	1" 1/2	189,13
STU2632	2"	283,37

**PASATABIQUES CON TUERCA BSPP**

 BULKHEAD WITH NUT BSPP  
 PASSE CLOISON AVEC ÉCROU BSPP

Ref.	1/8"	€
RAC060230002	1/8	3,85
RAC060230004	1/4	3,18
RAC060230006	3/8	3,83
RAC060230008	1/2	4,95
RAC060230012	3/4	7,66
RAC060230016	1"	15,58
RAC060230020	1" 1/4	33,06
RAC060230024	1" 1/2	66,85
RAC060230032	2"	139,36

**CONTRATUERCA (PASATABIQUES) BSPP**

 COUNTER NUT (BULKHEAD) BSPP  
 CONTRE-ÉCROU (PASSE CLOISONS) BSPP

Ref.	1/8"	€
RAC060240002	1/8	0,85
RAC060240004	1/4	0,84
RAC060240006	3/8	0,90
RAC060240008	1/2	1,13
RAC060240012	3/4	1,88
RAC060240016	1"	3,50
RAC060240020	1" 1/4	7,23
RAC060240024	1" 1/2	11,80
RAC060240032	2"	17,71

**TORNILLO ORIENTABLE SIMPLE BSPP**

 BSPP SINGLE ADJUSTABLE BOLT  
 VIS ORIENTABLE SIMPLE BSPP

Ref.	1/8"	€
RAC060250002	1/8	1,75
RAC060250004	1/4	1,68
RAC060250006	3/8	1,92
RAC060250008	1/2	3,01
RAC060250012	3/4	4,39
RAC060250016	1"	10,09
RAC060250020	1" 1/4	22,40



**TORNILLO ORIENTABLE DOBLE BSPP**

DOUBLE ADJUSTABLE BOLT  
VIS ORIENTABLE DOUBLE BSPP

Ref.		€
RAC060260002	1/8	5,85
RAC060260004	1/4	2,69
RAC060260006	3/8	4,39
RAC060260008	1/2	6,89
RAC060260012	3/4	12,01
RAC060260016	1"	18,79

**TORNILLO ORIENTABLE SIMPLE PROLONGADO BSPP**

BSPP SINGLE ADJUSTABLE BOLT BSPP (LONGER)  
VIS ORIENTABLE SIMPLE PROLONGÉE BSPP



Ref.			€
RAC060270202	1/8	1/8	3,77
RAC060270204	1/8	1/4	3,21
RAC060270206	1/8	3/8	3,78
RAC060270404	1/4	1/4	3,12
RAC060270406	1/4	3/8	6,91
RAC060270408	1/4	1/2	5,35
RAC060270606	3/8	3/8	4,36
RAC060270608	3/8	1/2	5,35
RAC060270612	3/8	3/4	9,02
RAC060270808	1/2	1/2	6,16
RAC060270812	1/2	3/4	6,75
RAC060270816	1/2	1"	15,18
RAC060271212	3/8	3/4	7,36
RAC060271216	3/4	1"	15,18
RAC060271220	3/4	1" 1/4	24,48
RAC060271616	1"	1"	15,85
RAC060271620	1"	1" 1/4	25,65
RAC060272020	1" 1/4	1" 1/4	25,65



**TAPÓN HEMBRA BSPP**

BSPP FEMALE PLUG  
BOUCHON FEMELLE BSPP

Ref.		€
RAC060120002	1/8	1,59
RAC060120004	1/4	1,32
RAC060120006	3/8	1,67
RAC060120008	1/2	2,14
RAC060120012	3/4	5,69
RAC060120016	1"	4,99
RAC060120020	1" 1/4	15,88



**TAPÓN HEMBRA BSPP CIERRE CONO 60°**

BSPP FEMALE PLUG 60° CONE  
BOUCHON FEMELLE BSPP FERMETURE CÔNE 60°

Ref.		€
RAC060530004	1/4	1,50
RAC060530006	3/8	1,81
RAC060530008	1/2	2,09
RAC060530012	3/4	4,63
RAC060530016	1"	7,96
RAC060530020	1" 1/4	21,21



**TAPÓN MACHO BSPP CIERRE CONO 60°**

BSPP MALE PLUG 60° CONE  
BOUCHON MÂLE BSPP FERMETURE CÔNE 60°

Ref.		€
RAC060520002	1/8	1,14
RAC060520004	1/4	1,22
RAC060520006	3/8	1,35
RAC060520008	1/2	1,67
RAC060520012	3/4	2,60
RAC060520016	1"	4,69
RAC060520020	1" 1/4	13,21
RAC060520024	1" 1/2	20,09
RAC060520032	2"	27,68



**TAPÓN MACHO BSPP ALLEN**

BSPP MALE PLUG ALLEN  
BOUCHON MÂLE BSPP ALLEN

Ref.		€
RAC060140002	1/8	1,63
RAC060140004	1/4	2,04
RAC060140006	3/8	1,88
RAC060140008	1/2	3,01
RAC060140012	3/4	5,03
RAC060140016	1"	8,09

**CURVA ACCESORIAL**  
ACCESSORIAL ELBOWS  
ADAPTEUR COURBE 90°

**CODOS FORJADOS**  
FORGING ELBOWS  
COUDES FORGÉS



**CURVA ACCESORIAL 90° MACHO FIJO HEMBRA GIRATORIA BSPP**  
CURVE 90° STUD MALE-BSPP SWIVEL FEMALE  
COURBE 90° MÂLE FIXE FEMELLE TOURNANTE BSPP

Ref.		€
RAC060280404	1/4	6,11
RAC060280606	3/8	6,27
RAC060280808	1/2	8,58
RAC060281212	3/4	14,48
RAC060281616	1"	21,05



**CURVA ACCESORIAL 45° MACHO FIJO HEMBRA GIRATORIA BSPP**  
CURVE 45° STUD MALE- BSPP SWIVEL FEMALE  
ADAPTEUR COURBE 45° MÂLE FIXE FEMELLE TOURNANTE BSPP

Ref.		€
RAC060290202	1/8	8,01
RAC060290404	1/4	8,80
RAC060290606	3/8	7,41
RAC060290808	1/2	10,40
RAC060291212	3/4	22,25
RAC060291616	1"	23,07
RAC060292020	1" 1/4	57,38
RAC060292424	1" 1/2	79,40

**CURVA ACCESORIAL 90° MACHO FIJO MACHO FIJO BSPP**  
CURVE 90° STUD MALE- BSPP STUD MALE STUD MALE  
ADAPTEUR COURBE 90° MÂLE FIXE MÂLE FIXE BSPP



Ref.		€
RAC060300202	1/8	6,41
RAC060300404	1/4	6,40
RAC060300606	3/8	7,42
RAC060300808	1/2	10,40
RAC060301212	3/4	16,31
RAC060301616	1"	24,86
RAC060302020	1" 1/4	47,38
RAC060302424	1" 1/2	79,40



**CURVA ACCESORIAL 90° HEMBRA GIRATORIA HEMBRA GIRATORIA BSPP**  
CURVE 90° SWIVEL FEMALE - BSPP SWIVEL FEMALE SWIVEL FEMALE  
ADAPTEUR COURBE 90° FEMELLE TOURNANTE FEMELLE TOURNANTE BSPP

Ref.		€
RAC060320202	1/8	7,26
RAC060320404	1/4	6,58
RAC060320606	3/8	7,12
RAC060320808	1/2	11,83
RAC060321212	3/4	15,69
RAC060321616	1"	23,20



**CODO 90° MACHO FIJO MACHO FIJO BSPP (CIERRE POR 60° O POR JUNTA METALGOMA)**  
90° ELBOW BSPP STUD MALE-STUD MALE (TIGHTNESS BY 60° CONE OR CAPTIVE SEAL)  
COUDE 90° MÂLE FIXE MÂLE FIXE BSPP (FERMETURE CÔNE OU BAGUE BS)

Ref.			€
RAC060340202	1/8	1/8	7,47
RAC060340404	1/4	1/4	5,10
RAC060340606	3/8	3/8	5,90
RAC060340608	3/8	1/2	9,95
RAC060340808	1/2	1/2	8,59
RAC060341212	3/4	3/4	12,65
RAC060341616	1"	1"	22,60
RAC060341620	1"	1" 1/4	70,54
RAC060342020	1" 1/4	1" 1/4	60,11
RAC060342024	1" 1/4	1" 1/2	67,85
RAC060342424	1" 1/2	1" 1/2	105,99



**CODO 90° MACHO FIJO MACHO FIJO BSPP**  
90° ELBOW BSPP STUD MALE-STUD MALE  
COUDE 90° MÂLE FIXE MÂLE FIXE BSPP

Ref.		€
RAC060430404	1/4	4,49
RAC060430808	1/2	7,71
RAC060431616	1"	22,11



**CODO 90° MACHO FIJO HEMBRA GIRATORIA BSPP CON JUNTA (CIERRE POR 60° O POR JUNTA)**  
90° ELBOW STUD MALE-BSPP SWIVEL FEMALE WITH O RING (TIGHTNESS BY 60° CONE OR O'RING)  
COUDE 90° MÂLE FIXE FEMELLE TOURNANTE BSPP AVEC JOINT (FERMETURE CÔNE OU JOINT)

Ref.			€
RAC060350202	1/8	1/8	8,68
RAC060350404	1/4	1/4	5,74
RAC060350606	3/8	3/8	7,90
RAC060350808	1/2	1/2	9,11
RAC060351212	3/4	3/4	14,07
RAC060351616	1"	1"	20,00
RAC060352020	1" 1/4	1" 1/4	41,39
RAC060352424	1" 1/2	1" 1/2	74,34
RAC060353232	2"	2"	537,18

**CODO 90° HEMBRA GIRATORIA HEMBRA GIRATORIA BSPP**

90° ELBOW SWIVEL FEMALE SWIVEL FEMALE  
COUDE 90° FEMELLE TOURNANTE FEMELLE TOURNANTE BSPP



Ref.			€
RAC060570404		1/4	12,07
RAC060570606		3/8	14,24
RAC060570808		1/2	19,74
RAC060571212		3/4	27,60

**CODO 90° HEMBRA FIJA HEMBRA FIJA BSPP**

90° ELBOW STUD FEMALE-BSPP STUD FEMALE  
COUDE 90° FEMELLE FIXE FEMELLE FIXE BSPP



Ref.			€
RAC060360404		1/4	8,48
RAC060360606		3/8	9,95
RAC060360808		1/2	13,88
RAC060361212		3/4	22,47
RAC060361616		1"	30,45
RAC060362020		1" 1/4	93,74

**CODO 90° MACHO ORIENTABLE MACHO FIJO BSPP**

90° ELBOW BSPP ADJUST. MALE STUD MALE  
COUDE 90° MÂLE ORIENTABLE MÂLE FIXE BSPP



Ref.			€
RAC060370404		1/4	6,65
RAC060370606		3/8	8,19
RAC060370808		1/2	10,61
RAC060371212		3/4	15,02
RAC060371616		1"	29,56
RAC060372020		1" 1/4	36,90

**CODO 90° MACHO ORIENTABLE HEMBRA GIRATORIA BSPP**

90° ELBOW BSPP ADJUST. MALE SWIVEL FEMALE BSPP  
COUDE 90° MÂLE ORIENTABLE FEMELLE TOURNANTE BSPP



Ref.			€
RAC060580404		1/4	9,41
RAC060580606		3/8	11,10
RAC060580808		1/2	15,56
RAC060581212		3/4	19,87
RAC060581616		1"	35,50

**ADAPTADOR BSPP HID. C/45 M - HG**

90° ELBOW STUD MALE-BSPP SWIVEL FEMALE  
ADAPTEUR BSPP HYD. C/45 M - HG



Ref.			€
RAC060540404		1/4	17,73
RAC060540606		3/8	21,35
RAC060540808		1/2	23,07
RAC060541212		3/4	32,10
RAC060541616		1"	63,03

**CODO 45° MACHO ORIENTABLE MACHO FIJO BSPP**

45° ADJUSTABLE MALE ELBOW -BSPP STUD MALE  
COUDE 45° MÂLE ORIENTABLE MÂLE FIXE BSPP



Ref.			€
RAC060550404		1/4	18,16
RAC060550606		3/8	22,55
RAC060550808		1/2	27,34
RAC060551212		3/4	40,58
RAC060551616		1"	76,96

**RACOR GIRATORIO 90°**

90° ELBOW SWIVEL  
RACCORD TOURNANT 90°



Ref.			€
STU2704		1/4	31,61
STU2706		3/8	35,98
STU2708		1/2	42,97
STU2712		3/4	74,41
STU2716		1"	103,35
STU2720		1" 1/4	189,61
STU2724		1" 1/2	265,45
STU2732		2"	356,44

**T FORJADAS**  
FORGING T  
T EN FORGE

**T CUADRADA MACHO FIJO- MACHO FIJO- MACHO FIJO BSPP (CIERRE POR 60° O POR JUNTA)**

T SQUARED BSPP STUD MALE STUD MALE STUD MALE (TIGHTNESS BY 60° CONE OR O'RING)  
T CARRÉ MÂLE FIX MÂLE FIXE MÂLE FIXE BSPP (FERMETURE CÔNE OU JOINT)



Ref.		€
RAC060380202	1/8	8,69
RAC060380404	1/4	6,07
RAC060380606	3/8	7,82
RAC060380808	1/2	8,95
RAC060381212	3/4	14,70
RAC060381616	1"	30,39
RAC060382020	1" 1/4	139,42
RAC060382424	1" 1/2	215,53

**T CUADRADA MACHO FIJO MACHO FIJO HEMBRA GIRATORIA BSPP CON JUNTA**

T BSPP SQUARED STUD MALE STUD MALE SWIVEL FEMALE WITH O'RING  
T CARRÉ MÂLE FIXE MÂLE FIXE FEMELLE TOURNANTE BSPP AVEC JOINT



Ref.		€
RAC060390404	1/4	8,11
RAC060390606	3/8	9,56
RAC060390808	1/2	14,56
RAC060391212	3/4	21,89
RAC060391616	1"	33,52
RAC060392020	1" 1/4	142,07

**T CUADRADA MACHO FIJO HEMBRA GIRATORIA MACHO FIJO BSPP**

T BSPP SQUARED STUD MALE SWIVEL FEMALE-STUD MALE  
T CARRÉ MÂLE FIXE FEMELLE TOURNANTE MÂLE FIXE BSPP



Ref.		€
RAC060400202	1/8	8,74
RAC060400404	1/4	7,40
RAC060400606	3/8	9,51
RAC060400808	1/2	13,84
RAC060401212	3/4	19,60
RAC060401616	1"	33,05
RAC060402020	1" 1/4	172,73
RAC060402424	1" 1/2	2 52,44

**T HEMBRA FIJA HEMBRA FIJA HEMBRA FIJA BSPP**

T BSPP STUD FEMALE-STUD FEMALE STUD FEMALE  
T FEMELLE FIXE FEMELLE FIXE FEMELLE FIXE BSPP



Ref.		€
RAC060410404	1/4	8,39
RAC060410606	3/8	10,45
RAC060410808	1/2	15,37
RAC060411212	3/4	27,49
RAC060411616	1"	54,33
RAC060412020	1" 1/4	100,64
RAC060412424	1" 1/2	177,09

**T MACHO FIJO MACHO ORIENT. MACHO FIJO BSPP**

T BSPP STUD MALE ADJUST MALE STUD MALE  
T MÂLE FIXE MÂLE ORIENTABLE MÂLE FIXE BSPP



Ref.		€
RAC060590404	1/4	7,42
RAC060590606	3/8	12,36
RAC060590808	1/2	18,12
RAC060591212	3/4	29,37

**T MACHO FIJO MACHO FIJO MACHO ORIENTABLE BSPP**

T BSPP STUD MALE-STUD MALE-MALE ADJUSTABLE  
T MÂLE FIXE MÂLE FIXE MÂLE ORIENTABLE BSPP



Ref.		€
RAC060600404	1/4	7,42
RAC060600606	3/8	12,36
RAC060600808	1/2	18,12
RAC060601212	3/4	29,37

**CRUZ MACHO FIJO BSPP**

CROSS MALE STUD BSPP  
CROIX MÂLE FIXE BSPP



Ref.		€
RAC060420404	1/4	8,79
RAC060420606	3/8	10,27
RAC060420808	1/2	16,37
RAC060421212	3/4	44,00

**ADAPTADORES ORFS**  
ORFS ADAPTERS  
ADAPTATEURS ORFS



**ASIENTO SOLDABLE ORFS**

FLAT SEAT ORFS  
FOND PLAT À SOUDER ORFS

Ref.		€
RAC071000604	9/16-18	4,04
RAC071000806	11/16-16	4,36
RAC071001006	11/16-16	2,52
RAC071001208	13/16-16	4,48
RAC071001410	1"-14	5,04
RAC071001510	1"-14	5,81
RAC071002012	1" 3/16-12	5,64
RAC071002516	1" 7/16-12	13,95
RAC071003220	1" 11/16-12	24,69
RAC071003824	2"-12	27,89

**TUERCA ORFS**

ORFS NUT  
ÉCROU ORFS



Ref.		€
RAC071010004	9/16-18	3,31
RAC071010006	11/16-16	3,70
RAC071010008	13/16-16	4,20
RAC071010010	1"-14	5,18
RAC071010012	1" 3/16-12	4,17
RAC071010016	1" 7/16-12	10,92
RAC071010020	1" 11/16-12	19,95
RAC071010024	2"-12	22,16

**TAPÓN HEMBRA ORFS**

ORFS FEMALE PLUG  
BOUCHON FEMELLE ORFS



Ref.		€
RAC071020004	9/16-18	2,35
RAC071020006	11/16-16	4,25
RAC071020008	13/16-16	5,03
RAC071020010	1"-14	4,12
RAC071020012	1" 3/16-12	4,73
RAC071020016	1" 7/16-12	11,18
RAC071020020	1" 11/16-12	14,01
RAC071020024	2"-12	39,45



**TAPÓN MACHO ORFS**

ORFS MALE PLUG  
BOUCHON MÂLE ORFS

Ref.		€
RAC071030004	9/16-18	2,35
RAC071030006	11/16-16	4,25
RAC071030008	13/16-16	5,03
RAC071030010	1"-14	4,12
RAC071030012	1" 3/16-12	4,73
RAC071030016	1" 7/16-12	11,18
RAC071030020	1" 11/16-12	14,01
RAC071030024	2"-12	39,45



**SOLDABLE MACHO ORFS**

ORFS WELDING MALE  
MÂLE À SOUDER ORFS

Ref.		€
RAC071040004	9/16-18	14,18
RAC071040006	11/16-16	15,99
RAC071040008	13/16-16	9,05
RAC071040010	1"-14	14,83
RAC071040012	1" 3/16-12	13,01
RAC071040016	1" 7/16-12	19,99
RAC071040020	1" 11/16-12	20,18
RAC071040024	2"-12	27,90



**UNIÓN MACHO MACHO ORFS**

ORFS MALE MALE UNION  
UNION MÂLE MÂLE ORFS

Ref.		€
RAC071050004	9/16-18	2,37
RAC071050006	11/16-16	6,62
RAC071050008	13/16-16	4,64
RAC071050010	1"-14	6,38
RAC071050012	1" 3/16-12	9,86
RAC071050016	1" 7/16-12	28,50
RAC071050020	1" 11/16-12	18,38
RAC071050024	2"-12	81,83



**UNIÓN MACHO MACHO ORFS / BSPP**

ORFS / BSPP MALE MALE UNION  
UNION MÂLE MÂLE ORFS / BSPP

Ref.			€
RAC071060402	9/16-18	1/8	2,62
RAC071060404	9/16-18	1/4	2,66
RAC071060606	11/16-16	3/8	3,80
RAC071060806	13/16-16	3/8	9,79
RAC071060808	13/16-16	1/2	12,41
RAC071061008	1"-14	1/2	7,77
RAC071061212	1" 3/16-12	3/4	9,54
RAC071061612	1" 7/16-12	3/4	21,25
RAC071061616	1" 7/16-12	1"	10,66
RAC071062020	1" 11/16-12	1" 1/4	49,90
RAC071062424	2"-12	1" 1/2	67,03

**UNIÓN MACHO MACHO ORFS / NPTF**

ORFS / NPTF MALE MALE UNION  
UNION MÂLE MÂLE ORFS / NPTF



Ref.	Ø	Ø	€
RAC071070402	9/16-18	1/8	4,65
RAC071070404	9/16-18	1/4	10,16
RAC071070604	11/16-16	1/4	10,15
RAC071070606	11/16-16	3/8	13,21
RAC071070806	13/16-16	3/8	22,15
RAC071070808	13/16-16	1/2	17,16
RAC071071008	1"-14	1/2	20,07
RAC071071212	1" 3/16-12	3/4	51,37
RAC071071616	1" 7/16-12	1"	54,24

**UNIÓN MACHO MACHO ORFS / SAE-UNF**

ORFS / SAE-UNF MALE MALE UNION  
UNION MÂLE MÂLE ORFS / SAE-UNF



Ref.	Ø	Ø	€
RAC071080404	9/16	7/16	2,47
RAC071080606	11/16	9/16	3,61
RAC071080808	13/16	3/4	8,74
RAC071081010	1"	7/8	3,94
RAC071081212	1" 3/16	1" 1/16	8,09
RAC071081616	1" 7/16	1" 5/16	21,20

**UNIÓN HEMBRA GIRATORIA ORFS MACHO BSPP**

BSPP MALE -60° SWIVEL FEMALE ORFS  
UNION FEMELLE TOURNANTE ORFS MÂLE BSPP



Ref.	Ø	Ø	€
RAC071200404	9/16	1/4	4,39
RAC071200604	11/16	1/4	4,76
RAC071200606	11/16	3/8	4,84
RAC071200608	11/16	1/2	6,91
RAC071200806	13/16	3/8	6,91
RAC071200808	13/16	1/2	6,91
RAC071201008	1"	1/2	15,87
RAC071201012	1"	3/4	25,75
RAC071201212	1" 3/16	3/4	28,48
RAC071201612	1" 7/16	3/4	23,16
RAC071201616	1" 7/16	1"	27,78

**UNIÓN MACHO HEMBRA GIRATORIA ORFS**

MALE SWIVEL FEMALE ORFS  
UNION MÂLE FEMELLE TOURNANTE ORFS



Ref.	Ø	€
RAC071210404	9/16	4,21
RAC071210606	11/16	4,70
RAC071210808	13/16	4,88
RAC071211010	1"	7,60
RAC071211212	1" 3/16	8,32

**PASAMUROS ORFS**

ORFS BULKHEAD  
PASSE CLOISONS ORFS



Ref.	Ø	€
RAC071090004	9/16	6,40
RAC071090006	11/16	8,13
RAC071090008	13/16	20,57
RAC071090010	1"	21,07
RAC071090012	1" 3/16	21,82
RAC071090016	1" 7/16	42,45

**CODO PASATABIQUE 90° MACHO MACHO ORFS**

90° BULKHEAD ELBOW ORFS MALE MALE  
COUDE PASSE CLOISON 90° MÂLE MÂLE ORFS



Ref.	Ø	€
RAC071120004	9/16	21,19
RAC071120006	11/16	11,69
RAC071120008	13/16	17,66
RAC071120010	1"	19,71
RAC071120012	1" 3/16	24,37
RAC071120016	1" 7/16	42,61

**CONTRATUERCA ORFS**

ORFS COUNTER NUT  
CONTRE-ÉCROU ORFS



Ref.	Ø	€
RAC071240006	11/16	2,28
RAC071240008	13/16	1,76
RAC071240012	1" 3/16	10,64

**CODO 90° MACHO MACHO ORFS**

90° ORFS MALE MALE ELBOW  
COUDE 90° MÂLE MÂLE ORFS



Ref.	Ø	Ø	€
RAC071100004	9/16	9/16	5,23
RAC071100006	11/16	11/16	5,51
RAC071100008	13/16	13/16	12,47
RAC071100010	1"	1"	12,37
RAC071100012	1" 3/16	1" 3/16	10,60
RAC071100016	1" 7/16	1" 7/16	41,76

**CODO 90° MACHO HEMBRA ORFS**

90° ORFS MALE FEMALE ELBOW  
COUDE 90° MÂLE FEMELLE ORFS



Ref.	Ø	Ø	€
RAC071110004	9/16	9/16	8,09
RAC071110006	11/16	11/16	10,88
RAC071110008	13/16	13/16	9,92
RAC071110010	1"	1"	16,10
RAC071110012	1" 3/16	1" 3/16	21,97
RAC071110016	1" 7/16	1" 7/16	55,73

**CODO 90° MACHO ORFS MACHO ORIENTABLE BSPP**

90° ORFS MALE ELBOW-SAE UNF ADJUSTABLE MALE  
COUDE 90° MÂLE ORFS MÂLE ORIENTABLE BSPP



Ref.	Ø	Ø	€
RAC071130402	9/16	1/8	10,41
RAC071130404	9/16	1/4	7,37
RAC071130606	11/16	3/8	12,67
RAC071130808	13/16	1/2	13,87
RAC071131006	1"	3/8	10,10
RAC071131008	1"	1/2	10,15
RAC071131212	1" 3/16	3/4	19,98
RAC071131616	1" 7/16	1"	37,43

**CODO 90° MACHO ORFS MACHO ORIENTABLE SAE UNF**

90° ORFS MALE ELBOW-BSPP ADJUSTABLE MALE  
COUDE 90° MÂLE ORFS MÂLE ORIENTABLE SAE UNF



Ref.	Ø	Ø	€
RAC071140404	9/16	7/16	21,76
RAC071140606	11/16	9/16	12,53
RAC071140808	13/16	3/4	21,74
RAC071141010	1"	7/8	23,48
RAC071141212	1" 3/16	1" 1/16	37,49
RAC071141616	1" 7/16	1" 5/16	34,74

**CODO 90° HEMBRA ORFS MACHO ORIENTABLE SAE UNF**

90° ORFS FEMALE ELBOW-SAE UNF ADJUSTABLE MALE  
COUDE 90° FEMELLE ORFS MÂLE ORIENTABLE SAE UNF



Ref.	Ø	Ø	€
RAC071220404	9/16	7/16	18,42
RAC071220606	11/16	9/16	18,09
RAC071220808	13/16	3/4	20,66
RAC071221010	1"	7/8	23,23
RAC071221212	1" 3/16	1" 1/16	26,18
RAC071221616	1" 7/16	1" 5/16	36,16

**T MACHO FIJO MACHO FIJO MACHO FIJO ORFS**

T ORFS STUD MALE-STUD MALE-STUD MALE  
T MÂLE FIXE MÂLE FIXE MÂLE FIXE ORFS



Ref.	Ø	Ø	€
RAC071150404	9/16	9/16	23,29
RAC071150606	11/16	11/16	24,32
RAC071150808	13/16	13/16	26,39
RAC071151010	1"	1"	30,96
RAC071151212	1" 3/16	1" 3/16	46,42
RAC071151616	1" 7/16	1" 7/16	73,72

**T MACHO FIJO HEMBRA GIRATORIA MACHO FIJO ORFS**

T ORFS STUD MALE-SWIVEL FEMALE-STUD MALE  
T MÂLE FIXE FEMELLE TOURNANTE MÂLE FIXE ORFS



Ref.	Ø	Ø	€
RAC071160404	9/16	9/16	10,13
RAC071160606	11/16	11/16	21,10
RAC071160808	13/16	13/16	36,23
RAC071161010	1"	1"	35,97
RAC071161212	1" 3/16	1" 3/16	22,10
RAC071161616	1" 7/16	1" 7/16	104,43

**T MACHO FIJO MACHO FIJO HEMBRA GIRATORIA ORFS**

T ORFS STUD MALE-STUD MALE-SWIVEL FEMALE  
T MÂLE FIXE MÂLE FIXE FEMELLE TOURNANTE ORFS



Ref.	Ø	Ø	€
RAC071170404	9/16	9/16	30,71
RAC071170606	11/16	11/16	30,15
RAC071170808	13/16	13/16	27,60
RAC071171010	1"	1"	16,93
RAC071171212	1" 3/16	1" 3/16	22,45
RAC071171616	1" 7/16	1" 7/16	24,28

**BRIDAS SAE 3000PSI**  
SAE FLANGES PSI 3000  
BRIDES SAE 3000 PSI

**SEMIBRIDA PARTIDA SAE 3000 (CONJUNTO)**

SAE 3000 SPLIT FLANGE (KIT)  
BRIDE EN 2 PARTIES SAE 3000 (KIT)



Ref.		€
RACSS3000108	1/2	11,29
RACSS3000112	3/4	12,44
RACSS3000116	1"	13,54
RACSS3000120	1" 1/4	17,77
RACSS3000124	1" 1/2	21,15
RACSS3000132	2"	29,36
RACSS3000140	2" 1/2	47,68
RACSS3000150	3"	72,88

**BRIDA ENTERA SAE 3000**

SAE 3000 ENTIRE FLANGE  
BRIDE ENTIERE SAE 3000



Ref.		€
RACSE3000008	1/2	10,43
RACSE3000012	3/4	11,49
RACSE3000016	1"	12,56
RACSE3000020	1" 1/4	16,46
RACSE3000024	1" 1/2	32,16
RACSE3000032	2"	42,88
RACSE3000040	2" 1/2	44,17
RACSE3000050	3"	70,06

**CONO SOLDAR BRIDA SAE 3000**

SAE 3000 FLANGE WELDING CONE  
CÔNE À SOUDER BRIDE SAE 3000



Ref.		€
RACCS3000108	1/2	20,51
RACCS3000112	3/4	25,00
RACCS3000116	1"	27,33
RACCS3000120	1" 1/4	38,21
RACCS3000124	1" 1/2	42,48
RACCS3000132	2"	66,65
RACCS3000140	2" 1/2	77,10
RACCS3000150	3"	110,36

**CONO SOLDAR CONTRABRIDA SAE 3000**

SAE 3000 WELDING COUNTER FLANGE  
CÔNE À SOUDER CONTRE-BRIDE SAE 3000



Ref.		€
RACCS3000008	1/2	19,44
RACCS3000012	3/4	25,00
RACCS3000016	1"	27,33
RACCS3000020	1" 1/4	38,21
RACCS3000024	1" 1/2	42,48
RACCS3000032	2"	52,33
RACCS3000040	2" 1/2	79,92
RACCS3000050	3"	110,36

**BRIDA ROSCADA BSPP SAE 3000 PARA JUNTA**

SAE 3000 BSPP THREADED FLANGE FOR O-RING  
BRIDE TARAUDÉE BSPP SAE 3000 POUR JOINT



Ref.			€
RACMS3000108	1/2	1/2	45,41
RACMS3000112	3/4	3/4	32,42
RACMS3000116	1"	1"	39,20
RACMS3000120	1" 1/4	1" 1/4	47,79
RACMS3000124	1" 1/2	1" 1/2	59,60
RACMS3000132	2"	2"	73,18
RACMS3000140	2" 1/2	2" 1/2	89,39
RACMS3000150	3"	3"	106,64

**CONTRABRIDA ROSCADA BSPP SAE 3000 SIN JUNTA**

BSPP SAE 3000 COUNTER FLANGE WITHOUT O-RING  
CONTRE-BRIDE TARAUDÉE BSPP SAE 3000 SANS JOINT



Ref.			€
RACMS3000008	1/2	1/2	32,41
RACMS3000012	3/4	3/4	35,06
RACMS3000016	1"	1"	40,80
RACMS3000020	1" 1/4	1" 1/4	49,66
RACMS3000024	1" 1/2	1" 1/2	61,91
RACMS3000032	2"	2"	75,81
RACMS3000040	2" 1/2	2" 1/2	92,82
RACMS3000050	3"	3"	109,81

**BRIDA SOLDAR SAE 3000 PARA JUNTA**

SAE 3000 WELDING FLANGE FOR O-RING  
BRIDE À SOUDER SAE 3000 POUR JOINT



Ref.			€
RACMS3100108	1/2	1/2	28,13
RACMS3100112	3/4	3/4	44,03
RACMS3100116	1"	1"	36,22
RACMS3100120	1" 1/4	1" 1/4	43,11
RACMS3100124	1" 1/2	1" 1/2	55,25
RACMS3100132	2"	2"	67,78
RACMS3100140	2" 1/2	2" 1/2	82,61
RACMS3100150	3"	3"	99,90

**CONTRABRIDA SOLDAR SAE 3000 SIN JUNTA**

SAE 3000 WELDING COUNTER FLANGE WITHOUT O-RING  
CONTRE-BRIDE À SOUDER SAE 3000 SANS JOINT



Ref.			€
RACMS3100008	1/2	1/2	28,13
RACMS3100012	3/4	3/4	44,03
RACMS3100016	1"	1"	36,22
RACMS3100020	1" 1/4	1" 1/4	43,11
RACMS3100024	1" 1/2	1" 1/2	55,25
RACMS3100032	2"	2"	67,78
RACMS3100040	2" 1/2	2" 1/2	82,61
RACMS3100050	3"	3"	99,90

**TAPÓN BRIDA SAE 3000 PARA JUNTA**

SAE 3000 FLANGE PLUG FOR O-RING  
BOUCHON BRIDE SAE 3000 POUR JOINT



Ref.		€
RACMS3200108	1/2	24,31
RACMS3200112	3/4	24,31
RACMS3200116	1"	24,31
RACMS3200120	1" 1/4	29,75
RACMS3200124	1" 1/2	33,05
RACMS3200132	2"	37,00
RACMS3200140	2" 1/2	42,82
RACMS3200150	3"	66,21

**TAPÓN CONTRABRIDA SAE 3000 SIN JUNTA**

SAE 3000 COUNTER-FLANGE PLUG WITHOUT O-RING  
BOUCHON CONTRE-BRIDE SAE 3000 SANS JOINT



Ref.		€
RACMS3300108	1/2	27,77
RACMS3300112	3/4	27,77
RACMS3300116	1"	27,77
RACMS3300120	1" 1/4	32,90
RACMS3300124	1" 1/2	38,50
RACMS3300132	2"	42,18
RACMS3300140	2" 1/2	49,67
RACMS3300150	3"	76,63

**BRIDA SAE 3000 90° ROSCA BSPP PARA JUNTA**

90° BSPP SAE 3000 FLANGE FOR O-RING  
BRIDE SAE 3000 90° FILETAGE BSPP POUR JOINT



Ref.			€
RACMS3400108	1/2	1/2	71,78
RACMS3400112	3/4	3/4	79,05
RACMS3400116	1"	1"	88,97
RACMS3400120	1" 1/4	1" 1/4	105,18
RACMS3400124	1" 1/2	1" 1/2	133,73
RACMS3400132	2"	2"	162,93

**BRIDA SAE 3000 90° SOLDAR BSPP PARA JUNTA**

90° WELDING BSPP SAE 3000 FLANGE FOR O-RING  
BRIDE SAE 3000 90° À SOUDER BSPP POUR JOINT



Ref.			€
RACMS3500108	1/2	1/2	67,11
RACMS3500112	3/4	3/4	74,52
RACMS3500116	1"	1"	81,39
RACMS3500120	1" 1/4	1" 1/4	97,42
RACMS3500124	1" 1/2	1" 1/2	120,13
RACMS3500132	2"	2"	146,34

**SEMIBRIDA PARTIDA SAE 6000**

SAE 6000 SPLIT FLANGE  
BRIDE EN 2 PARTIES SAE 6000



Ref.		€
RACSS6000108	1/2	12,07
RACSS6000112	3/4	14,69
RACSS6000116	1"	18,89
RACSS6000120	1" 1/4	28,25
RACSS6000124	1" 1/2	50,17
RACSS6000132	2"	73,96

**BRIDA ENTERA SAE 6000**

ENTIRE FLANGE SAE 6000  
BRIDE ENTIÈRE SAE 6000



Ref.		€
RACSE6000008	1/2	11,17
RACSE6000012	3/4	13,59
RACSE6000016	1"	18,57
RACSE6000020	1" 1/4	26,15
RACSE6000024	1" 1/2	46,47
RACSE6000032	2"	68,51

**CONO SOLDAR BRIDA SAE 6000 PARA JUNTA**

WELDING CONE SAE 6000 FOR O-RING  
CÔNE À SOUDER BRIDE SAE 6000 POUR JOINT



Ref.		€
RACCS6000108	1/2	22,05
RACCS6000112	3/4	28,01
RACCS6000116	1"	31,24
RACCS6000120	1" 1/4	39,56
RACCS6000124	1" 1/2	46,43
RACCS6000132	2"	71,37

**CONO SOLDAR CONTRABRIDA SAE 6000**

SAE 6000 COUNTER FLANGE WELDING CONE  
CÔNE À SOUDER CONTRE-BRIDE SAE 6000



Ref.		€
RACCS6000008	1/2	22,05
RACCS6000012	3/4	28,01
RACCS6000016	1"	31,24
RACCS6000020	1" 1/4	39,56
RACCS6000024	1" 1/2	46,43
RACCS6000032	2"	81,37

**BRIDA ROSCADA BSP SAE 6000 PARA JUNTA**

BSP SAE 6000 THREADED FLANGE FOR O-RING  
BRIDE TARAUDÉE BSP SAE 6000 POUR JOINT



Ref.			€
RACMS6000108	1/2	1/2	33,71
RACMS6000112	3/4	3/4	39,95
RACMS6000116	1"	1"	48,11
RACMS6000120	1" 1/4	1" 1/4	61,17
RACMS6000124	1" 1/2	1" 1/2	91,51
RACMS6000132	2"	2"	133,09

**CONTRABRIDA ROSCADA BSP SAE 6000**

BSP SAE 6000 THREADED COUNTER FLANGE  
CONTRE-BRIDE TARAUDÉE BSP SAE 6000



Ref.			€
RACMS6000008	1/2	1/2	39,60
RACMS6000012	3/4	3/4	46,26
RACMS6000016	1"	1"	55,63
RACMS6000020	1" 1/4	1" 1/4	71,08
RACMS6000024	1" 1/2	1" 1/2	106,64
RACMS6000032	2"	2"	154,75

**BRIDA SOLDAR SAE 6000 PARA JUNTA**

SAE 6000 WELDING FLANGE FOR O-RING  
BRIDE À SOUDER SAE 6000 POUR JOINT



Ref.		€
RACMS6100108	1/2	34,36
RACMS6100112	3/4	40,58
RACMS6100116	1"	48,64
RACMS6100120	1" 1/4	62,66
RACMS6100124	1" 1/2	93,84
RACMS6100132	2"	140,62

**CONTRABRIDA SOLDAR SAE 6000**

SAE 6000 WELDING COUNTER FLANGE  
CONTRE-BRIDE À SOUDER SAE 6000



Ref.		€
RACMS6100008	1/2	34,36
RACMS6100012	3/4	40,58
RACMS6100016	1"	48,64
RACMS6100020	1" 1/4	62,66
RACMS6100024	1" 1/2	93,84
RACMS6100032	2"	140,87

**TAPÓN BRIDA SAE 6000 PARA JUNTA**

SAE 6000 FLANGE PLUG FOR O-RING  
BOUCHON BRIDE SAE 6000 POUR JOINT

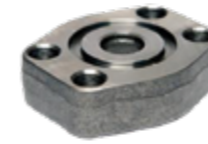

Ref.		€
RACMS6200108	1/2	30,96
RACMS6200112	3/4	30,96
RACMS6200116	1"	34,77
RACMS6200120	1" 1/4	41,88
RACMS6200124	1" 1/2	49,67
RACMS6200132	2"	84,21

**TAPÓN CONTRABRIDA SAE 6000**

SAE 6000 COUNTER FLANGE PLUG  
BOUCHON CONTRE-BRIDE SAE 6000



Ref.		€
RACMS6300108	1/2	35,92
RACMS6300112	3/4	37,66
RACMS6300116	1"	43,62
RACMS6300120	1" 1/4	52,46
RACMS6300124	1" 1/2	61,83
RACMS6300132	2"	99,34

**BRIDA SAE 6000 90° ROSCA BSPP PARA JUNTA**

90° SAE 6000 FLANGE BSPP THREAD FOR O-RING  
BRIDE SAE 6000 90° FILETAGE BSPP POUR JOINT



Ref.			€
RACMS6400108	1/2	1/2	77,32
RACMS6400112	3/4	3/4	88,97
RACMS6400116	1"	1"	104,45
RACMS6400120	1" 1/4	1" 1/4	133,28
RACMS6400124	1" 1/2	1" 1/2	163,23
RACMS6400132	2"	2"	494,94

**BRIDA SAE 6000 90° SOLDAR BSPP PARA JUNTA**

90° SAE 6000 BSPP WELDING FLANGE FOR O-RING  
BRIDE SAE 6000 90° À SOUDER BSPP O-RING



Ref.			€
RACMS6500108	1/2	1/2	73,20
RACMS6500112	3/4	3/4	81,39
RACMS6500116	1"	1"	90,32
RACMS6500120	1" 1/4	1" 1/4	120,13
RACMS6500124	1" 1/2	1" 1/2	146,39
RACMS6500132	2"	2"	496,85

**ESTANQUEIDAD**  
TIGHTNESS  
ÉTANCHÉITÉ



**ARANDELA METAL GOMA BSPP**  
BSPP SEAL  
BAGUE METAL GOMME BSPP

Ref.	Ø	€
RAC60480002	1/8	0,44
RAC60480004	1/4	0,46
RAC60480006	3/8	0,47
RAC60480008	1/2	0,50
RAC60480010	5/8	1,03
RAC60480012	3/4	0,71
RAC60480016	1"	1,17
RAC60480020	1" 1/4	2,37
RAC60480024	1" 1/2	2,86
RAC60480032	2"	4,41



**ARANDELA METAL GOMA MÉTRICA**  
METRIC BONDED SEAL  
BAGUE MÉTRIQUE MÉTAL GOMME

Ref.	Ø	€
RAC60490005	5	0,64
RAC60490006	6	0,64
RAC60490008	8	0,64
RAC60490010	10	0,64
RAC60490012	12	0,70
RAC60490014	14	0,70
RAC60490016	16	0,73
RAC60490018	18	0,73
RAC60490020	20	0,77
RAC60490022	22	0,77
RAC60490024	24	1,03
RAC60490026	26	1,13
RAC60490027	27	1,45

**EXPERTOS EN DISTRIBUCIÓN  
Y EXPERTOS EN SISTEMAS  
HIDRÁULICOS**

**EXPERTS IN DISTRIBUTION & EXPERTS  
IN HYDRAULIC SYSTEMS**

**EXPERTS EN DISTRIBUTION & EXPERTS  
EN SYSTÈMES HYDRAULIQUES**

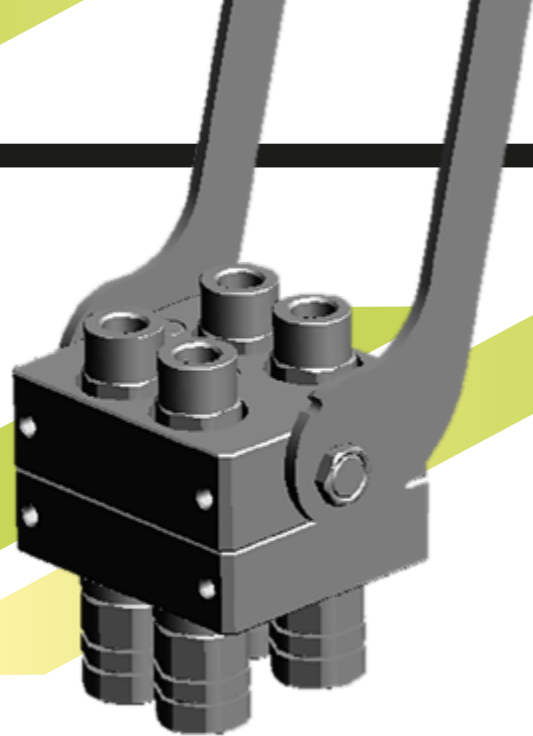

El enchufe rápido es un elemento de conexión que permite un acople rápido y eficiente a la línea de fluido que alimenta el funcionamiento de herramientas y accesorios. Los enchufes rápidos aportan eficiencia, la productividad y la seguridad en los sistemas hidráulicos. En aplicaciones que precisan acoplamientos rápidos, ofrecemos Vincke y Stucchi. Ambas marcas están compuestas por una gama de productos en constante expansión, nuestros enchufes rápidos son sinónimo de calidad y rendimiento. Disponemos de una amplia gama y rápida disponibilidad, lo que facilita soluciones inmediatas y fiables para todo tipo de instalaciones.

The hydraulic quick connector is a component which allows a fast and efficient connection to the fluid line powering tools and accessories. Hydraulic quick release couplings bring efficiency, productivity and safety in hydraulic systems. In operations requiring quick couplings, we offer both Vincke and Stucchi. Both brands comprise a product range in constant expansion and our couplings are synonymous with quality and performance. We offer a wide range with fast availability, ensuring quick response to industrial and maintenance demands.

*Le raccord rapide est un élément de connexion qui permet un couplage rapide et efficace à la ligne de fluide qui alimente le fonctionnement des outils et accessoires. Les raccords rapides apportent efficacité, productivité et sécurité aux systèmes hydrauliques. Pour les applications nécessitant des raccords rapides, nous proposons Vincke et Stucchi. Les deux marques sont composées d'une gamme de produits en constante expansion, nos raccords rapides sont synonymes de qualité et de performance. Nous disposons d'une large gamme et d'une disponibilité rapide, pour répondre efficacement aux besoins industriels et de maintenance.*

## ENCHUFES RÁPIDOS

### QUICK RELEASE COUPLINGS COUPLEURS RAPIDES



Stucchi®



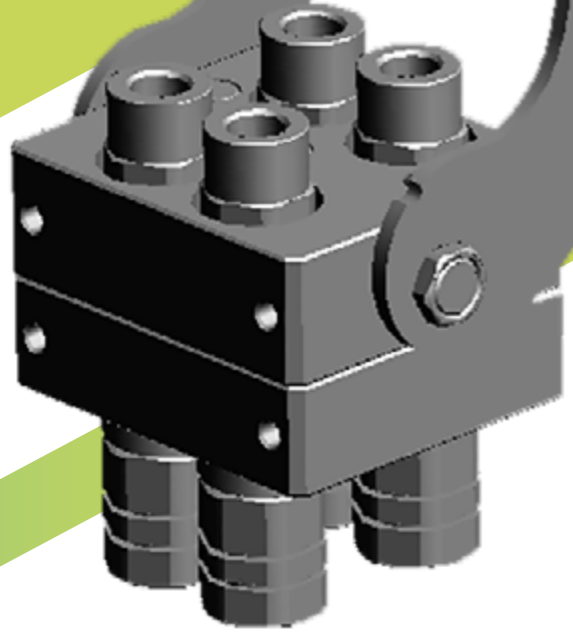

**ENCHUFES RÁPIDOS**  
**QUICK RELEASE COUPLINGS**  
**COUPLEURS RAPIDES**

**01 ENCHUFES RÁPIDOS STUCCHI**  
 QUICK RELEASE COUPLINGS STUCCHI  
 COUPLEURS RAPIDES STUCCHI  
 PÁGINA 206



**02 ENCHUFES RÁPIDOS VINCKE**  
 QUICK RELEASE COUPLINGS VINCKE  
 COUPLEURS RAPIDES VINCKE  
 PÁGINA 216



**ENCHUFES RÁPIDOS STUCCHI**  
**QUICK RELEASE COUPLINGS STUCCHI**  
**COUPLEURS RAPIDES STUCCHI**

**ENCHUFES RÁPIDOS DE CARA PLANA**  
**FLAT FACE QUICK RELEASE COUPLINGS**  
**COUPLEURS RAPIDES FOND PLAT**



**SERIE A ISO 16028 ROSCA BSPP**

A SERIES ISO 16028 BSPP THREAD  
SÉRIE A ISO 16028 FILETAGE BSPP



Ref.	Thread	Type	€
STU0202F	1/8	A4 F	61,53
STU0202M	1/8	A4 M	30,81
STU0204F	1/4	A7 F	68,65
STU0204M	1/4	A7 M	19,48
STU0206F	3/8	A9 F	56,90
STU0206M	3/8	A9 M	22,60
STU0208F	1/2	A9 F	58,14
STU0208M	1/2	A9 M	25,39
STU0208F13	1/2	A13 F	68,34
STU0208M13	1/2	A13 M	44,21

Opcional en Zinc Níquel  
Optional in Zinc Nickel  
Optionnel en Zinc Nickel

**SERIE A ISO 16028 ROSCA BSPP CON JUNTAS DE VITÓN**

A SERIES ISO 16028 BSPP THREAD WITH VITON O-RING  
SÉRIE A ISO 16028 FILETAGE BSPP ET JOINTS VITON



Ref.	Thread	Type	€
STU02V02F	1/8	A4 F	68,74
STU02V02M	1/8	A4 M	34,38
STU02V04F	1/4	A7 F	78,28
STU01V04M	1/4	FIRG14M	22,38
STU02V06F	3/8	A9 F	63,81
STU02V06M	3/8	A9 M	26,76
STU02V08F	1/2	A9 F	64,91
STU02V08M	1/2	A9 M	28,59

**SERIE A ISO 16028 ROSCA SAE/JIC**

A SERIES ISO 16028 SAE/JIC THREAD  
SÉRIE A ISO 16028 FILETAGE SAE/JIC



Ref.	Thread	Type	€
STU02SAE06F	9/16	A9 F	60,44
STU02SAE06M	9/16	A9 M	25,74
STU02SAE08F	3/4	A9 F	61,69
STU02SAE08M	3/4	A9 M	28,25
STU02SAE0908F	7/8	A9 F	79,30
STU02SAE0908M	7/8	A9 M	51,46
STU02SAE10F	7/8	A13 F	79,31

Ref.	Thread	Type	€
STU0212F	3/4	A13 F	69,69
STU0212M	3/4	A13 M	44,12
STU0212F15	3/4	A15 F	132,87
STU0212M15	3/4	A15 M	59,76
STU0216F	1"	A17 F	198,75
STU0216M	1"	A17 M	97,89
STU0220F	1" 1/4	A21 F	255,89
STU0220M	1" 1/4	A21 M	135,00
STU0224F	1" 1/2	A27 F	701,79
STU0224M	1" 1/2	A27 M	375,26

Ref.	Thread	Type	€
STU02V08F13	1/2	A13 F	78,28
STU02V08M13	1/2	A13 M	50,40
STU02V12F	3/4	A13 F	80,95
STU02V12M	3/4	A13 M	51,54
STU02V12F15	3/4	A15 F	156,57
STU02V12M15	3/4	A15 M	69,86
STU02V16F	1"	A17 F	236,68
STU02V16M	1"	A17 M	115,69

Ref.	Thread	Type	€
STU02SAE10M	7/8	A13 M	51,46
STU02SAE1312F	1" 1/16	A13 F	79,31
STU02SAE1312M	1" 1/16	A13 M	51,46
STU02SAE1512F	1" 1/16	A15 F	142,17
STU02SAE1512M	1" 1/16	A15 M	65,33
STU02SAE16F	1" 5/16	A17 F	211,39
STU02SAE16M	1" 5/16	A17 M	105,39



**SERIE A ISO 16028 ROSCA MÉTRICA PASATABIQUE**

A SERIES ISO 16028 BULKHEAD METRIC THREAD  
SÉRIE A ISO 16028 FILETAGE MÉTRIQUE PASSE-CLOISON

Ref.	Ø	Thread	Type	€
STU02M10LSC06F	10	16x150	A9 L10 F	64,75
STU02M10LSC06M	10	16x150	A9 L10 M	29,40
STU02M12LSC08F	12	18x150	A9 L12 F	64,75
STU02M12LSC08M	12	18x150	A9 L12 M	29,40
STU02M15LSC12F	15	22x150	A13 L15 F	79,53
STU02M15LSC12M	15	22x150	A13 L15 M	51,55
STU02M18LSC12F15	18	26x150	A15 L18 F	145,37
STU02M18LSC12M15	18	26x150	A15 L18 M	68,59
STU02M22LSC16F	22	30x200	A17 L22 F	222,99
STU02M22LSC16M	22	30x200	A17 L22 M	110,92
STU02M28LSC20F	28	36x200	A21 L28 F	278,11
STU02M28LSC20M	28	36x200	A21 L28 M	147,58
STU02M10SSC04F	10	18x150	A7 S10 F	76,02

Ref.	Ø	Thread	Type	€
STU02M10SSC04M	10	18x150	A7 S10 M	23,91
STU02M12SSC06F	12	20x150	A9 S12 F	80,61
STU02M12SSC06M	12	20x150	A9 S12 M	52,26
STU02M14SSC12F	14	22x150	A13 S14 F	65,26
STU02M14SSC12M	14	22x150	A13 S14 M	51,55
STU02M16SSC12F15	16	24x150	A15 S16 F	149,73
STU02M16SSC12M15	16	24x150	A15 S16 M	69,52
STU02M20SSC16F	20	30x200	A17 S20 F	222,99
STU02M20SSC16M	20	30x200	A17 S20 M	112,41
STU02M25SSC16F	25	36x200	A17 S25 F	222,99
STU02M25SSC16M	25	36x200	A17 S25 M	112,41
STU02M30SSC20F	30	42x200	A21 S30 F	278,11
STU02M30SSC20M	30	42x200	A21 S30 M	147,58

**SERIE A ISO 16028 ROSCA ORFS PASATABIQUE**

A SERIES ISO 16028 BULKHEAD ORFS THREAD  
SÉRIE A ISO 16028 FILETAGE ORFS PASSE-CLOISON



Ref.	Thread	Type	€
STU02ORFS06F	11/16	A9 F	69,81
STU02ORFS06M	11/16	A9 M	38,92
STU02ORFS10F	1"	A13 F	96,19
STU02ORFS10M	1"	A13 M	62,40

Ref.	Thread	Type	€
STU02ORFS12F	1" 3/16	A13 F	96,19
STU02ORFS12M	1" 3/16	A13 M	62,40
STU02ORFS16F	1" 7/16	A17 F	268,49
STU02ORFS16M	1" 7/16	A17 M	133,86

**SERIES AHD/APM ISO 16028 ROSCA BSPP CONEXION CON PRESIÓN**

AHD/APM SERIES ISO 16028 BSPP THREAD PRESSURE CONNECTION  
SÉRIE AHD/APM ISO 16028 FILETAGE BSPP CONNEXION AVEC PRESION



Ref.	Thread	Type	€
STU0306F	3/8	A9HD	85,23
STU0306M	3/8	APM9 M	68,40
STU0308F	1/2	AHD9 F	87,04
STU0308M	1/2	APM9 M	71,57
STU0308F13	1/2	AHD13 F	101,57
STU0308M13	1/2	APM13 M	85,08

Ref.	Thread	Type	€
STU0312F15	3/4	AHD13 F	108,84
STU0312M15	3/4	APM13 M	86,94
STU0316M	1"	APM17 M	181,84
STU0320M	1" 1/4	APM21 M	412,66
STU0324M	1" 1/2	APM27 M	907,83



**SERIES AHD/APM ISO 16028 ROSCA SAE/JIC CONEXION CON PRESIÓN**

AHD/APM SERIES ISO 16028 SAE/JIC THREAD PRESSURE CONNECTION  
SÉRIES AHD/APM ISO 16028 FILETAGE SAE/JIC CONNEXION AVEC PRESSION

Ref.	Thread	Type	€
STU03SAE0908M	3/4	APM9 M	75,96
STU03SAE10F	7/8	AHD13 F	103,02
STU03SAE10M	7/8	APM13 M	83,66
STU03SAE1312F	1" 1/16	AHD13 F	105,05

Ref.	Thread	Type	€
STU03SAE1312M	1" 1/16	APM13 M	88,78
STU03SAE1512F	1" 1/16	APM15 M	167,48
STU03SAE16M	1" 5/16	APM17 M	197,87

**SERIE HP ROSCA BSPP**

HP SERIES BSPP THREAD  
SÉRIE HP FILETAGE BSPP



Ref.	Thread	Type	€
STU0502F	1/8	A4HP F	115,66
STU0502M	1/8	A4HP M	66,31
STU0504F	1/4	A5HP F	147,48
STU0504M	1/4	A5HP M	59,03
STU0506F	3/8	A5HP F	151,04

Ref.	Thread	Type	€
STU0506M	3/8	A5HP M	62,61
STU0506F9	3/8	A9HP F	195,86
STU0506M9	3/8	A9HP M	118,02
STU0508F	1/2	A9HP F	196,12
STU0508M	1/2	A9HP M	126,74

**SERIE HP ROSCA NPTF**

HP SERIES NPTF THREAD  
SÉRIE HP FILETAGE NPTF



Ref.	Thread	Type	€
STU0504FNPT	1/4	A5HP F	149,33
STU0504MNPT	1/4	A5HP M	48,42
STU0506FNPT	3/8	A5HP F	152,73
STU0506MNPT	3/8	A5HP M	61,82

Ref.	Thread	Type	€
STU0506FNPT9	3/8	A9HP F	189,60
STU0506MNPT9	3/8	A9HP M	116,75
STU0508FNPT	1/2	A9HP F	198,25
STU0508MNPT	1/2	A9HP M	125,13

**SERIE FIRG ISO 16028 ROSCA BSPP**

FIRG SERIES ISO 16028 BSPP THREAD  
SÉRIE FIRG ISO 16028 FILETAGE BSPP



Ref.	Thread	Type	€
STU0104F	1/4	FIRG14 F	40,14
STU0104M	1/4	FIRG14 M	20,16
STU0106F	3/8	FIRG38 F	43,86
STU0106M	3/8	FIRG38 M	22,46
STU0108F	1/2	FIRG12 F	45,22
STU0108M	1/2	FIRG12 M	25,22
STU0108F12A	1/2	FIRG12AF	61,70
STU0108M12A	1/2	FIRG12AM	43,96
STU0112F	3/4	FIRG34 F	63,08
STU0112M	3/4	FIRG34 M	45,08

Ref.	Thread	Type	€
STU0112F34B	3/4	FIRG34B F	96,13
STU0112M34B	3/4	FIRG34B M	61,22
STU0116F	1"	FIRG100 F	167,45
STU0116M	1"	FIRG100 M	93,67
STU0120F	1" 1/4	FIRG114 F	226,36
STU0120M	1" 1/4	FIRG114 M	134,26
STU0124F	1" 1/2	FIRG112 F	602,77
STU0124M	1" 1/2	FIRG112 M	359,84
STU0132F	2"	FIRG200 F	914,61
STU0132M	2"	FIRG200 M	457,13



**SERIE FIRG QV ISO 16028 ROSCA BSPP**

FIRG QV SERIES ISO 16028 BSPP THREAD  
SÉRIE FIRG QV ISO 16028 FILETAGE BSPP

Ref.	Thread	Type	€
STU01QV04F	1/4	FIRG14 QV F	89,85
STU01QV04M	1/4	FIRG14 QV M	33,73
STU01QV06F	3/8	FIRG38 QV F	75,57
STU01QV06M	3/8	FIRG38 QV M	34,51
STU01QV08F	1/2	FIRG12 QV F	78,87

Ref.	Thread	Type	€
STU01QV08M	1/2	FIRG12 QV M	39,52
STU01QV12F	3/4	FIRG34 QV F	176,69
STU01QV12M	3/4	FIRG34 QV M	70,25
STU01QV16F	1"	FIRG100 QV F	222,80
STU01QV16M	1"	FIRG100 QV M	102,86

**SERIE VEP AUTORROSCANTE ROSCA BSPP**

VEP SERIES SCREW BSPP THREAD  
SÉRIE VEP AUTOVISSANTE FILETAGE BSPP



Ref.	Thread	Type	€
STU0604F	1/4	VEP7HD F	119,41
STU0604M	1/4	VEP7HD M	111,94
STU0606F	3/8	VEP9HD F	131,35
STU0606M	3/8	VEP9HD M	149,26
STU0608F13	1/2	VEP13HD F	171,64
STU0608M13	1/2	VEP13HD M	171,64
STU0612F	3/4	VEP13HD F	176,13
STU0612M	3/4	VEP13HD M	176,13
STU0612F15	3/4	VEP15HD F	223,89

Ref.	Thread	Type	€
STU0612M15	3/4	VEP15HD M	201,50
STU0616F	1"	VEP17HD F	283,55
STU0616M	1"	VEP17HD M	231,37
STU0620F	1" 1/4	VEP21HD F	328,36
STU0620M	1" 1/4	VEP21HD M	328,36
STU0624F	1" 1/2	VEP30HD F	858,13
STU0624M	1" 1/2	VEP30HD M	820,84
STU0632F	2"	VEP45HD F	2872,06
STU0632M	2"	VEP45HD M	1887,71

**SERIE VP AUTORROSCANTE ROSCA BSPP**

VP SERIES SCREW BSPP THREAD  
SÉRIE VP AUTOVISSANTE FILETAGE BSPP



Ref.	Thread	Type	€
STU0404F	1/4	VP7 F	75,30
STU0404M	1/4	VP7 M	197,46
STU0406F	3/8	VP9P F	90,38
STU0406M	3/8	VP9P M	277,81
STU0408F	1/2	VP9P F	90,38
STU0408M	1/2	VP9P M	277,81
STU0408F13	1/2	VP13P F	123,85
STU0408M13	1/2	VP13P M	334,56
STU0412F	3/4	VP13P F	123,85

Ref.	Thread	Type	€
STU0412M	3/4	VP13P M	334,56
STU0412F15	3/4	VP15P F	194,18
STU0412M15	3/4	VP15P M	404,93
STU0416F	1"	VP17P F	247,64
STU0416M	1"	VP17P M	532,01
STU0420F	1" 1/4	VP21P F	361,44
STU0420M	1" 1/4	VP21P M	779,63
STU0424F	1" 1/2	VP30P F	894,90
STU0424M	1" 1/2	VP30P M	1773,11

**MULTICONECTORES**  
MULTI-COUPLING PLATES  
MULTI-CONNECTEURS SPÉCIAUX



**SERIE DP ROSCA BSPP**  
DP SERIES BSPP THREAD  
SÉRIE DP FILETAGE BSPP

Ref.	1/2	Type	Elem. Nr.	€
STU500DP208	1/2	DP2	2	783,92
STU500DP408	1/2	DP4	4	1088,63
STU500DPJ308E	1/2	DPJ3	2+1 EC..D	1088,63



**SERIE GR ROSCA BSPP**  
GR SERIES BSPP THREAD  
SÉRIE GR FILETAGE BSPP

Ref.	1/2	Type	Elem. Nr.	€
STU500608	1/2	Gr. 6	6	1641,73
STU501008	1/2	GR10	10	2703,82
STU500408E	1/2	Gr. 5	4+1 EC..D	1721,11



**SERIE FAP9PA ISO 16028 ROSCA BSPP**  
SERIES FAP9PA ISO 16028 BSPP THREAD  
SÉRIE FAP9PA ISO 16028 FILETAGE BSPP

Ref.	1/2	Type	€
STU500008F	1/2	FAP9P F	69,81
STU500008M	1/2	FAP9P M	89,35

**ENCHUFES RÁPIDOS DE BOLA**  
QUICK RELEASE COUPLINGS BALL TYPE  
COUPLEURS RAPIDES À BILLE



**SERIE IR ROSCA BSPP**  
IR SERIES BSPP THREAD  
SÉRIE IR FILETAGE BSPP

Ref.	1/4	Type	€
STU1104F	1/4	IR14 F	20,39
STU1104M	1/4	IR14 M	8,00
STU1106F	3/8	IR38 F	21,13
STU1106M	3/8	IR38 M	9,10
STU1108F	1/2	IR12 F	23,13
STU1108M	1/2	IR12 M	10,425
STU1112F34FA	3/4	IR34 F	45,27
STU1112M34FA	3/4	IR34 M	24,56
STU1116F	1"	IR100 F	63,87
STU1116M	1"	IR100 M	35,87



**SERIE IVHP AUTORROSCANTE ROSCA NPTF**  
IVHP SERIES SCREW NPTF THREAD  
SÉRIE IVHP AUTOVISSANTE FILETAGE NPTF

Ref.	1/4	Type	€
STU05IVHP04F	1/4	IVHP14 F	42,86
STU05IVHP04M	1/4	IVHP14 M	23,51
STU05IVHP06F	3/8	IVHP38 F	41,35
STU05IVHP06M	3/8	IVHP38 M	22,66

**ENCHUFES RÁPIDOS DE PUNZON**  
QUICK RELEASE COUPLINGS POPPET TYPES  
COUPLEURS À CLAPET



**SERIE BIR ISO 7241/A ROSCA BSPP**  
BIR SERIES ISO 7241/A BSPP THREAD  
SÉRIE BIR ISO 7241/A FILETAGE BSPP

Ref.	Ø	Filet	Type	€
STU0904F	1/4		BIR14 F	17,37
STU0904M	1/4		BIR14 M	7,24
STU0906F	3/8		BIR38 F	18,16
STU0906M	3/8		BIR38 M	8,25
STU0908F	1/2		BIR12 F	19,84
STU0908M	1/2		BIR 12 M	7,74
STU0912F	3/4		BIR34 F	42,99
STU0912M	3/4		BIR34 M	21,55
STU0916F	1"		BIR100 F	60,29
STU0916M	1"		BIR100 M	32,45
STU0920F	1" 1/4		BIR114 F	174,04
STU0920M	1" 1/4		BIR114 M	101,34
STU0924F	1" 1/2		BIR112 F	308,05
STU0924M	1" 1/2		BIR112 M	154,11
STU0932F	2"		BIR200 F	607,65
STU0932M	2"		BIR200 M	324,61



**SERIE BIR-PC ISO 7241/A CONEXION CON PRESIÓN ROSCA BSPP**  
BIR-PC SERIES ISO 7241/A PRESSURE CONNECTION BSPP THREAD  
SÉRIE BIR-PC ISO 7241/A CONNEXION AVEC PRESSION FILETAGE BSPP

Ref.	Ø	Type	€
STU09PC08F	1/2	BIR12 PC F	30,29
STU09PC08M	1/2	BIR12 PC M	15,56



**SERIE I ISO 7241/A PUSH PULL ROSCA MÉTRICA**  
SERIES I ISO 7241/A PUSH-PULL METRIC THREAD  
SÉRIE I ISO 7241/A PUSH PULL FILETAGE MÉTRIQUE

Ref.	Ø	Filet	Type	€
STU1312L08F	12	18x150	I12 18150 F	38,35
STU1312L08M	12	18x150	I12 18150 M	15,56
STU1315L08F	15	22x150	I12 22150 F	38,35
STU1315L08M	15	22x150	I12 22150 M	15,56



**SERIE I ISO 7241/A PUSH PULL ROSCA MÉTRICA PASATABIQUE**  
I SERIES ISO 7241/A PUSH-PULL BULKHEAD METRIC THREAD  
SÉRIE I ISO 7241/A PUSH PULL FILETAGE MÉTRIQUE PASSE CLOISON

Ref.	Ø	Filet	Type	€
STU1312L08FSC	12	18x150	I12SC 18150 F	42,57
STU1312L08MSC	12	18x150	I12SC 18150 M	17,55
STU1315L08FSC	15	22x150	I12SC 22150 F	42,57
STU1315L08MSC	15	22x150	I12SC 22150 M	20,34



**SERIE IR/V ROSCA BSPP**  
IR/V SERIES BSPP THREAD  
SÉRIE IR/V FILETAGE BSPP

Ref.	Ø	Type	€
STU11V04F	1/4	IR14V F	19,45
STU11V04M	1/4	IR14V M	7,90
STU11V06F	3/8	IR38V F	20,28
STU11V06M	3/8	IR38V M	8,57
STU11V12F34FA	3/4	IR34V F	44,77
STU11V12M34FA	3/4	IR34V M	22,20
STU11V16F	1"	IR100V F	65,11
STU11V16M	1"	IR100V M	35,61



**SERIE IP-IRSVa ISO 7241/A PUSH PULL ROSCA BSPP**  
IP-IRSVa SERIES ISO 7241/A PUSH PULL BSPP THREAD  
SÉRIE IP-IRSVa ISO 7241/A PUSH PULL FILETAGE BSPP

Ref.	Ø	Type	€
STU1204FVA	1/4	I-IP14 F	37,66
STU1204MVA	1/4	I-IP14 M	19,98
STU1206FVA	3/8	I-IP38 F	35,89
STU1206MVA	3/8	I-IP38 M	18,37
STU1208FVA	1/2	I-IP12 F	22,76
STU0908M	1/2	BIR 12 M	7,74
STU1212FVA	3/4	I-IP34 F	95,44
STU1212MVA	3/4	I-IP34 M	47,22
STU1216FVA	1"	I-IP100 F	109,19
STU1216MVA	1"	I-IP100 M	56,84



**SERIE IRS12Va ISO 7241/A PUSH PULL CONEXIÓN CON PRESIÓN ROSCA BSPP**  
IRS12Va SERIES ISO 7241/A PUSH PULL PRESSURE CONNECTION BSPP THREAD  
SÉRIE IRS12Va ISO 7241/A PUSH PULL CONNEXION AVEC PRESSION FILETAGE BSPP

Ref.	Ø	Type	€
STU12PC08FVA	1/2	IRS/12 PC F	34,46
STU09PC08M	1/2	BIR12 PC M	15,56

**ACCESORIOS DE ENCHUFES RÁPIDOS**  
QUICK RELEASE ACCESSORIES  
ACCESOIRES DE COUPLEURS RAPIDES



**SERIE B ISO 7241/B ACERO ROSCA BSPP**  
B SERIES ISO 7241/B STEEL BSPP THREAD  
SÉRIE B ISO 7241/B ACIER FILETAGE BSPP

Ref.		Type	€
STU1002F	1/8	IRB18 F	30,14
STU1002M	1/8	IRB18 M	13,79
STU1004F	1/4	IRB14 F	25,60
STU1004M	1/4	IRB14 M	11,68
STU1006F	3/8	IRB38 F	28,55
STU1006M	3/8	IRB38 M	12,52
STU1008F	1/2	IRB12 F	36,10
STU1008M	1/2	IRB12 M	13,11
STU1012F	3/4	IRB34 F	63,83
STU1012M	3/4	IRB34 M	29,68
STU1016F	1"	IRB100 F	98,25
STU1016M	1"	IRB100 M	43,98



**SERIE B ISO 7241/B LATON Y JUNTA VITÓN ROSCA BSPP**  
B SERIES ISO 7241/B BRASS AND VITON O-RINGS BSPP THREAD  
SÉRIE B ISO 7241/B LAITON ET JOINT VITON FILETAGE BSPP

Ref.		Type	€
STU10LV02F	1/8	IRBO18 F	53,55
STU10LV02M	1/8	IRBO18 M	24,53
STU10LV04F	1/4	IRBO14 F	42,45
STU10LV04M	1/4	IRBO14 M	20,42
STU10LV06F	3/8	IRBO38 F	56,91
STU10LV06M	3/8	IRBO38 M	22,88
STU10LV08F	1/2	IRBO12 F	72,15
STU10LV08M	1/2	IRBO12 M	26,46
STU10LV12F	3/4	IRBO34 F	122,45
STU10LV12M	3/4	IRBO34 M	70,37
STU10LV16F	1"	IRBO100 F	195,78
STU10LV16M	1"	IRBO100 M	106,29

**ENCHUFES RÁPIDOS VÁLVULA DE FRENAJE SERIE IFR**  
IFR SERIES QUICK RELEASE COUPLINGS BRAKE VALVE  
COUPLEURS RAPIDES VALVE DE FREINAGE SÉRIE IFR



Ref.		Type	€
STU3406F	3/8	IFR838 F	34,76
STU3408F	1/2	IFR812 F	34,76
STU3418150F	18x150	IFR818150 F	34,76
STU3408M	1/2	IFR812 M	33,61



**TAPONES PLÁSTICO PVC ROJO PARA ENCHUFE SERIE FIRG, A, QV, AHD, APM, FL**  
READ PVC PLASTIC PLUGS SERIES FIRG, A, QV, AHD, APM, FL COUPLING  
BOUCHONS PLASTIQUE PVC ROUGE COUPLEUR SÉRIE FIRG, A, QV, AHD, APM, FL

Ref.	Type	€
STU1504F	TF FIRG14/A7	2,56
STU1504M	TM FIRG14/A7	2,56
STU1506F	TF FIRG38-12/A9	2,77
STU1506M	TM FIRG38-12/A9	2,77
STU1512F	TF FIRG34/A13	3,14
STU1512M	TM FIRG34/A13	3,14
STU1512F34B	TF FIRG34B/A15	3,91
STU1512M34B	TM FIRG34B/A15	3,90
STU1516F	TF FIRG100/A17	4,91
STU1516M	TM FIRG100/A17	4,91
STU1520F	TF FIRG114/A21	5,73
STU1520M	TM FIRG114/A21	5,73



**KITS DE JUNTAS PARA ENCHUFE SERIES A, FIRG**  
SEALS KITS SERIES A FIRG COUPLING  
KIT DE JOINTS COUPLEUR SÉRIE A, FIRG

Ref.	Type	€
STU3204	JNFIRG-A7	3,43
STU3206	JNFIRG-A9	4,74
STU3208	JNFIRG-A13	15,90
STU3212	JNFIRG-A15	6,42
STU3216	JNFIRG-A17	11,83
STU3220	JNFIRG-A21	17,78



**KITS DE JUNTAS PARA ENCHUFE BIR**  
SEALS KIT SERIES BIR  
KIT DE JOINTS COUPLEUR SÉRIE BIR

Ref.	Type	€
STU3104	JNBIR 1/4	2,09
STU3106	JNBIR 3/8	3,43
STU3108	JNBIR 1/2	2,36
STU3112	JNBIR 3/4	2,79
STU3116	JNBIR 1"	16,69

**ENCHUFES RÁPIDOS VINCKE**  
**QUICK RELEASE COUPLINGS VINCKE**  
**COUPLEURS RAPIDES VINCKE**

**ENCHUFES RÁPIDOS DE PUNZON VINCKE**  
**VINCKE QUICK RELEASE COUPLINGS POPPET TYPES**  
**COUPLEURS RAPIDES À CLAPET VINCKE**

**SERIE VSA ISO 7241/A ROSCA BSPP**

VSA SERIES ISO 7241/A BSPP THREAD  
SÉRIE VSA ISO 7241/A FILETAGE BSPP



Ref.		Type	€
VNKEN0904F	1/4	VSA 14 F	16,15
VNKEN0904M	1/4	VSA 14 M	6,73
VNKEN0906F	3/8	VSA 38 F	16,88
VNKEN0906M	3/8	VSA 38 M	7,67
VNKEN0908F	1/2	VSA 12 F	17,83
VNKEN0908M	1/2	VSA 12 M	6,96
VNKEN0912F	3/4	VSA 34 F	39,96
VNKEN0912M	3/4	VSA 34 M	20,03
VNKEN0916F	1"	VSA 100 F	56,03
VNKEN0916M	1"	VSA 100 M	30,16
VNKEN0920F	1 1/4	VSA 114 F	115,27
VNKEN0920M	1 1/4	VSA 114 M	67,55
VNKEN0924F	1 1/2	VSA 112 F	205,37
VNKEN0924M	1 1/2	VSA 112 M	102,74

**SERIE VSA-PC ISO 7241/A ROSCA BSPP CONEX.PRES.**

VSA-PC SERIES ISO 7241/A BSPP THREAD CONNEX. PRESS.  
SÉRIE VSA-PC ISO 7241/A FILETAGE BSPP CONN. PRES.



Ref.		Type	€
VNKEN09PC08F	1/2	VSA-PC 12 F	29,73
VNKEN09PC08M	1/2	VSA-PC 12 M	15,25

**SERIE VSP ISO 7241/A PUSH-PULL ROSCA BSPP**

VSP ISO 7241/A PUSH-PULL SERIES 1/2 BSPP THREAD  
SÉRIE VSP ISO 7241/A PUSH-PULL FILETAGE BSPP



Ref.		Type	€
VNKEN1208FVA	1/2	VSP 12 F	22,32

**SERIE VSP-PC ISO 7241/A PUSH-PULL ROSCA BSPP CONEXION PRES.**

VSP-PC ISO 7241/A PUSH-PULL SERIES BSPP THREAD CONNEX. PRESS.  
SÉRIE VSP-PC ISO 7241/A PUSH-PULL FILETAGE BSPP CONN. PRES.



Ref.		Type	€
VNKEN12PC08FVA	1/2	VSP-PC 12 F	33,81

**SERIE VSM ISO 7241/A PUSH-PULL ROSCA METRICA VINCKE**  
**VSM ISO 7241/A PUSH-PULL SERIES METRICA THREAD VINCKE**  
**SERIE VSM ISO 7241/A PUSH-PULL FILETAGE METRIC VINCKE**

**SERIE VSM ISO 7241/A PUSH-PULL ROSCA METRICA**

VSM ISO 7241/A PUSH-PULL SERIES METRICA THREAD  
SÉRIE VSM ISO 7241/A PUSH-PULL FILETAGE METRIC



Ref.		Type	€
VNKEN1310L08F	16x150	VSM 16 F	21,20
VNKEN1310L08M	16x150	VSM 16 M	8,15
VNKEN1312L08F	18x150	VSM 18 F	21,20
VNKEN1312L08M	18x150	VSM 18 M	8,15
VNKEN1315L08F	22x150	VSM 22 F	21,20
VNKEN1315L08M	22x150	VSM 22 M	8,15

**SERIE VSM ISO 7241/A PUSH-PULL ROSCA METRICA PASATABIQUE**

VSM ISO 7241/A PUSH-PULL SERIES METRICA THREAD BULKHEAD  
SÉRIE VSM ISO 7241/A PUSH-PULL FILETAGE METRIC PASSE-CLOISON



Ref.		Type	€
VNKEN1310L08FSC	16x150	VSM-SC 16 F	23,64
VNKEN1310L08MSC	16x150	VSM-SC 16 M	8,93
VNKEN1312L08FSC	18x150	VSM-SC 18 F	23,64
VNKEN1312L08MSC	18x150	VSM-SC 18 M	8,93
VNKEN1315L08FSC	22x150	VSM-SC 22 F	23,64
VNKEN1315L08MSC	22x150	VSM-SC 22 M	8,93
VNKEN1312SPC08FSC	20x150	VSM-SC 20 F	29,26
VNKEN1312SPC08MSC	20x150	VSM-SC 20 M	12,55

**SERIE VCFPV ISO 7241/A PUSH-PULL**

VCFPV ISO 7241/A PUSH-PULL SERIES  
SÉRIE VCFPV ISO 7241/A PUSH-PULL



Ref.		Type	€
VNKEN2008F	1/2	VCFPV 12 F	89,95
VNKEN202215F	22x150	VCFPV 22150 F	96,38

**SERIE VNV ISO 5675 ROSCA BSPP**

VNV SERIES ISO 5675 BSPP THREAD  
SÉRIE VNV ISO 5675 FILETAGE BSPP



Ref.		Type	€
VNKEN11V04F	1/4	VNV 14 F	18,70
VNKEN11V04M	1/4	VNV14 M	7,60
VNKEN11V06F	3/8	VNV 38 F	19,50
VNKEN11V06M	3/8	VNV 38 M	8,23
VNKEN11V12F	3/4	VNV 34 F	43,06
VNKEN11V12M	3/4	VNV 34 M	21,36
VNKEN11V16F	1"	VNV 100 F	62,62
VNKEN11V16M	1"	VNV 100 M	34,25



**SERIE VSBL ISO 7241/B ROSCA BSPP LATON**

VSBL ISO 7241/B SERIES BSPP THREAD BRASS  
SÉRIE VSBL ISO 7241/B FILETAGE BSPP LAITON

Ref.		Type	€
VNKEN10LV04F	1/4	VSBL 14 F	41,64
VNKEN10LV04M	1/4	VSBL 14 M	20,04
VNKEN10LV06F	3/8	VSBL 38 F	55,84
VNKEN10LV06M	3/8	VSBL 38 M	22,45
VNKEN10LV08F	1/2	VSBL 12 F	70,77
VNKEN10LV08M	1/2	VSBL 12 M	25,95
VNKEN10LV12F	3/4	VSBL 34 F	120,13
VNKEN10LV12M	3/4	VSBL 34 M	69,03
VNKEN10LV16F	1"	VSBL 100 F	192,06
VNKEN10LV16M	1"	VSBL 100 M	104,26



**SERIE VSG AUTORROSCANTE ROSCA BSPP**

VSG SERIES SCREW COUPLING BSPP THREAD  
SERIE VSG FILETAGE BSPP A VISSER

Ref.		Type	€
VNKEN2104F	1/4	VSG 14 F	15,78
VNKEN2104M	1/4	VSG 14 M	8,11
VNKEN2106F	3/8	VSG 38 F	17,28
VNKEN2106M	3/8	VSG 38 M	11,70
VNKEN2108F	1/2	VSG 12 F	24,18
VNKEN2108M	1/2	VSG 12 M	14,63
VNKEN2112F	3/4	VSG 34 F	43,44
VNKEN2112M	3/4	VSG 34 M	25,06
VNKEN2116F	1"	VSG 100 F	64,53
VNKEN2116M	1"	VSG 100 M	37,04



**SERIE VST-TC ROSCA BSPP**

VST-TC SERIES BSPP THREAD  
SÉRIE VST-TC FILETAGE BSPP

Ref.		Type	€
VNKEN1906F	1/2	VST-PC 12 F	43,39
VNKEN1906M	1/2	VST-PC 12 M	18,27
VNKEN1908F	1/2	VST-PC 12 F	43,71
VNKEN1908M	1/2	VST-PC 12 M	18,85
VNKEN1912F	3/4	VST-PC 34 F	71,80
VNKEN1912M	3/4	VST-PC 34 M	36,23
VNKEN1916F	1"	VST-PC 100 F	85,62
VNKEN1916M	1"	VST-PC 100 M	50,04



**SERIE VSR AUTORROSCANTE ROSCA BSPP**

VSR SERIES SCREW COUPLING BSPP THREAD  
SERIE VSR À VISSER FILETAGE BSPP

Ref.		Type	€
VNKEN1812F	3/4	VSR 34 F	42,09
VNKEN1812M	3/4	VSR 34 M	39,32
VNKEN1816F	1"	VSR 100 F	54,36
VNKEN1816M	1"	VSR 100 M	50,87



**SERIE VSV ISO 14541 AUTORROSCANTE ROSCA BSPP**

VSV ISO 14541 SERIES SCREW COUPLING BSPP THREAD  
SERIE VSV ISO 14541 FILETAGE BSPP A VISSER

Ref.		Type	€
VNKEN1404F	1/4	VSV 14 F	25,60
VNKEN1404M	1/4	VSV 14 M	31,66
VNKEN1406F	3/8	VSV 38 F	26,78
VNKEN1406M	3/8	VSV 38 M	30,76
VNKEN1408F	1/2	VSV 12 F	28,63
VNKEN1408M	1/2	VSV 12 M	27,54
VNKEN1412F	3/4	VSV 34 F	63,47
VNKEN1412M	3/4	VSV 34 M	66,05
VNKEN1416F	1"	VSV 100 F	68,83
VNKEN1416M	1"	VSV 100 M	72,63
VNKEN1420F	1" 1/4	VSV 114 F	210,88
VNKEN1420M	1" 1/4	VSV 114 M	297,45

**ENCHUFES RÁPIDOS DE BOLA VINCKE**  
QUICK RELEASE COUPLINGS BALL TYPE VINCKE  
COUPLEURS RAPIDES À BILLE VINCKE

**SERIE VNS ISO 5675 ROSCA BSPP**  
VNS SERIES ISO 5675 BSPP THREAD  
SERIES VNS FILETAGE BSPP



Ref.		Type	€
VNKEN1104F	1/4	VNS 14 F	19,60
VNKEN1104M	1/4	VNS 14 M	7,70
VNKEN1106F	3/8	VNS 38 F	20,32
VNKEN1106M	3/8	VNS 38 M	8,76
VNKEN1108F	1/2	VNS 12 F	22,23
VNKEN1108M	1/2	VNS 12 M	10,02
VNKEN1112F	3/4	VNS 34 F	43,53
VNKEN1112M	3/4	VNS 34 M	23,62
VNKEN1116F	1"	VNS 100 F	61,42
VNKEN1116M	1"	VNS 100 M	34,48

**SERIE VHP ROSCA NPT**  
VHP SERIES THREAD NPT  
SERIES VHP FILETAGE NPT



Ref.		Type	€
VNKEN0506F	3/8	VHP 38 F	39,76
VNKEN0506M	3/8	VHP 38 M	21,79

**ENCHUFE RAPIDO CONTROL PRESION**  
QUICK RELEASE COUPLINGS CONTROL PRESSURE  
COUPLEURS RAPIDES CONTRÔLE DE PRESSION

**ENCHUFE VSV CONTROL PRESION**  
QRC VDS CONTROL PRESS. 1/8 BSP FEMALE  
COUPLEURS RAPIDES CONTRÔLE DE PRESSION



Ref.		Type	€
VNKEN2202MF	1/8	VSD 1/8 MH BSP	18,95
VNKEN2202FNPT	1/8	VSD 1/8 F NPTF	41,74
VNKEN2202MFNPT	1/8	VSD 1/8 MH NPTF	18,95
VNKEN2204FMNPT	1/4	VSD 1/4 MH NPTF	41,76
VNKEN2204FNPT	1/4	VSD 1/4 F NPTF	41,76
VNKEN2204MNPT	1/4	VSD 1/4 NPT M	18,95
VNKEN22141504M	M14150	VSD M14150 M	18,95
VNKEN2271604M	7/16	VSD 7/16 UNF M	18,95
VNKEN2291604M	9/16	VSD 9/16 UNF M	18,94

**ENCHUFES RÁPIDOS DE FRENO**  
QUICK RELEASE COUPLINGS BRAKE VALVES  
COUPLEURS RAPIDES DE FREINAGE

**SERIE VVF VÁLVULA DE FRENAJE HEMBRA**  
VVF SERIES QUICK RELEASE COUPLINGS BRAKE VALVE  
SÉRIE VVF VALVE DE FREINAGE FEMELLE



Ref.		Type	€
VNKEN3406F	3/8	VVF 38 F	32,29
VNKEN3408F	1/2	VVF 12 F	32,29
VNKEN3408M	1/2	VVF 12 M	15,79
VNKEN341815F	18x150	VVF 18 F	32,29
VNKEN341815M	18x150	VVF 18M	15,79

**SERIE VVA VÁLVULA AGRÍCOLA**  
VVA SERIES SCREW VALVE  
SÉRIE VVA VALVE AGRICOLE



Ref.		Type	€
VNKEN3506F	3/8	VVA 38 F	32,13
VNKEN3508M	1/2	VVA 38 M	22,47
VNKEN351815F	18x150	VVA 18150 F	32,13
VNKEN351815M	18x150	VVA 18150 M	22,47

**SERIES VVA + VSA ISO 7241/A VINCKE**  
VVA + VSA ISO 7241/A SERIES VINCKE  
SÉRIE VVA VALVE + VSA ISO 7241/A VINCKE

**SERIES VVA HEMBRA + VSA HEMBRA**  
VVA FEMALE + VSA ISO 7241/A SERIES FEMALE  
SÉRIE VVA VALVE FEMELLE + VSA ISO 7241/A FEMELLE



Ref.			Type	€
VNKEN350908F	18x150	1/2	VVA 18150 F VSA 12 F	52,66

**SERIES VVA MACHO + VSA ISO 7241/A MACHO**  
VVA MALE + VSA ISO 7241/A SERIES MALE  
SÉRIE VVA VALVE MALE + VSA ISO 7241/A MALE



Ref.			Type	€
VNKEN350908MC	18x150	1/2	VVA M VSA 12 M CORTO	18,05
VNKEN350908ML	18x150	1/2	VVA M VSA 12 M LARGO	36,29

**ACCESORIOS DE ENCHUFES RÁPIDOS VINCKE**  
QUICK RELEASE ACCESORIES VINCKE  
ACCESSOIRES POUR COUPLEURS RAPIDES VINCKE

**EMPUÑADURA PARA ENCHUFE RAPIDO**

HAND GRIP QUICK RELEASE QRC  
POIGNÉE COUPLEUR



Ref.		Type	€
VNKEN2408F	1/2	VHG 12	19,72

**ANILLO PARA EMPUÑADURA**

RING IDENTIFICATION HAND GRIP  
BAGUES D'IDENTIFICATION POIGNÉE COULEURS



Ref.		Type	€
VNKEN2408FB	BLUE	VHG 12	1,97
VNKEN2408FG	GREEN	VHG 12	1,97
VNKEN2408FR	RED	VHG 12	1,97
VNKEN2408FY	YELLOW	VHG 12	1,97

**TAPON PARKING SERIES VSA, VSA-PC**

PARKING CAP VSA, VSA-PC SERIES  
BOUCHON PARKING SERIE VSA, VSA-PC



Ref.		Type	€
VNKEN15PVSA08F	18x150	MCA 12 F	5,00
VNKEN15TA08FR	RED	NCA 12 FR	9,13
VNKEN15TA08FK	BLUE	NCA 12 FB	9,13
VNKEN15TA08FY	YELLOW	NCA 12 FY	9,13

**TAPONES PLASTICO SERIES VSA, VSA-PC, VSP, VSP-PC, VCFPV**

PLASTIC CAPS VSA, VSA-PC, VSP, VSP-PC, VCFPV SERIES  
BOUCHONS PLASTIQUE SERIES VSA, VSA-PC, VSP, VSP-PC, VCFPV



Ref.	Type	€	Ref.	Type	€
VNKEN15TVSA04FR	VSA 14 FR	1,22	VNKEN15TVSA08FO	VSA 12FB	1,39
VNKEN15TVSA04MR	VSA 14 MR	1,22	VNKEN15TVSA08MB	VSA 12FO	1,39
VNKEN15TVSA06FR	VSA 38 FR	1,30	VNKEN15TVSA08MY	VSA 12MB	1,39
VNKEN15TVSA06MR	VSA 38 MR	1,39	VNKEN15TVSA08MR	VSA 12 MR	1,39
VNKEN15TVSA08FR	VSA 12 FR	1,39	VNKEN15TVSA12FR	VSA 34 FR	2,15
VNKEN15TVSA08FB	VSA 12 FB	1,39	VNKEN15TVSA12MR	VSA 34 MR	2,15
VNKEN15TVSA08FY	VSA 12FY	1,39	VNKEN15TVSA16FR	VSA 100 FR	2,61
VNKEN15TVSA08FK	VSA 12FK	1,39	VNKEN15TVSA16MR	VSA 100 MR	2,61

**TAPONES PLASTICO SERIES VNV, VNS**

VNV VNS SERIES PLASTIC CAPS  
BOUCHONS PLASTIQUE SERIES VNV, VNS



Ref.	Type	€
VNKEN15TVNV04FR	VNV 14 FR	2,59
VNKEN15TVNV04MR	VNV 14 MR	2,59
VNKEN15TVNV06FR	VNV 38 FR	3,62
VNKEN15TVNV06MR	VNV 38 MR	3,62
VNKEN15TVNV12FR	VNV 34 FR	4,22
VNKEN15TVNV12MR	VNV 34 MR	4,22
VNKEN15TVNV16FR	VNV 100 FR	5,72
VNKEN15TVNV16MR	VNV 100 MR	5,72

**TAPONES PLASTICO SERIES VSB**

VSB SERIES PLASTIC CAPS  
BOUCHONS PLASTIQUE VSB SERIES



Ref.	Type	€
VNKEN15TVSB06FB	VSB 38 FB	3,11
VNKEN15TVSB04MB	VSB 14 MB	2,59
VNKEN15TVSB06FB	VSB 38 FB	3,11
VNKEN15TVSB06MB	VSB 38 MB	2,93
VNKEN15TVSB08FB	VSB 12 FB	3,97
VNKEN15TVSB08MB	VSB 12 MB	3,62
VNKEN15TVSB12FB	VSB 34 FB	5,52
VNKEN15TVSB12MB	VSB 34 MB	4,83
VNKEN15TVSB16FB	VSB 100 FB	6,55
VNKEN15TVSB16MB	VSB 100 MB	5,52

**TAPONES PLASTICO VST SERIES**

VST SERIES PLASTIC CAPS VST  
BOUCHONS PLASTIQUE VST SERIES



Ref.	Type	€
VNKEN15TVST06FR	VST 38 FR	4,48
VNKEN15TVST06MR	VST 38 MR	4,66
VNKEN15TVST08FR	VST 12 FR	4,66
VNKEN15TVST08MR	VST 12 MR	5,86
VNKEN15TVST12FR	VST 34 FR	6,90
VNKEN15TVST12MR	VST 34 MR	7,07
VNKEN15TVST16FR	VST 100 FR	9,66
VNKEN15TVST16MR	VST 100 MR	11,04

**TAPONES PLASTICO VSV SERIES**

VSV SERIES PLASTIC CAPS  
BOUCHONS PLASTIQUE VSV SERIES



Ref.	Type	€
VNKEN15TVSV04FR	VSV 14 FR	8,01
VNKEN15TVSV04MR	VSV 14 MR	8,01
VNKEN15TVSV06FR	VSV 38 FR	8,01
VNKEN15TVSV06MR	VSV 38 MR	8,01
VNKEN15TVSV08FR	VSV 12 FR	8,01
VNKEN15TVSV08MR	VSV 12 MR	8,01
VNKEN15TVSV12FR	VSV 34 FR	12,74
VNKEN15TVSV12MR	VSV 34 MR	12,74
VNKEN15TVSV16FR	VSV 100 FR	10,11
VNKEN15TVSV16MR	VSV 100 MR	10,11
VNKEN15TVSV20FR	VSV 114 FR	19,68
VNKEN15TVSV20MR	VSV 114 MR	17,72

**TAPONES PLASTICO VSG SERIES**

VSG SERIES PLASTIC CAPS  
BOUCHONS PLASTIQUE VSG SERIES



Ref.	Type	€
VNKEN15TVSG04FR	VSG 14 FR	13,35
VNKEN15TVSG04MR	VSG 14 MR	13,35
VNKEN15TVSG06FR	VSG 38 FR	16,04
VNKEN15TVSG06MR	VSG 38 MR	16,04
VNKEN15TVSG08FR	VSG 12 FR	22,77
VNKEN15TVSG08MR	VSG 12 MR	23,49
VNKEN15TVSG12FR	VSG 34 FR	28,88
VNKEN15TVSG12MR	VSG 34 MR	32,60
VNKEN15TVSG16FR	VSG 100 FR	44,30
VNKEN15TVSG16MR	VSG 100 MR	54,65

**TAPONES METAL VSR SERIES**

VSR SERIES METALIC CAPS  
BOUCHONS METALIQUES VSR SERIE



Ref.	Type	€
VNKEN15TVSR12F	VSR 34 FR	32,77
VNKEN15TVSR12M	VSR 34 MR	32,77
VNKEN15TVSR16F	VSR 100 FR	37,95
VNKEN15TVSR16M	VSR 100 MR	37,95

**TAPONES PLASTICO SERIES VHP**

SERIES PLASTIC CAPS VHP  
BOUCHONS PLASTIQUE VHP SERIES



Ref.	Type	€
VNKEN15TVHP06FK	VHP 38 FK	13,06
VNKEN15TVHP06MK	VHP 38 MK	13,06

**TAPONES PLASTICO VVF SERIES**

VVF SERIES PLASTIC CAPS  
BOUCHONS PLASTIQUE VVF SERIES



Ref.	Type	€
VNKEN15TVVF08F	VVF 08	10,88

**TAPONES PLASTICO VVA SERIES**

VVA SERIES PLASTIC CAPS  
BOUCHONS PLASTIQUE VVA SERIES



Ref.	Type	€
VNKEN15TVVA08F	VVA 08	9,76

**UTILIZA NUESTRA TIENDA ONLINE**  
**USE OUR ONLINE STORE**  
**UTILISEZ NOTRE BOUTIQUE EN LIGNE**

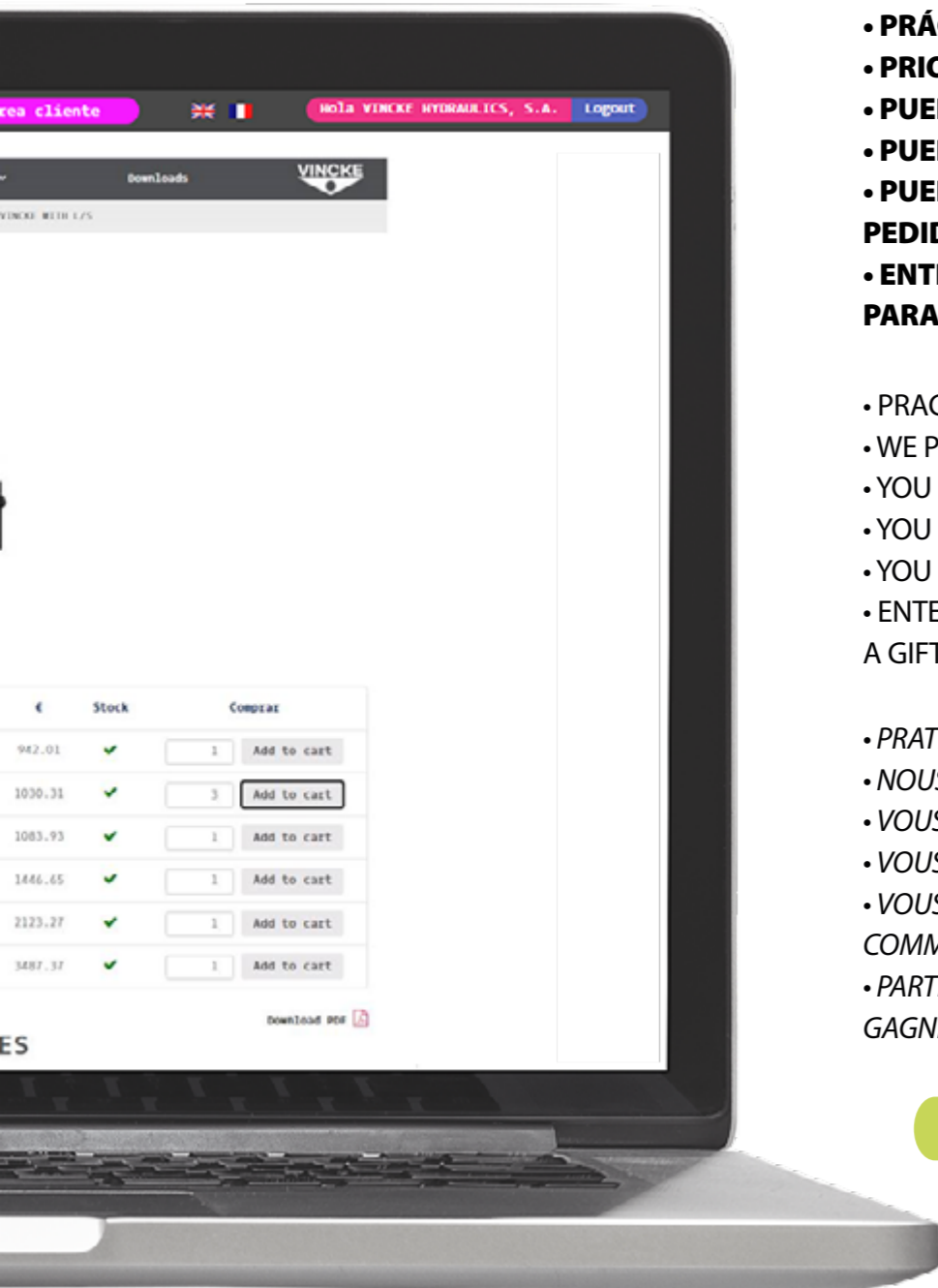

- PRÁCTICA Y RÁPIDA.
- PRIORIZAMOS TUS PEDIDOS.
- PUEDES VER NUESTRO STOCK.
- PUEDES VER TU PRECIO ACTUALIZADO.
- PUEDES VER LA SITUACIÓN DEL PEDIDO.
- ENTRA EN EL CONCURSO MENSUAL PARA GANAR UN CUPÓN REGALO.

- PRACTICAL AND FAST.
- WE PRIORITIZE YOUR ORDERS.
- YOU CAN CHECK OUR STOCK.
- YOU CAN SEE YOUR UPDATED PRICE.
- YOU CAN TRACK THE ORDER STATUS.
- ENTER THE MONTHLY CONTEST TO WIN A GIFT VOUCHER.

- PRATIQUE ET RAPIDE.
- NOUS PRIORISONS VOS COMMANDES.
- VOUS POUVEZ CONSULTER NOTRE STOCK.
- VOUS POUVEZ VOIR VOTRE PRIX ACTUALISÉ.
- VOUS POUVEZ SUIVRE L'ETAT DE LA COMMANDE.
- PARTICIPEZ AU CONCOURS MENSUEL POUR GAGNER UN BON DE REDUCTION.

[www.vinckehydraulics.com](http://www.vinckehydraulics.com)

**ALCANZAMOS NUESTROS  
OBJETIVOS JUNTOS**

**WE REACH OUR GOALS TOGETHER**

**NOUS ATTEIGNONS NOS  
OBJECTIFS ENSEMBLE**

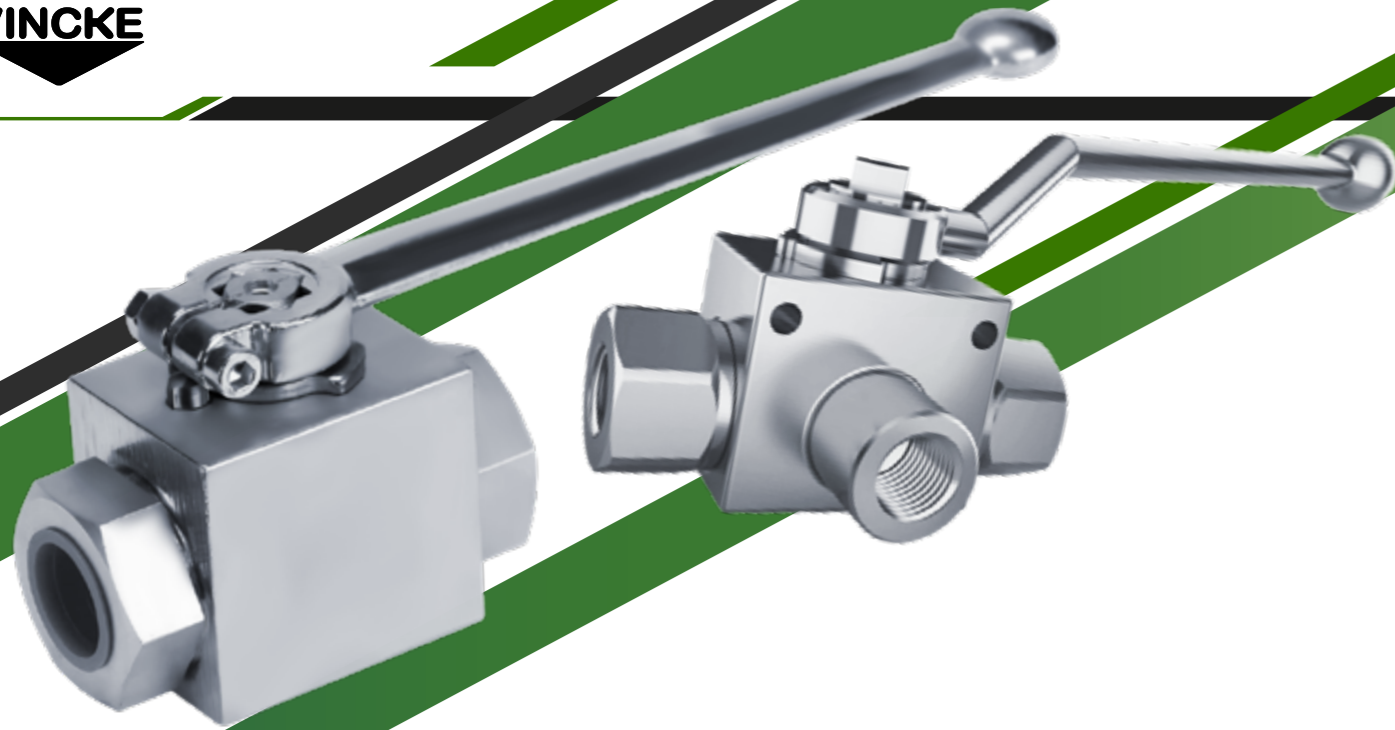

Las válvulas de bola Vincke se utilizan para cerrar y desviar el flujo en sistemas de tuberías hidráulicas a presiones de hasta 500 bar y, por lo tanto, evitan la necesidad de convertir o desinstalar componentes.

Las válvulas de bola Vincke cumplen con los requisitos de todas las normas y reglamentos de seguridad en cuanto a resistencia y rendimiento de sellado.

Vincke ball valves are designed to shut off or divert hydraulic flow at pressures up to 500 bar, without disassembling components.

We offer a wide range with fast availability, providing immediate and reliable solutions for all types of hydraulic systems.

*Les vannes à boisseau sphérique Vincke sont conçues pour interrompre ou rediriger le flux dans des systèmes hydrauliques jusqu'à 500 bar, sans démontage.*

*Nous offrons une large gamme avec une disponibilité rapide, garantissant des solutions fiables et immédiates pour tous les systèmes hydrauliques.*

## VÁLVULAS HIDRAULICAS ALTA PRESIÓN

**HIGH PRESSURE  
HYDRAULIC VALVES  
VALVES HYDRAULIQUES  
HAUTE PRESSION**

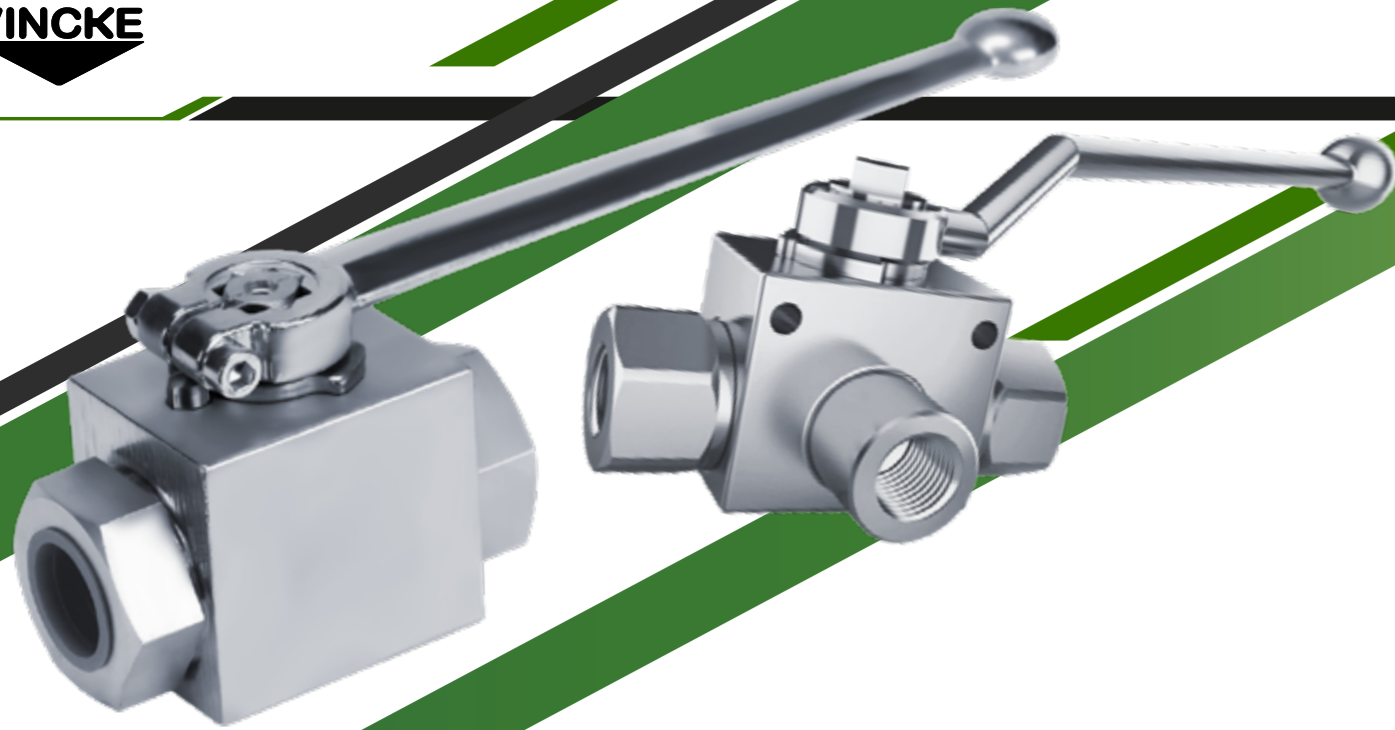

**VÁLVULAS HIDRAULICAS  
ALTA PRESIÓN**  
**HIGH PRESSURE HYDRAULIC VALVES**  
**VALVES HYDRAULIQUES HAUTE PRESSION**

**01** **VÁLVULAS HIDRÁULICAS 2 VÍAS  
ALTA PRESIÓN**  
 2-WAY HIGH PRESSURE HYDRAULIC  
 VALVES  
 VALVES HYDRAULIQUES 2 VOIES  
 HAUTE PRESSION  
**PÁGINA 232**

**02** **VÁLVULAS HIDRÁULICAS 3 VÍAS  
ALTA PRESIÓN**  
 3-WAY VERY HIGH PRESSURE  
 HYDRAULIC VALVES  
 VALVES HYDRAULIQUES 3 VOIES  
 HAUTE PRESSION  
**PÁGINA 233**

**VÁLVULAS HIDRÁULICAS 2 VIAS ALTA PRESIÓN**  
2-WAY HIGH PRESSURE HYDRAULIC VALVES  
VALVES HYDRAULIQUES 2 VOIES HAUTE PRESSION

**2 VIAS SERIE BKH ROSCA BSPP CON TALADROS**

2-WAY SERIES BKH BSPP THREAD WITH HOLES  
2 VOIES SÉRIE BKH FILETAGE BSPP AVEC TROUS



Ref.	Ø	1/16"	Type	500	€
VNKVH2F0402	4	1/8	BKH	500	38,93
VNKVH2F0604	6	1/4	BKH	500	26,18
VNKVH2F1006	10	3/8	BKH	500	28,92
VNKVH2F1308	13	1/2	BKH	500	31,07
VNKVH2F2012	20	3/4	BKH	315	57,06
VNKVH2F2516	25	1"	BKH	315	77,69
VNKVH2F2520	25	1" 1/4	BKH	315	94,28
VNKVH2F2524	25	1" 1/2	BKH	315	131,25

**2 VIAS SERIE MKH ROSCA BSPP PASO TOTAL SIN TALADROS**

2-WAY SERIES MKH BSPP THREAD FULL FLOW WITHOUT HOLES  
2 VOIES SÉRIE MKH FILETAGE BSPP PASSAGE TOTAL SANS TROUS



Ref.	Ø	1/16"	Type	350	€
VNKVH23220T	32	1" 1/4	MKH	350	214,71
VNKVH24024T	40	1" 1/2	MKH	350	266,14
VNKVH25032T	50	2"	MKH	350	329,89

**2 VIAS SERIE BKH ROSCA BSPP CON TALADROS CON BOLA INOXIDABLE**

2-WAY SERIES BKH BSPP THREAD WITH HOLES STAINLESS STEEL BALL  
2 VOIES SÉRIE BKH FILETAGE BSPP AVEC TROUS BOULE INOXYDABLE



Ref.	Ø	1/16"	Type	500	€
VNKVHBX2F0604	6	1/4	BKH	500	163,67
VNKVHBX2F1006	10	3/8	BKH	500	124,31
VNKVHBX2F1308	13	1/2	BKH	500	113,47
VNKVHBX2F2012	20	3/4	BKH	315	110,21
VNKVHBX2F2516	25	1"	BKH	315	130,68
VNKVHBX2F2520	25	1" 1/4	BKH	315	268,61

**VÁLVULAS HIDRÁULICAS 3 VIAS ALTA PRESIÓN**  
3-WAY VERY HIGH PRESSURE HYDRAULIC VALVES  
VALVES HYDRAULIQUES 3 VOIES HAUTE PRESSION

**3 VIAS SERIE BK3 ROSCA BSPP CON TALADROS EN "L"**

3-WAY SERIES BK3 BSPP THREAD WITH HOLES IN "L"  
3 VOIES SÉRIE BK3 FILETAGE BSPP AVEC TROUS EN "L"



Ref.	Ø	1/16"	Type	500	€
VNKVH3F0604	6	1/4	BK3	500	52,00
VNKVH3F1006	10	3/8	BK3	500	51,26
VNKVH3F1308	13	1/2	BK3	315	59,41
VNKVH3F2012	20	3/4	BK3	315	116,79
VNKVH3F2516	25	1"	BK3	315	132,04
VNKVH3F2520	25	1" 1/4	BK3	315	187,07

**3 VIAS SERIE BK3 ROSCA BSPP CON TALADROS EN L MACHO**

3-WAY SERIES BK3 BSPP THREAD WITH HOLES IN L MALE  
3 VOIES SÉRIE BK3 FILETAGE BSPP AVEC TROUS EN L MÂLE



Ref.	Ø	1/16"	Type	500	€
VNKVH3F1006M	10	3/8	BK3	500	51,26
VNKVH3F1308M	13	1/2	BK3	315	59,41

**3 VIAS SERIE BK3 ROSCA BSPP PASO TOTAL SIN TALADROS EN L**

3-WAY SERIES BK3 BSPP THREAD FULL FLOW WITHOUT HOLES IN L  
3 VOIES SÉRIE BK3 FILETAGE BSPP PASSAGE TOTAL SANS TROUS EN L



Ref.	Ø	1/16"	Type	350	€
VNKVH33220T	32	1" 1/4	BK3	350	643,61
VNKVH34024T	40	1" 1/2	BK3	350	882,37
VNKVH35032T	50	2"	BK3	350	1349,50

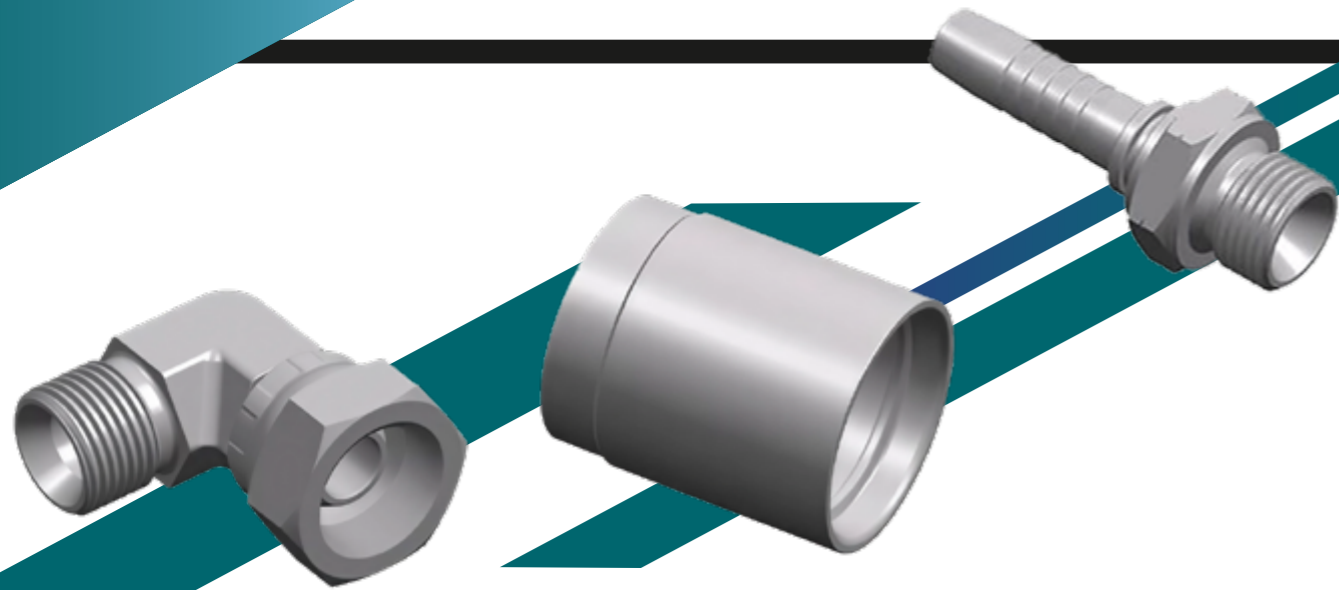

Todas las conexiones inoxidables Vincke son fabricadas en AISI 316L, cumpliendo los estándares de calidad. Racores de prensar, adaptadores BSPP, válvulas de bola, enchufes rápidos, conexiones para flexibles corrugados soldados.

All Vincke connectors are fabricated to AISI316L standards, meeting quality standards. hose fittings, BSPP adaptors, ball valves, quick release couplings, connections for the manufacturing of stainless steel hoses

*Tous les raccords en acier inoxydable Vincke sont fabriqués en AISI 316L, répondant aux normes de qualité les plus élevées. Raccords à sertir, adaptateurs BSP, robinets à tournant sphérique, raccords rapides, accords pour la fabrication de tuyaux en acier inoxydable.*

## RACORES INOXIDABLES AISI 316L VINCKE

VINCKE STAINLESS STEEL  
FITTINGS AISI 316

*RACCORDS EN ACIER INOX AISI  
316L VINCKE*



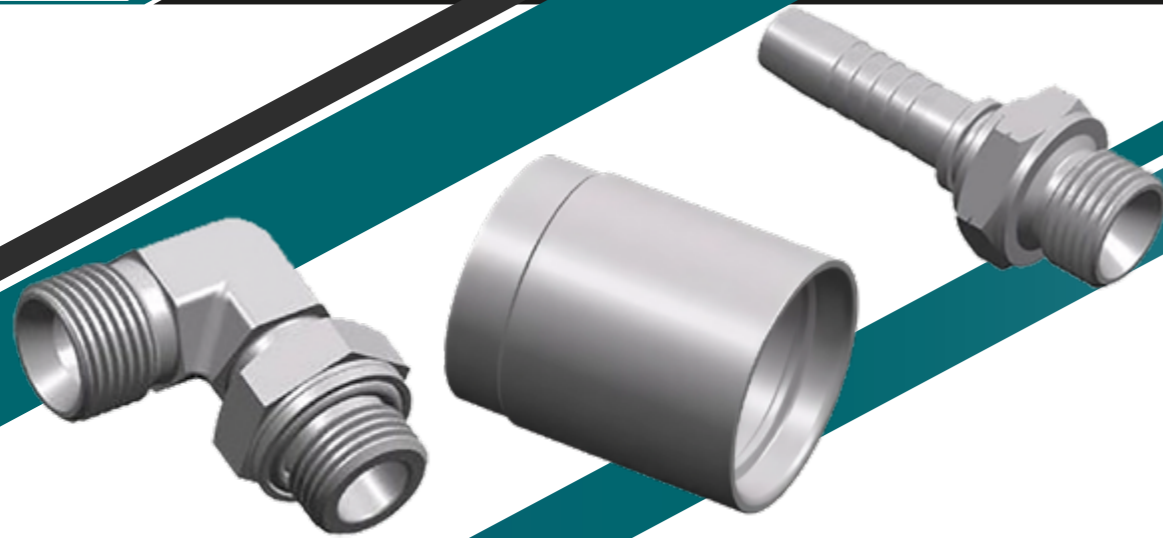

**RACORES INOXIDABLES  
AISI 316L VINCKE**  
VINCKE STAINLESS STEEL  
FITTINGS AISI 316  
*RACCORDS EN ACIER INOX AISI  
316L VINCKE*

**01 CONEXIONES PRENSAR ALTA PRESIÓN  
INOXIDABLE AISI 316L**  
STAINLESS STEEL AISI 316L HIGH PRES.  
CRIMPING FITTINGS  
*CONNECTIQUE À SERTIR HAUTE/  
PRESSION AISI 316L*  
**PÁGINA 238**

**02 ADAPTADORES BSPP INOXIDABLE  
AISI 316L**  
BSPP ADAPTERS STAINLESS STEEL  
AISI 316L  
*ADAPTATEURS BSPP INOX AISI 316L*  
**PÁGINA 245**

**03 RACORES DIN2353 INOXIDABLE  
AISI 316L**  
DIN2353 FITTINGS STAINLESS STEEL  
AISI 316L  
*RACCORDS DIN2353 AISI 316L*  
**PÁGINA 251**

**04 ENCHUFES RÁPIDOS INOXIDABLE  
AISI 316L**  
QUICK RELEASE COUPLINGS STAINLESS  
STEEL AISI 316L  
*COUPLEURS R APIDES EN ACIER INOX  
AISI 316L*  
**PÁGINA 253**

**05 VÁLVULAS HIDRÁULICAS INOXIDABLE  
AISI 316L VINCKE**  
VINCKE HYDRAULIC VALVES STAINLESS  
STEEL AISI 316L  
*VALVES HYDRAULIQUES HAUTE PRESSION  
ACIER INOX  
AISI 316L VINCKE*  
**PÁGINA 254**



**CONEXIONES PRENSAR ALTA PRESIÓN INOXIDABLE AISI 316L**  
**STAINLESS STEEL AISI 316L HIGH PRESSURE CRIMPING FI**  
**CONNECTIQUE À SERTIR HAUTE PRESSION AISI 316L**

**CASQUILLOS AISI 316L**  
**FERRULES**  
**JUPES**



**CASQUILLO 1SN 2SN 2SC 2SNK AISI 316L**  
FERRULE 1SN 2SN 2SC 2SNK AISI 316L  
JUPE 1SN 2SN 2SC 2SNK AISI 316L

Ref.		€
RAIX00550004	1/4	9,58
RAIX00550005	5/16	10,74
RAIX00550006	3/8	11,76
RAIX00550008	1/2	14,32
RAIX00550010	5/8	17,18
RAIX00550012	3/4	24,47
RAIX00550016	1"	38,02
RAIX00550020	1" 1/4	65,07
RAIX00550024	1" 1/2	79,35
RAIX00550032	2"	111,11

**CASQUILLO 4SP 4SS+ 4SH NO PELADO EXT. AISI 316L**  
4SP 4SS+ 4SH FERRULE NOT OUTER SKIVE AISI 316L  
JUPE 4SP 4SS+ 4SH SANS DENUDAGE EXTÉRIEUR AISI 316L



Ref.		€
RAIX004N0010	5/8	20,84
RAIX004N0012	3/4	32,64
RAIX004N0016	1"	40,55

**CASQUILLO AISI 316L R7-R8**  
FERRULE AISI 316L R7-R8  
JUPE AISI 316L R7-R8



Ref.		€
RAIX00070004	1/4	14,02
RAIX00070006	3/8	16,19
RAIX00070008	1/2	20,36

**CASQUILLO PTFE LISO AISI 316L**  
SMOOTH PTFE FERRULE AISI 316L  
JUPE PTFE LISSE AISI 316L



Ref.		€
RAIX00060004	1/4	12,12
RAIX00060005	5/16	14,39
RAIX00060006	3/8	12,90
RAIX00060008	1/2	16,33
RAIX00060012	3/4	23,41
RAIX00060016	1"	38,62



**CASQUILLO PTFE COARRUGADO AISI 316L**  
FERRULE PTFE CONVOLUTED AISI 316L  
JUPE À SERTIR PTFE ONDULÉ

Ref.		€
RAIX0050006	3/8	9,13
RAIX0050008	1/2	10,54
RAIX0050010	5/8	14,37
RAIX0050012	3/4	19,58
RAIX0050016	1"	28,27
RAIX0050020	1" 1/4	42,87
RAIX0050024	1" 1/2	58,04
RAIX0050032	2"	97,32

**RACOR PRENSAR ALTA PRESIÓN AISI 316L**  
**HIGH CRIMPING FITTINGS AISI 316L**  
**CONNECTIQUE À SERTIR HAUTE PRESSION AISI 316L**

**RACORES PRENSAR BSPP AISI 316L**  
**BSPP HOSE FITTINGS AISI 316L**  
**BSPP RACCORD À SERTIR AISI 316L**



**HEMBRA GIRATORIA BSPP CONO 60° O-RING AISI 316L**  
60° BSPP CONE O-RING SWIVEL FEMALE AISI 316L  
FEMELLE TOURNANTE BSPP CÔNE 60° O-RING

Ref.			€
RAIX10110204	1/8	1/4	25,06
RAIX10110404	1/4	1/4	11,84
RAIX10110604	3/8	1/4	18,85
RAIX10110605	3/8	5/16	18,85
RAIX10110606	3/8	3/8	15,33
RAIX10110806	1/2	3/8	20,95
RAIX10110808	1/2	1/2	18,61
RAIX10111208	3/4	1/2	35,99
RAIX10111210	3/4	5/8	46,71
RAIX10111212	3/4	3/4	28,99
RAIX10111612	1"	3/4	50,93
RAIX10111616	1"	1"	50,58
RAIX10112016	1" 1/4	1"	130,69
RAIX10112020	1" 1/4	1" 1/4	90,23
RAIX10112424	1" 1/2	1" 1/2	116,88
RAIX10113232	2"	2"	187,30

**MACHO FIJO BSPP BSPP AISI 316L**

BSPP STUD MALE AISI 316L  
 MÂLE FIXE BSPP AISI 316L



Ref.			€
RAIX10130404	1/4	1/4	13,67
RAIX10130604	3/8	1/4	27,34
RAIX10130605	3/8	5/16	23,24
RAIX10130606	3/8	3/8	16,61
RAIX10130806	1/2	3/8	23,63
RAIX10130808	1/2	1/2	22,15
RAIX10131212	3/4	3/4	33,22
RAIX10131616	1"	1"	59,64
RAIX10132020	1" 1/4	1" 1/4	152,38
RAIX10132424	1" 1/2	1" 1/2	177,60
RAIX10133232	2"	2"	291,81

**HEMBRA GIRATORIA 90° O-RING BSPP AISI 316L**

90° BSPP SWIVEL FEMALE O-RING AISI 316L  
 FEMELLE TOURNANTE 90° O-RING BSPP AISI 316L



Ref.			€
RAIX10150404	1/4	1/4	25,37
RAIX10150604	3/8	1/4	36,23
RAIX10150606	3/8	3/8	27,83
RAIX10150806	1/2	3/8	44,29
RAIX10150808	1/2	1/2	36,43
RAIX10151208	3/4	1/2	60,76
RAIX10151212	3/4	3/4	60,76
RAIX10151612	1"	3/4	91,00
RAIX10151616	1"	1"	90,23
RAIX10152020	1" 1/4	1" 1/4	182,16
RAIX10152424	1" 1/2	1" 1/2	299,15
RAIX10153232	2"	2"	464,00

**HEMBRA GIRATORIA 45° O-RING BSPP AISI 316L**

BSPP 45° SWIVEL FEMALE O-RING AISI 316L  
 FEMELLE TOURNANTE 45° O-RING BSPP AISI 316L



Ref.			€
RAIX10160404	1/4	1/4	25,37
RAIX10160604	3/8	1/4	36,23
RAIX10160606	3/8	3/8	27,83
RAIX10160808	1/2	1/2	36,43
RAIX10161212	3/4	3/4	60,76
RAIX10161612	1"	3/4	91,00
RAIX10161616	1"	1"	90,23



**HEMBRA GIRATORIA SAE JIC AISI 316L**

SAE JIC SWIVEL FEMALE AISI 316L  
 FEMELLE TOURNANTE SAE JIC AISI 316L

Ref.			€
RAIX10410404	7/16	1/4	14,49
RAIX10410504	1/2	1/4	16,41
RAIX10410604	9/16	1/4	17,52
RAIX10410605	9/16	5/16	17,52
RAIX10410606	9/16	3/8	17,52
RAIX10410806	3/4	3/8	21,60
RAIX10410808	3/4	1/2	21,19
RAIX10411006	7/8	3/8	24,50

**MACHO FIJO SAE JIC AISI 316L**

SAE JIC STUD MALE AISI 316L  
 MÂLE FIXE SAE JIC AISI 316L



Ref.			€
RAIX10430404	7/16	1/4	21,11
RAIX10430504	1/2	1/4	20,12
RAIX10430604	9/16	1/4	27,27
RAIX10430606	9/16	3/8	27,27
RAIX10430806	3/4	3/8	21,05
RAIX10430808	3/4	1/2	25,87
RAIX10431006	7/8	3/8	23,54
RAIX10431008	7/8	1/2	23,54
RAIX10431210	1" 1/16	5/8	38,05
RAIX10431212	1 1/16	3/4	38,05
RAIX10431616	1" 5/16	1"	66,86

**HEMBRA GIRATORIA 90° SAE JIC AISI 316L**

90° SAE JIC SWIVEL FEMALE AISI 316L  
 FEMELLE TOURNANTE 90° SAE JIC AISI 316L



Ref.			€
RAIX10450404	7/16	1/4	27,06
RAIX10450604	9/16	1/4	32,72
RAIX10450605	9/16	5/16	32,72
RAIX10450606	9/16	3/8	32,72
RAIX10450806	3/4	3/8	42,10
RAIX10450808	3/4	1/2	35,52

Ref.			€
RAIX10451008	7/8	1/2	42,49
RAIX10451010	7/8	5/8	42,49
RAIX10451210	1" 1/16	5/8	63,68
RAIX10451212	1" 1/16	3/4	63,68
RAIX10451612	3/4	1" 5/16	63,68
RAIX10451616	1" 5/16	1"	97,88

**HEMBRA GIRATORIA 45° SAE JIC AISI 316L**

45° SAE JIC SWIVEL FEMALE AISI 316L  
 FEMELLE TOURNANTE 45° SAE JIC AISI 316L



Ref.			€
RAIX10460404	7/16	1/4	27,06
RAIX10460606	9/16	3/8	32,72
RAIX10460806	3/4	3/8	42,10
RAIX10460808	3/4	1/2	35,52
RAIX10461008	7/8	1/2	47,95
RAIX10461212	1" 1/16	3/4	63,68
RAIX10461616	1" 5/16	1"	97,88
RAIX10460605	9/16	5/16	32,44

**RACOR PRENSAR SAE JIC AISI 316L**

SAE JIC Ø FITTING AISI 316L  
 RACCORD À SERTIR SAE JIC AISI 316L

Ref.			€
RAIX10411008	7/8	1/2	24,50
RAIX10411010	7/8	5/8	24,50
RAIX10411210	1" 1/16	5/8	31,44
RAIX10411212	1" 1/16	3/4	31,44
RAIX10411612	1" 5/16	3/4	59,09
RAIX10411616	1" 5/16	1"	53,69
RAIX10412016	1" 5/8	1"	112,82

**RACOR PRENSAR MÉTRICO AISI 316L**  
METR. Ø FITTING AISI 316L  
RACCORD À SERTIR MÉTRIQUE AISI 316L

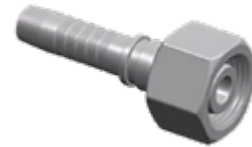

**HEMBRA GIRATORIA MÉTRICA SERIE LIGERA AISI 316L**

METR. SWIVEL FEMALE LIGHT SERIES AISI 316L  
FEMELLE TOURNANTE MÉTRIQUE SÉRIE LÉGÈRE AISI 316L

Ref.	Ø			€
RAIX10811404	8L	14x150	1/4	12,77
RAIX10811604	10L	16x150	1/4	16,15
RAIX10811605	10L	16x150	5/16	16,22
RAIX10811804	12L	18x150	1/4	24,90
RAIX10811805	12L	18x150	5/16	19,80
RAIX10811806	12L	18x150	3/8	15,55
RAIX10812208	15L	22x150	1/2	23,61
RAIX10812610	18L	26x150	5/8	32,23
RAIX10813012	22L	30x200	3/4	39,81
RAIX10813616	28L	36x200	1"	62,68
RAIX10814520	35L	45x200	1"1/4	140,32

**MACHO FIJO MÉTRICO SERIE LIGERA AISI 316L**

METR. STUD MALE LIGHT SERIES AISI 316L  
MÂLE FIXE MÉTRIQUE SÉRIE LÉGÈRE AISI 316L



Ref.	Ø			€
RAIX10631404	8S/L	14x150	1/4	18,13
RAIX10631604	10S/L	16x150	1/4	22,48
RAIX10631806	12S/L	18x150	3/8	14,03
RAIX10632208	15S/L	22x150	1/2	22,72
RAIX10632610	18S/L	26x150	5/8	31,15
RAIX10633012	22S/L	30x200	3/4	41,25
RAIX10633616	28S/L	36x200	1"	64,66

**HEMBRA GIRATORIA 90° MÉTRICA SERIE LIGERA AISI 316L**

90° METR. SWIVEL FEMALE LIGHT SERIES AISI 316L  
FEMELLE TOURNANTE 90° MÉTRIQUE SÉRIE LÉGÈRE



Ref.	Ø			€
RAIX10851404	8L	14x150	1/4	31,58
RAIX10851604	10L	16x150	1/4	31,58
RAIX10851605	10L	16x150	5/16	35,92
RAIX10851805	12L	18x150	5/16	43,79
RAIX10851806	12L	18x150	3/8	32,13
RAIX10852208	15L	22x150	1/2	39,79
RAIX10852610	18L	26x150	5/8	59,87
RAIX10853012	22L	30x200	3/4	72,18
RAIX10853616	28L	36x200	1"	106,15

**HEMBRA GIRATORIA 45° MÉTRICA SERIE LIGERA AISI 316L**

45° METR. SWIVEL FEMALE LIGHT SERIES  
FEMELLE TOURNANTE 45° MÉTRIQUE SÉRIE LÉGÈRE



Ref.	Ø			€
RAIX10861404	8L	14x150	1/4	26,94
RAIX10861604	10L	16x150	1/4	34,58
RAIX10861806	12L	18x150	3/8	32,13
RAIX10862208	15L	22x150	1/2	39,79
RAIX10862610	18L	26x150	5/8	59,87
RAIX10863012	22L	30x200	3/4	72,18
RAIX10863616	28L	36x200	1"	106,15

**HEMBRA GIRATORIA MÉTRICA SERIE PESADA AISI 316L**

HEAVY SERIES METR. FITTING AISI 316L  
RACCORD À SERTIR SÉRIE LOURDE AISI 316L



Ref.	Ø			€
RAIX10911604	8S	16x150	1/4	17,83
RAIX10911804	10S	18x150	1/4	17,52
RAIX10912006	12S	20x150	3/8	19,85
RAIX10912206	14S	22x150	3/8	24,91
RAIX10912408	16S	24x150	1/2	22,42
RAIX10913010	20S	30x200	5/8	32,42
RAIX10913012	20S	30x200	3/4	47,50
RAIX10913612	25S	36x200	3/4	60,15
RAIX10914216	30S	42x200	1"	79,84
RAIX10915220	38S	52x200	1"1/4	127,56

**MACHO FIJO MÉTRICO SERIE PESADA AISI 316L**

METR. STUD MALE HEAVY SERIES AISI 316L  
MÂLE FIXE MÉTRIQUE SÉRIE LOURDE AISI 316L



Ref.	Ø			€
RAIX10731604	8S	16x150	1/4	22,08
RAIX10731804	10S	18x150	1/4	30,86
RAIX10732206	14S	22x150	3/8	32,73
RAIX10732408	16S	24x150	1/2	23,84
RAIX10733010	20S	30x200	5/8	41,76
RAIX10733612	25S	36x200	3/4	57,22
RAIX10734216	30S	42x200	1"	91,32

**ADAPTADORES BSPP INOXIDABLE AISI 316L**  
**BSPP ADAPTERS STAINLESS STEEL AISI 316L**  
**ADAPTATEURS BSPP INOX AISI 316L**

**RACOR SOLDABLE AISI 316L**  
**WELDING FITTING AISI 316L**  
**RACCORD À SOUDER AISI 316L**



**HEMBRA GIRATORIA 90° MÉTRICA SERIE PESADA AISI 316L**

90° METR. SWIVEL FEMALE HEAVY SERIES AISI 316L  
FEMELLE TOURNANTE 90° MÉTRIQUE S.LOURDE AISI 316L

Ref.	Ø	11111	11111	€
RAIX10951604	8S	16x150	1/4	34,03
RAIX10951804	10S	18x150	1/4	33,88
RAIX10952005	12S	20x150	5/16	36,18
RAIX10952006	12S	20x150	3/8	36,18
RAIX10952206	14S	22x150	3/8	49,11
RAIX10952408	16S	24x150	1/2	41,21
RAIX10953010	20S	30x200	5/8	73,21
RAIX10953612	25S	36x200	3/4	103,01
RAIX10954216	30S	42x200	1"	144,29



**HEMBRA GIRATORIA 45° MÉTRICA SERIE PESADA AISI 316L**

45° METR. SWIVEL FEMALE HEAVY SERIES AISI 316L  
FEMELLE TOURNANTE 45° MÉTRIQUE S. LOURDE AISI 316L

Ref.	Ø	11111	11111	€
RAIX10961604	8S	16x150	1/4	34,03
RAIX10961804	10S	18x150	1/4	33,88
RAIX10962005	12S	20x150	5/16	44,29
RAIX10962206	14S	22x150	3/8	49,11
RAIX10962408	16S	24x150	1/2	41,21
RAIX10963010	20S	30x200	5/8	73,21
RAIX10963612	25S	36x200	3/4	103,01
RAIX10964216	30S	42x200	1"	144,29



**ESFÉRICO BSPP - MÉTRICO AISI 316L**

BSPP METRIC BANJO AISI 316L  
BANJO BSPP MÉTRIQUE AISI 316L

Ref.	11111	11111	€
RAIX10340404	1/4	1/4	64,56
RAIX10340606	3/8	3/8	106,87
RAIX10340808	1/2	1/2	112,35

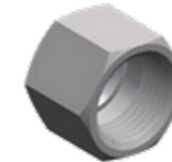

**TUERCA BSPP AISI 316L**

BSPP NUT AISI 316L  
ÉCROU BSPP AISI 316L

Ref.	11111	€
RAIX60000004	1/4	4,87
RAIX60000006	3/8	6,49
RAIX60000008	1/2	7,03
RAIX60000012	3/4	8,65
RAIX60000016	1"	15,14
RAIX60000020	1"1/4	29,20
RAIX60000024	1"1/2	41,10
RAIX60000032	2"	59,49



**CONO BSPP SOLDABLE AISI 316L**

BSPP WELDING MALE AISI 316L  
CÔNE BSPP À SOUDER AISI 316L

Ref.	11111	€
RAIX60010004	1/4	8,03
RAIX60010006	3/8	9,04
RAIX60010008	1/2	10,08
RAIX60010012	3/4	14,85
RAIX60010016	1"	18,05
RAIX60010020	1"1/4	30,15
RAIX60010024	1"1/2	39,32
RAIX60010032	2"	58,94

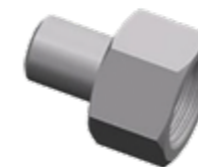

**HEMBRA GIRATORIA ASIENTO PLANO SOLDAR AISI 316L**

WELDING FEMALE BSPP FLAT SEAT AISI 316L  
FEMELLE TOURNANTE BSPP FOND PLAT SOUDER AISI 316L

Ref.	11111	€
RAIX60650004	1/4	12,94
RAIX60650006	3/8	15,01
RAIX60650008	1/2	17,58
RAIX60650012	3/4	20,93
RAIX60650016	1"	32,78
RAIX60650020	1"1/4	63,59
RAIX60650024	1"1/2	85,39
RAIX60650032	2"	134,55

**ADAPTADORES BSPP RECTOS AISI 316L**  
BSPP STRAIGHT ADAPTER AISI 316L  
ADAPTATEURS DROITS BSPP AISI 316L

**MANGUITO SOLDABLE ROSCA INTERIOR AISI 316L**

WELDING ADAPTER INNER THREAD AISI 316L  
MANCHON À SOUDER FILETAGE INTÉRIEUR AISI 316L



Ref.		€
RAIX60020004	1/4	18,82
RAIX60020006	3/8	24,39
RAIX60020008	1/2	33,92
RAIX60020012	3/4	51,13
RAIX60020016	1"	70,72

**MACHO BSPP CONO 60° SOLDABLE CON PERNO AISI 316L**

60° BSPP MALE WELDING CONE AISI 316L  
MÂLE BSPP CONE 60° À SOUDER AVEC BOULON AISI 316L



Ref.		€
RAIX60040004	1/4	13,43
RAIX60040006	3/8	13,53
RAIX60040008	1/2	15,27
RAIX60040012	3/4	27,63
RAIX60040016	1"	52,80
RAIX60040020	1"1/4	87,99
RAIX60040024	1"1/2	96,82
RAIX60040032	2"	161,46

**MACHO NPT CONO 60° SOLDABLE CON PERNO AISI 316L**

60° NPT MALE WELDING CONE AISI 316L  
MÂLE NPT CONE 60° À SOUDER AVEC BOULON AISI 316L



Ref.		€
RAIX60060004	1/4	13,46
RAIX60060006	3/8	14,08
RAIX60060008	1/2	15,53
RAIX60060012	3/4	27,95
RAIX60060016	1"	53,82

**CODO SOLDAR AISI 316L**

WELDING ELBOW 90° AISI 316L  
COUDE À SOUDER 90° AISI 316L



Ref.		€
RAIX60070004	1/4	32,29
RAIX60070006	3/8	37,67
RAIX60070008	1/2	47,09
RAIX60070012	3/4	67,28
RAIX60070016	1	80,73
RAIX60070020	1"1/4	134,55
RAIX60070024	1"1/2	174,92
RAIX60070032	2	191,06

**UNIÓN MACHO-MACHO BSPP AISI 316L**

BSPP MALE-MALE UNION AISI 316L  
UNION MÂLE-MÂLE BSPP AISI 316L



Ref.			€
RAIX60180204	1/8	1/4	10,96
RAIX60180404	1/4	1/4	10,16
RAIX60180406	3/8	1/4	12,92
RAIX60180408	1/4	1/2	19,27
RAIX60180606	3/8	3/8	11,93
RAIX60180608	3/8	1/2	17,73
RAIX60180808	1/2	1/2	15,65
RAIX60180812	1/2	3/4	26,23
RAIX60181212	3/4	3/4	24,02
RAIX60181216	3/4	1"	49,19
RAIX60181616	1"	1"	45,39
RAIX60181620	1"	1"1/4	68,28
RAIX60182020	1"1/4	1"1/4	62,99
RAIX60182024	1"1/4	1"1/2	97,26
RAIX60182424	1"1/2	1"1/2	78,12
RAIX60182432	1"1/2	2"	153,06
RAIX60183232	2"	2"	138,76

**SUPLEMENTO MACHO-HEMBRA FIJA BSPP AISI 316L**

BSPP ADAPT. MALE FEMALE AISI 316L  
SUPPLÉMENT MÂLE-FEMELLE FIXE BSPP AISI 316L



Ref.			€
RAIX60170404	1/4	1/4	17,49
RAIX60170406	1/4	3/8	22,47
RAIX60170604	3/8	1/4	23,98
RAIX60170606	3/8	3/8	18,28
RAIX60170608	3/8	1/2	30,18
RAIX60170806	1/2	3/8	26,97
RAIX60170808	1/2	1/2	22,22
RAIX60171212	3/4	3/4	33,87
RAIX60171216	3/4	1"	52,32
RAIX60171616	1"	1"	48,86

**TAPONES REDUCTOR MACHO 60° -HEMBRA FIJA BSPP AISI 316L**

60° MALE REDUCER PLUG BSPP STRAIGHT FEMALE AISI 316L  
BOUCHON RÉDUCTEUR MÂLE 60° FEMELLE FIXE BSPP AISI 316L



Ref.			€
RAIX60160604	3/8	1/4	19,78
RAIX60160806	1/2	3/8	21,45
RAIX60161208	3/4	1/2	24,99
RAIX60161612	1"	3/4	39,54
RAIX60162016	1"1/4	1"	68,56

**MACHO-HEMBRA GIRATORIA 60° BSPP AISI 316L**

BSPP MALE- 60° SWIVEL FEMALE  
 MÂLE-FEMELLE TOURNANTE 60° BSPP



Ref.			€
RAIX60200404	1/4	1/4	28,20
RAIX60200606	3/8	3/8	36,01
RAIX60200808	1/2	1/2	44,17
RAIX60201212	3/4	3/4	70,67
RAIX60201616	1"	1"	105,43

**PASATABIQUES CON TUERCA BSPP AISI 316L**

BULKHEAD WITH NUT BSPP AISI 316L  
 PASSE CLOISON AVEC ÉCROU BSPP AISI 316L

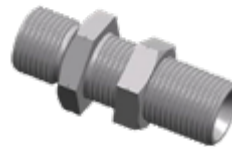

Ref.		€
RAIX60230004	1/4	28,38
RAIX60230006	3/8	32,44
RAIX60230008	1/2	38,23

**TORNILLO ORIENTABLE SIMPLE BSPP AISI 316L**

BSPP SINGLE ADJUSTABLE BOLT AISI 316L  
 VIS ORIENTABLE SIMPLE BSPP AISI 316L



Ref.		€
RAIX60250004	1/4	21,20
RAIX60250006	3/8	31,05
RAIX60250008	1/2	39,39

**TAPONES MACHO BSPP CIERRE CONO 60° AISI 316L**

BSPP MALE PLUG 60° CONE AISI 316L  
 BOUCHON MÂLE BSPP FERMETURE CÔNE 60° AISI 316L



Ref.		€
RAIX60520004	1/4	9,26
RAIX60520006	3/8	10,60
RAIX60520008	1/2	14,54
RAIX60520012	3/4	18,02
RAIX60520016	1"	30,38

**TAPONES HEMBRA BSPP CIERRE CONO 60° AISI 316L**

BSPP FEMALE PLUG 60° CONE AISI 316L  
 BOUCHON FEMELLE BSPP FERMETURE CÔNE 60° AISI 316L

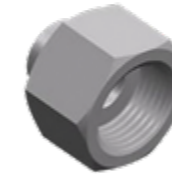

Ref.		€
RAIX60530004	1/4	13,14
RAIX60530006	3/8	15,58
RAIX60530008	1/2	20,01
RAIX60530012	3/4	26,56
RAIX60530016	1"	43,47

**TAPONES MACHO BSPP CIERRE ALLEN AISI 316L CON JUNTA FKM**

BSPP MALE HOLLOW HEX PLUG AISI 316L WITH CAPTIVE FKM SEAL  
 BOUCHON MÂLE BSPP FERMETURE ALLEN AISI 316L AVEC JOINT FKM



Ref.		€
RAIX60140004	1/4	8,12
RAIX60140006	3/8	9,27
RAIX60140008	1/2	13,67
RAIX60140012	3/4	15,64
RAIX60140016	1"	41,13

**ADAPTADORES BSPP CODOS AISI 316L**  
 BSPP ADAPTER FORGING AISI 316L  
 ADAPTATEURS BSPP COUDES AISI 316L

**CODO 90° MACHO HEMBRA BSPP AISI 316L**

90° BSPP MALE-FEMALE ELBOW  
 COUDE 90° MÂLE FEMELLE BSPP AISI 316L



Ref.			€
RAIX60440404	1/4	1/4	71,06
RAIX60440606	3/8	3/8	48,23
RAIX60440808	1/2	1/2	58,77
RAIX60441212	3/4	3/4	86,13
RAIX60441616	1"	1"	118,18

**CODO 90° MACHO ORIENTABLE MACHO FIJO BSPP AISI 316L**

90° ELBOW BSPP ADJUST. MALE STUD MALE AISI 316L  
 COUDE 90° MÂLE ORIENTABLE MÂLE FIXE BSPP AISI 316L



Ref.		€
RAIX60370404	1/4	41,94
RAIX60370606	3/8	54,11
RAIX60370808	1/2	90,14
RAIX60371212	3/4	115,51
RAIX60371616	1"	146,61

**ADAPTADORES BSPP T AISI 316L**  
 T BSPP ADAPTER AISI 316L  
 ADAPTATEURS BSPP T AISI 316L



**T MACHO FIJO MACHO FIJO HEMBRA GIRATORIA BSPP AISI 316L**  
 T BSPP MALE MALE SWIVEL FEMALE AISI 316L  
 T MÂLE FIXE MÂLE FIXE FEMELLE TOURNANTE BSPP AISI 316L

Ref.		€
RAIX60460404	1/4	39,90
RAIX60460606	3/8	47,49
RAIX60460808	1/2	56,23



**T MACHO FIJO HEMBRA GIRATORIA MACHO FIJO BSPP**  
 T BSPP MALE SWIVEL FEMALE MALE AISI 316L  
 T MÂLE FIXE FEMELLE TOURNANTE MÂLE FIXE BSPP AISI 316L

Ref.		€
RAIX60470404	1/4	39,90
RAIX60470606	3/8	47,49
RAIX60470808	1/2	56,23



**ARANDELA METAL ACERO INOX. FKM BSPP**  
 BSPP FKM STEEL INOX. SEAL  
 BAGUE FKM ACIER INOX. BSPP

Ref.		€
RAIX60480004	1/4	1,20
RAIX60480006	3/8	1,45
RAIX60480008	1/2	2,57
RAIX60480012	3/4	3,04
RAIX60480016	1"	5,39
RAIX60480020	1"1/4	12,63
RAIX60480024	1"1/2	13,61
RAIX60480032	2"	16,21

**RACORES DIN2353 INOXIDABLE AISI 316L**  
 DIN2353 FITTINGS STAINLESS STEEL AISI 316L  
 RACCORDS DIN2353 AISI 316L

**RACOR RECTO AISI 316L**  
 BSPP HREAD STRAIGHT FITTING AISI 316L  
 RACCORD DROIT AISI 316L

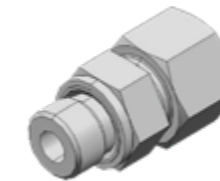

**RACOR RECTO AISI 316L BSPP JUNTA FKM**  
 BSPP HREAD WITH FKM SEAL STRAIGHT FITTING AISI 316L  
 RACCORD DROIT AISI 316L BSPP JOINT FKM

Ref.	Ø		€
TNI040021	6L	1/8	14,38
TNI040047	6L	1/4	17,75
TNI040022	8L	1/4	18,38
TNI040024	8L	3/8	25,41
TNI040048	8L	1/8	23,03
TNI040025	10L	1/4	20,52
TNI040026	10L	3/8	23,13
TNI040051	10L	1/2	28,51
TNI040027	12L	3/8	21,74
TNI040028	12L	1/4	22,21
TNI040029	12L	1/2	26,91

Ref.	Ø		€
TNI040030	15L	1/2	29,50
TNI040052	15L	3/8	30,70
TNI040031	18L	1/2	35,19
TNI040032	22L	3/4	40,31
TNI040033	28L	1	56,93
TNI040038	10S	3/8	27,50
TNI040039	12S	3/8	29,82
TNI040042	16S	1/2	37,14
TNI040043	20S	3/4	48,23
TNI040044	25S	1	91,92

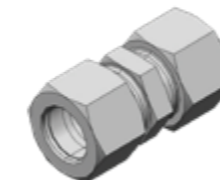

**RACOR UNIÓN TUBO-TUBO AISI 316L**  
 STRAIGHT UNION FIT AISI 316L  
 RACCORD UNION DROIT AISI 316L

Ref.	Ø	€
TNI110004	6L	19,63
TNI110005	8L	22,53
TNI110006	10L	24,37
TNI110007	12L	25,80
TNI110008	15L	37,31
TNI110009	18L	43,47
TNI110010	22L	55,89
TNI110011	28L	79,70

Ref.	Ø	€
TNI110014	6S	22,77
TNI110015	8S	25,75
TNI110016	10S	30,58
TNI110017	12S	35,78
TNI110018	14S	50,72
TNI110019	16S	47,14
TNI110020	20S	63,14
TNI110021	25S	129,24

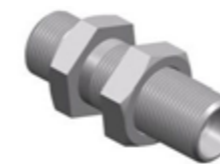

**RACOR UNIÓN PASATABIQUE AISI 316L**  
 BULKHEAD UNION FIT. T102-6L AISI 316L  
 RACCORD UNION PASSE CLOISON T-102-6L AISI 316L

Ref.	Ø	€
TNI150001	6L	29,50
TNI150002	8L	34,16
TNI150003	10L	44,51
TNI150004	12L	50,72
TNI150005	15L	66,24

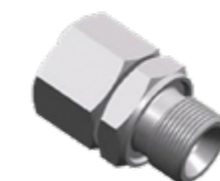

**RACOR HEMBRA GIR. DKO MACHO BSPP C/ JUNTA FKM AISI 316L**  
 SWIVEL DKO FEMALE FITTING BSPP MALE WITH FKM SEAL  
 RACCORD FEMELLE TOURN.DKO MÂLE BSPP A/JOINT FKM AISI 316L

Ref.	Ø		€
TNI330003	10L	1/4	32,09
TNI330004	12L	3/8	33,12
TNI330005	15L	1/2	40,11

**RACOR CODO AISI 316L**  
ELBOW FITTINGS AISI 316L  
RACCORDS COUDE AISI 316L

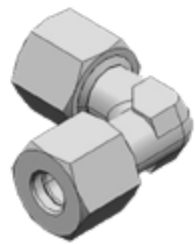

**RACOR UNIÓN CODO AISI 216L**  
ELBOW UNION FITTINGS AISI 316L  
RACCOR UNION COUDE AISI 316

Ref.	Ø	€
TNI120004	6L	29,98
TNI120005	8L	34,57
TNI120006	10L	36,91
TNI120007	12L	40,01
TNI120008	15L	51,98
TNI120009	18L	69,81

Ref.	Ø	€
TNI120010	22L	115,14
TNI120016	10S	37,26
TNI120017	12S	41,40
TNI120019	16S	66,24
TNI120020	20S	89,01
TNI120021	25S	160,43

**RACOR CODO ORIENTABLE AISI 316L**  
ROTARY ELBOW AISI 316L  
COUDE ORIENTABLE AISI 316L



Ref.	Ø	€
TNI280001	6L	35,19
TNI280002	8L	37,52
TNI280003	10L	38,81
TNI280004	12L	45,75
TNI280005	15L	64,69
TNI280006	18L	87,98

Ref.	Ø	€
TNI280007	22L	108,68
TNI280013	10S	53,04
TNI280014	12S	68,57
TNI280016	16S	86,68
TNI280017	20S	125,49

**UNIÓN EN "T" AISI 316L**  
T UNION FITTINGS  
UNION EN "T" AISI 316L

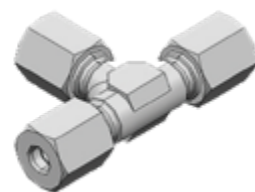

**RACOR UNIÓN EN "T" 100**  
T 100 UNION FIT.  
RACCOR UNION T 100

Ref.	Ø	€
TNI130004	6L	37,26
TNI130005	8L	40,37
TNI130006	10L	46,58
TNI130007	12L	50,72
TNI130008	15L	70,38
TNI130009	18L	84,87
TNI130010	22L	113,85
TNI130017	10S	52,79
TNI130018	12S	65,21
TNI130019	16S	92,12

**ENCHUFES RÁPIDOS INOXIDABLE AISI 316L VINCKE**  
VICNKE QUICK RELEASE COUPLINGS STAINLESS STEEL AISI 316L  
COUPLEURS RAPIDES EN ACIER INOX AISI 316L VINCKE



**SERIE FL INOXIDABLE AISI 316L ISO 16028 ROSCA BSPP**  
FL SERIES ISO 16028 AISI 316L BSPP THREAD  
SÉRIE FL INOX AISI 316L ISO 16028 FILETAGE BSPP

Ref.	Ø	Type	€
STU0704F	1/4	FL7 F	314,12
STU0704M	1/4	FL7 M	213,44
STU0706F	3/8	FL9 F	380,83
STU0706M	3/8	FL9 M	239,96
STU0708F	1/2	FL9 F	384,78
STU0708M	1/2	FL9 M	243,95
STU0708F13	1/2	FL13 F	413,18
STU0708M13	1/2	FL13 M	251,60
STU0712F	3/4	FL13 F	485,56
STU0712M	3/4	FL13 M	291,39

Ref.	Ø	Type	€
STU0712F15	3/4	FL15 F	567,48
STU0712M15	3/4	FL15 M	323,85
STU0716F	1"	FL17 F	746,50
STU0716M	1"	FL17 M	333,41
STU0720F	1"1/4	FL21 F	1259,33
STU0720M	1"1/4	FL21 M	607,77
STU0724F	1"1/2	FL27 F	1962,17
STU0724M	1"1/2	FL27 M	1308,17
STU0732F	2"	FL45 F	8252,57
STU0732M	2"	FL45 M	5941,86



**SERIE VSBX ISO 7241/B ROSCA BSPP**  
VSBX ISO 7241/B SERIES THREAD BSPP AISI 316L  
SÉRIE VSBX ISO 7241/B FILETAGE BSPP

Ref.	Ø	Type	€
VNKEN10I04F	1/4	VSBX 14 F	45,93
VNKEN10I04M	1/4	VSBX 14 M	14,29
VNKEN10I06F	3/8	VSBX 38 F	72,02
VNKEN10I06M	3/8	VSBX 38 M	23,26
VNKEN10I08F	1/2	VSBX 12 F	124,35
VNKEN10I08M	1/2	VSBX 12 M	30,53
VNKEN10I12F	3/4	VSBX 34 F	210,16
VNKEN10I12M	3/4	VSBX 34 M	67,44
VNKEN10I16F	1"	VSBX 100 F	309,60
VNKEN10I16M	1"	VSBX 100 M	109,54



**SERIE VSAX ISO 7241/A ROSCA BSPP VINCKE**  
VINCKE VSAX ISO 7241/A SERIES THREAD BSPP AISI 316L  
SÉRIE VSAX ISO 7241/A FILETAGE BSPP VINCKE

Ref.	Ø	Type	€
VNKEN09I04F	1/4	VSAX 14 F	45,93
VNKEN09I04M	1/4	VSAX 14 M	14,29
VNKEN09I06F	3/8	VSAX 38 F	72,02
VNKEN09I06M	3/8	VSAX 38 M	23,26
VNKEN09I08F	1/2	VSAX 12 F	124,35
VNKEN09I08M	1/2	VSAX 12 M	30,53
VNKEN09I12F	3/4	VSAX 34 F	210,16
VNKEN09I12M	3/4	VSAX 34 M	67,44
VNKEN09I16F	1"	VSAX 100 F	309,60
VNKEN09I16M	1"	VSAX 100 M	109,54

**VÁLVULAS HIDRÁULICAS INOXIDABLE AISI 316L VINCKE**  
VINCKE HYDRAULIC VALVES STAINLESS STEEL AISI 316L  
VALVES HYDRAULIQUES HAUTE PRESSION ACIER INOX AISI 316L VINCKE

**2 VIAS SERIE BKH ROSCA BSPP SIN TALADROS INOXIDABLE**

2-WAY SERIES BKH BSPP THREAD WITHOUT HOLES AISI 316L  
2 VOIES SÉRIE BKH FILETAGE BSPP SANS TROUS ACIER INOX AISI 316L



Ref.	Ø	1/16"	Type	1/2"	€
VNKVH2X0604	6L	1/4	BKH	500	201,77
VNKVH2X1006	10L	3/8	BKH	500	220,14
VNKVH2X1308	13L	1/2	BKH	500	238,40
VNKVH2X2012	20L	3/4	BKH	315	415,91
VNKVH2X2516	25L	1"	BKH	315	507,86

**VÁLVULAS ANTIRRETORNO INOXIDABLE AISI 316L**

CHECK VALVES STAINLESS STEEL AISI 316L  
VALVES ANTI-RETOUR ACIER INOX AISI 316L



Ref.	1/16"	1/8"	Type	1/2"	€
VNKL05I0001	1/4	24	K-SCLV-I-14	350	38,71
VNKL05I0002	3/8	46	K-SCLV-I-38	350	46,58
VNKL05I0003	1/2	90	K-SCLV-I-12	350	57,44

**REGULADORES CAUDAL**  
FLOW CONTROL  
RÉGULATEURS DÉBIT

**REGULADORES DE CAUDAL POMO UNIDIRECCIONAL AISI 316L**

UNIDIRECTIONAL FLOW CONTROL VALVES WITH JOYSTICK AISI 316L  
RÉGULATEUR DE DÉBIT VOLANT UNIDIRECTIONNEL AISI 316L



Ref.	1/16"	1/8"	Type	1/2"	€
VNKL14I0001	1/4	40	DRVI-14	350	195,73
VNKL14I0002	3/8	60	DRVI-3/8	350	248,05
VNKL14I0003	1/2	80	DRVI-12	350	363,29

**REGULADORES DE CAUDAL POMO BIDIRECCIONAL AISI 316L**

BIDIRECTIONAL FLOW CONTROL VALVES WITH JOYSTICK AISI 316L  
RÉGULATEUR DE DÉBIT VOLANT BIDIRECTIONNEL AISI 316L



Ref.	1/16"	1/8"	Type	1/2"	€
VNKL14I0008	1/4	40	DVI-12	350	187,34
VNKL14I0009	3/8	60	DVI-38	350	209,07
VNKL14I0010	1/2	80	DVI-12	350	332,24

**SOLDABLES PARA MANGUERA INOXIDABLE**  
WELDING FOR STAINLESS STEEL HOSES  
BRIDES A SOUDER INOX

**CASQUILLO AISI 316L**

FERRULES AISI 316L  
JUPES AISI 316L



Ref.	1/16"	1/8"	€
RAIX00SS0004	1/4	12X15 X 20	1,75
RAIX00SS0005	5/16	14.5 X 17.5 X 20	2,07
RAIX00SS0006	3/8	16.5 X 19.5 X 20	2,12
RAIX00SS0008	1/2	19 X 22 X 20	2,25
RAIX00SS0010	5/8	24.5 X 27.5 X 20	2,50
RAIX00SS0012	3/4	30 X 33 X 20	3,24
RAIX00SS0016	1	35 X 38 X 25	4,62
RAIX00SS0020	1"1/4	44 X 47 X 25	5,99
RAIX00SS0024	1"1/2	52.5 X 55.5 X 30	7,24
RAIX00SS0032	2	64 X 67 X 30	8,75
RAIX00SS0040	2"1/2	81 X 85 X 30	15,10
RAIX00SS0048	3	99 X 103 X 30	19,72
RAIX00SS0064	4	118 X 122 X 30	24,21
RAIX00SS0080	5	160 X 166 X 40	27,41
RAIX00SS0096	6	186 X 192 X 40	37,73

**STUB-END AISI 316L**

STUB-END AISI 316L  
STUB-END AISI 316L



Ref.	1/16"	€
RCI10011008	1/2	33,38
RCI10011012	3/4	44,76
RCI10011016	1	77,63
RCI10011020	1"1/4	96,51
RCI10011024	1"1/2	108,50
RCI10011032	2	156,46
RCI10011040	2"1/2	172,33
RCI10011048	3	231,67
RCI10011064	4	188,37
RCI10011075	5	258,75
RCI10011090	6	398,48

**CODO 90° AISI 316L**

90° ELBOW AISI 316L  
 COUDE 90° AISI 316L



Ref.		€
RCI20901008	1/2	14,40
RCI20901012	3/4	17,60
RCI20901016	1	27,34
RCI20901020	1"1/4	43,47
RCI20901024	1"1/2	58,30
RCI20901032	2	86,16
RCI20901040	2"1/2	121,01
RCI20901048	3	155,25

**BRIDA PLANA DIN 2576 AISI 304L**

WELDING FLAT FLANGE DIN 2576 AISI 304L  
 BRIDE PLATE À SOUDER AISI 304L DIN 2576



Ref.		€
RCBI3241008	1/2	47,52
RCBI3241012	3/4	54,60
RCBI3241016	1	60,03
RCBI3241020	1"1/4	99,88
RCBI3241024	1"1/2	118,08
RCBI3241032	2	149,47
RCBI3241040	2"1/2	170,00
RCBI3241048	3	201,31
RCBI3241064	4	239,09
RCBI3241075	5	442,37
RCBI3241090	6	560,76

**BRIDA PLANA DIN 2576 AISI 316L**

WELDING FLAT FLANGE DIN 2576 AISI 316L  
 BRIDE PLATE À SOUDER AISI 316L DIN 2576



Ref.		€
RCBI3261008	1/2	56,41
RCBI3261012	3/4	79,52
RCBI3261016	1	86,16
RCBI3261020	1"1/4	131,45
RCBI3261024	1"1/2	150,59
RCBI3261032	2	203,12
RCBI3261040	2"1/2	227,27
RCBI3261048	3	268,32
RCBI3261064	4	323,09
RCBI3261075	5	579,11
RCBI3261090	6	788,61

**BRIDA CUELLO DIN 2633 AISI 304L**

NECK FLANGE DIN 2633 AISI 304L  
 BRIDE À COLLERETE



Ref.		€
RCBI3341008	1/2	50,72
RCBI3341012	3/4	69,78
RCBI3341016	1	78,83
RCBI3341020	1"1/4	104,62
RCBI3341024	1"1/2	116,61
RCBI3341032	2	150,51
RCBI3341040	2"1/2	174,66
RCBI3341048	3	225,63
RCBI3341064	4	292,39
RCBI3341075	5	379,40
RCBI3341090	6	499,19

**BRIDA ANSI SLIP-ON 150LB AISI316L**

ANSI SLIP-ON 150LB FLANGE AISI316L  
 BRIDE ANSI SLIP-ON 150LB AISI316L



Ref.		€
RCBI3101008	1/2	39,85
RCBI3101012	3/4	54,68
RCBI3101016	1	70,38
RCBI3101020	1"1/4	83,92
RCBI3101024	1"1/2	103,84
RCBI3101032	2	153,01
RCBI3101040	2"1/2	247,87
RCBI3101048	3	345,49
RCBI3101064	4	440,51
RCBI3101075	5	549,12
RCBI3101090	6	643,01

**BRIDA ANSI SLIP-ON 300LB AISI316L**

ANSI SLIP-ON 300LB FLANGE FLANGE AISI316L  
 BRIDE ANSI SLIP-ON 300LB AISI316L



Ref.		€
RCBI3201008	1/2	34,28
RCBI3201012	3/4	49,31
RCBI3201016	1	69,42
RCBI3201020	1"1/4	87,56
RCBI3201024	1"1/2	112,77
RCBI3201032	2	175,25
RCBI3201040	2"1/2	298,08
RCBI3201048	3	338,32
RCBI3201064	4	461,28
RCBI3201075	5	527,73
RCBI3201090	6	652,55

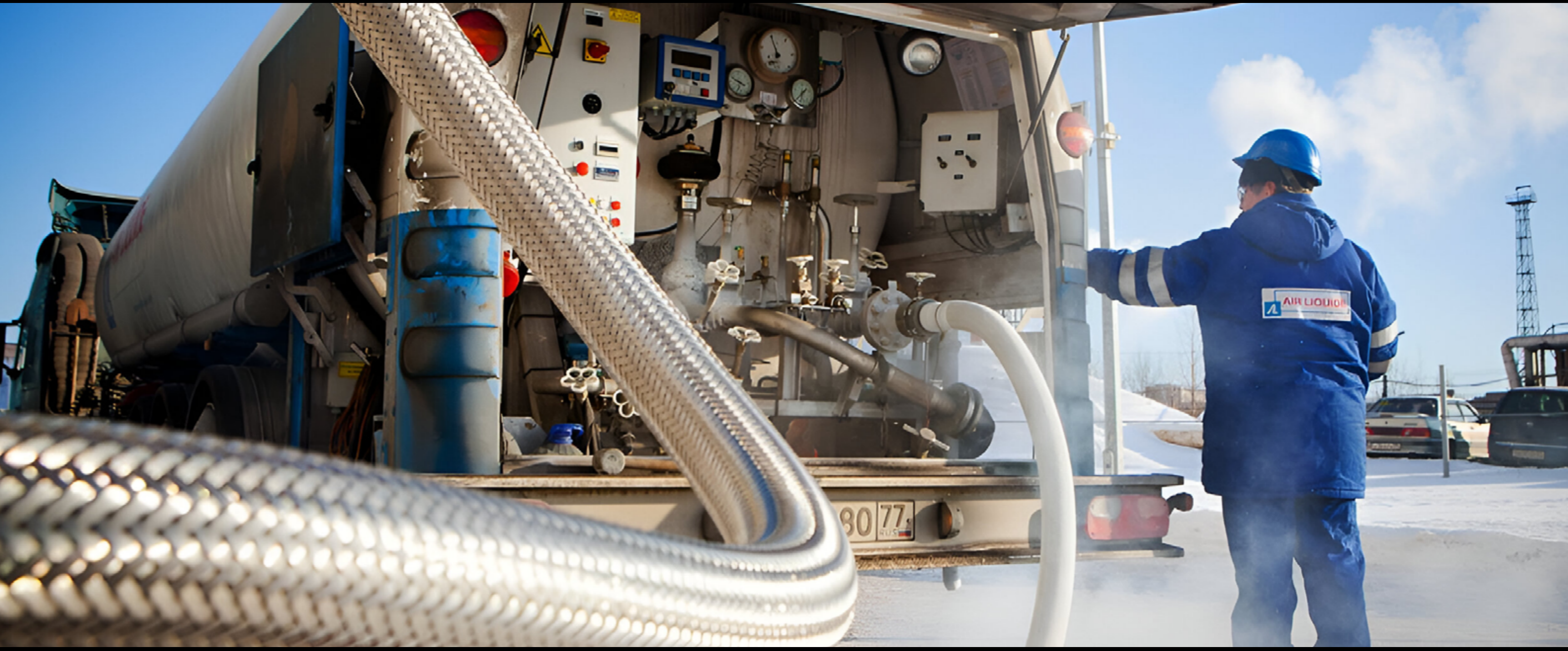

**FABRICACIÓN DE MANGUERAS INOXIDABLES.  
CONEXIONES ESPECIALES Y STANDARDS.  
TRABAJAMOS CON TODOS LOS SECTORES DE LA INDUSTRIA.**

**MANUFACTURE OF STAINLESS HOSES.  
SPECIAL AND STANDARD  
CONNECTIONS.  
WE WORK WITH ALL SECTORS OF  
THE INDUSTRY.**

**FABRICATION DE TUYAUX INOX.  
CONNEXIONS SPÉCIALES ET  
STANDARD.  
NOUS TRAVAILLONS AVEC TOUS LES  
SECTEURS DE L'INDUSTRIE.**

VINCKE  
DESDE  
SINCE  
DEPUIS

1983

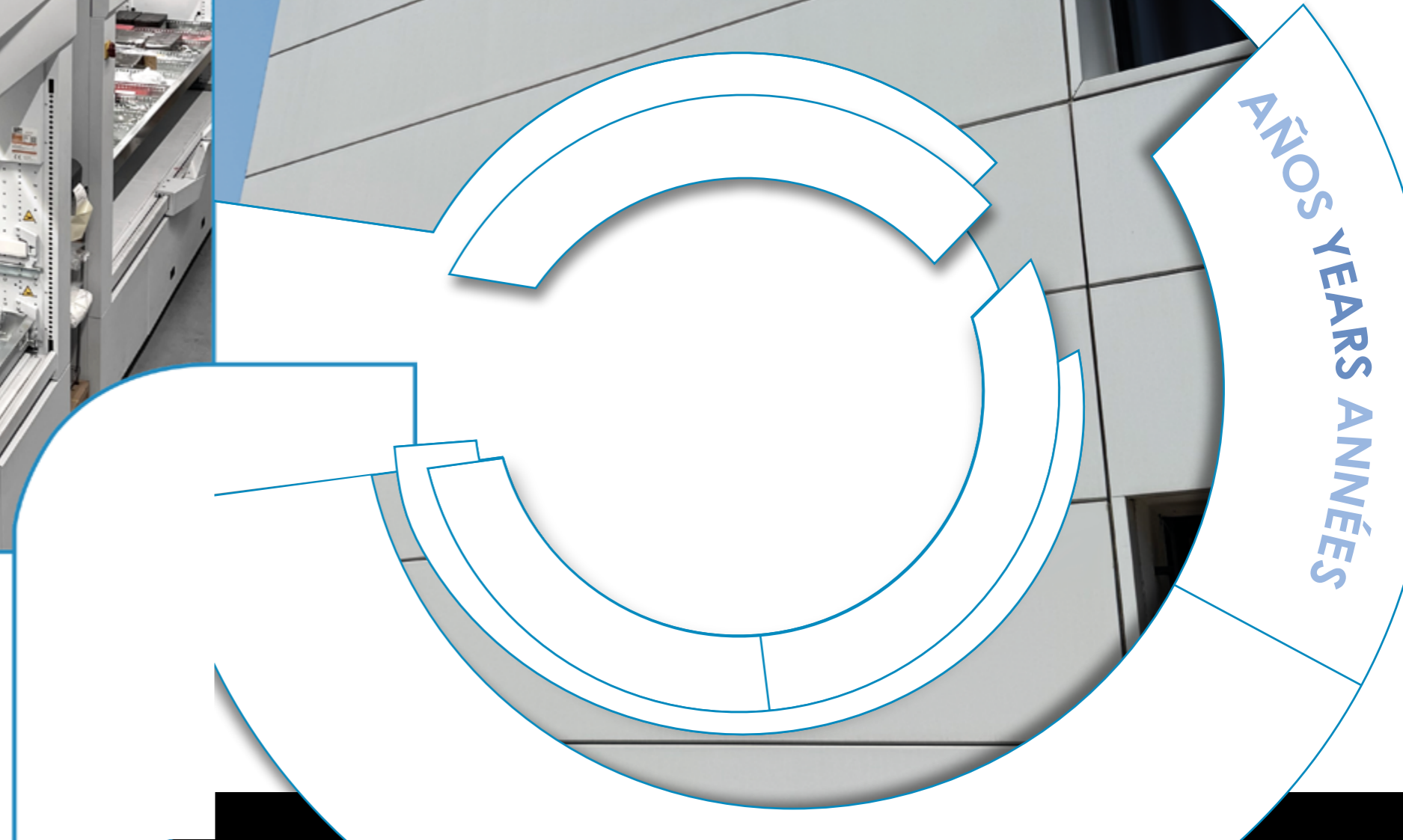



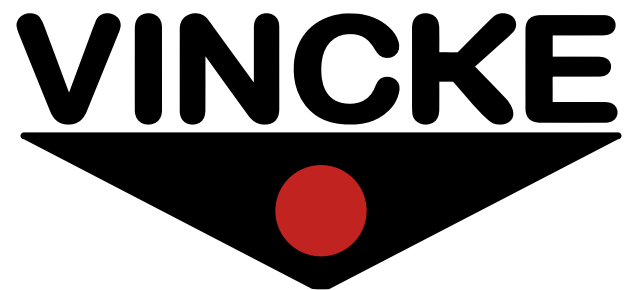

**TARIFA / PRICE LIST / TARIF**  
**AS0026**



*[vinckehydraulics.com](http://vinckehydraulics.com)*